



SmartLogger3000

User Manual

Issue 05

Date 2020-09-30

Copyright © Huawei Technologies Co., Ltd. 2020. All rights reserved.

No part of this document may be reproduced or transmitted in any form or by any means without prior written consent of Huawei Technologies Co., Ltd.

Trademarks and Permissions



HUAWEI and other Huawei trademarks are trademarks of Huawei Technologies Co., Ltd.

All other trademarks and trade names mentioned in this document are the property of their respective holders.

Notice

The purchased products, services and features are stipulated by the contract made between Huawei and the customer. All or part of the products, services and features described in this document may not be within the purchase scope or the usage scope. Unless otherwise specified in the contract, all statements, information, and recommendations in this document are provided "AS IS" without warranties, guarantees or representations of any kind, either express or implied.

The information in this document is subject to change without notice. Every effort has been made in the preparation of this document to ensure accuracy of the contents, but all statements, information, and recommendations in this document do not constitute a warranty of any kind, express or implied.

Huawei Technologies Co., Ltd.

Address: Huawei Industrial Base
Bantian, Longgang
Shenzhen 518129
People's Republic of China

Website: <https://e.huawei.com>

About This Document

Purpose





This document introduces the SmartLogger3000 (SmartLogger for short) and SmartModule1000 (SmartModule for short) in terms of installation, electrical connections, system operation and maintenance, and troubleshooting. Understand the SmartLogger and SmartModule features, functions, and safety precautions provided in this document before installing and operating the SmartLogger and SmartModule.

Intended Audience

This document is intended for photovoltaic (PV) plant operators and qualified electricians.

Symbol Conventions

The symbols that may be found in this document are defined as follows:

Symbol	Description
 DANGER	Indicates a hazard with a high level of risk which, if not avoided, will result in death or serious injury.
 WARNING	Indicates a hazard with a medium level of risk which, if not avoided, could result in death or serious injury.
 CAUTION	Indicates a hazard with a low level of risk which, if not avoided, could result in minor or moderate injury.
 NOTICE	Indicates a potentially hazardous situation which, if not avoided, could result in equipment damage, data loss, performance deterioration, or unanticipated results. NOTICE is used to address practices not related to personal injury.

Symbol	Description
 NOTE	Supplements the important information in the main text. NOTE is used to address information not related to personal injury, equipment damage, and environment deterioration.

Change History

Updates between document issues are cumulative. The latest document issue contains all changes made in previous issues.

Issue 05 (2020-09-30)

Updated [6.3.2 Setting Parameters for Connecting to the Management System](#).

Updated [6.3.5 Setting MBUS Parameters](#).

Added [8.15 How Do I Use Mobile Network Sharing?](#)

Added [C Port No. List](#).

Issue 04 (2020-03-11)

Updated [6.2.1 Preparations and WebUI Login](#).

Issue 03 (2020-01-10)

Added the description about the SmartModule.

Issue 02 (2019-12-18)

Updated [6 WebUI Operations](#).

Updated [9.1 Technical Specifications of the SmartLogger](#).

Issue 01 (2019-09-24)

This issue is used for first office application (FOA).

Contents

About This Document.....	ii
1 Safety Information.....	1
1.1 General Safety.....	1
1.2 Personnel Requirements.....	2
1.3 Electrical Safety.....	3
1.4 Installation Environment Requirements.....	4
1.5 Mechanical Safety.....	4
1.6 Commissioning.....	5
1.7 Maintenance and Replacement.....	5
2 Product Overview.....	6
2.1 SmartLogger.....	6
2.1.1 Model.....	6
2.1.2 Networking.....	8
2.1.3 Appearance.....	13
2.2 SmartModule.....	19
2.2.1 Model.....	19
2.2.2 Networking.....	21
2.2.3 Appearance.....	22
3 Device Installation.....	28
3.1 Checking Before Installation.....	28
3.2 Tools.....	28
3.3 Installation Requirements.....	29
3.4 Installing the SmartLogger.....	30
3.5 Installing the SmartLogger and SmartModule.....	32
3.6 Installing a Power Adapter.....	35
4 Cable Connections.....	37
4.1 Connecting Cables to the SmartLogger.....	37
4.1.1 Preparing Cables.....	37
4.1.2 Connecting a PE Cable.....	38
4.1.3 Connecting an RS485 Communications Cable.....	38
4.1.4 Connecting an MBUS Cable.....	40
4.1.5 Connecting a DI Signal Cable.....	43

4.1.6 Connecting the Output Power Cable.....	44
4.1.7 Connecting the AI Signal Cable.....	45
4.1.8 Connecting the DO Signal Cable.....	46
4.1.9 Connecting the Ethernet Cable.....	47
4.1.10 Connecting Fiber Jumpers.....	48
4.1.11 Installing a SIM Card and a 4G Antenna.....	49
4.1.12 Connecting the 24 V Input Power Cable.....	51
4.2 Connecting Cables to the SmartModule.....	51
4.2.1 Preparing Cables.....	51
4.2.2 Connecting the PE Cable.....	52
4.2.3 Connecting the Ethernet Cable.....	53
4.2.4 Connecting the 12 V Power Input Cable.....	53
4.2.5 Connecting the RS485 Communications Cable.....	54
4.2.6 Connecting the DI Signal Cable.....	55
4.2.7 Connecting the Output Power Cable.....	56
4.2.8 Connecting the AI Signal Cable.....	57
4.2.9 Connecting the PT Signal Cable.....	58
4.2.10 Connecting the 24 V Power Input Cable.....	59
5 System Operation.....	61
5.1 Check Before Power-on.....	61
5.2 Powering On the System.....	61
6 WebUI Operations.....	63
6.1 Introduction to WebUI.....	63
6.1.1 WebUI Layout.....	64
6.1.2 Icon Description.....	65
6.1.3 WebUI Menus.....	66
6.2 Device Commissioning.....	71
6.2.1 Preparations and WebUI Login.....	72
6.2.2 Commissioning Using Deployment Wizard.....	75
6.3 Parameter Settings.....	76
6.3.1 Setting User Parameters.....	76
6.3.2 Setting Parameters for Connecting to the Management System.....	78
6.3.3 Setting RS485 Communications Parameters.....	85
6.3.4 Setting Parameters for the Slave SmartLogger.....	87
6.3.5 Setting MBUS Parameters.....	88
6.3.6 Setting SUN2000 Parameters.....	93
6.3.6.1 Running Parameters.....	95
6.3.6.2 Tracking System.....	106
6.3.6.3 Characteristic Curves.....	107
6.3.7 Setting PID Module Parameters.....	107
6.3.7.1 PID Module Running Parameters.....	108
6.3.7.2 PID-PVBOX Running Parameters.....	112

6.3.7.3 PID-SSC Running Parameters.....	113
6.3.8 Setting Power Meter Parameters.....	113
6.3.8.1 Setting DL/T645 Power Meter Parameters.....	113
6.3.8.2 Setting Modbus-RTU Power Meter Parameters.....	114
6.3.9 Setting EMI Parameters.....	116
6.3.9.1 Setting Modbus-RTU EMI Parameters.....	116
6.3.9.2 Setting AI EMI Parameters.....	119
6.3.10 Setting STS Parameters.....	121
6.3.11 Setting IEC103 Device Parameters.....	122
6.3.12 Setting Parameters for a Custom Device.....	125
6.3.13 Setting IEC104 Device Parameters.....	127
6.3.14 Sets the parameters related to the poverty alleviation monitoring center.....	129
6.4 Power Grid Scheduling.....	130
6.4.1 Power Adjustment Description.....	131
6.4.2 Setting Active Power Control.....	131
6.4.3 Setting Reactive Power Control.....	138
6.4.4 Setting Export Limitation Parameters.....	145
6.4.5 Setting Parameters for Smart Reactive Power Compensation.....	147
6.4.6 Setting DRM Parameters.....	148
6.4.7 Setting Remote Shutdown.....	150
7 Device Maintenance.....	152
7.1 Routine Maintenance.....	152
7.2 Troubleshooting.....	152
7.3 Alarm List.....	156
7.4 WebUI Maintenance Operations.....	161
7.4.1 Upgrading the Device Firmware Version.....	161
7.4.2 Setting Security Parameters.....	162
7.4.3 Sending a System Maintenance Command.....	163
7.4.4 Exporting Device Logs.....	164
7.4.5 Starting an Onsite Test.....	165
7.4.6 Managing Licenses.....	166
7.4.7 Managing the SmartModule.....	167
7.4.8 Collecting Performance Data.....	167
7.4.9 Adjusting the Total Energy Yield.....	168
7.5 Device Disposal.....	168
8 FAQ.....	169
8.1 How Do I Connect the SmartLogger to the SUN2000 App or FusionSolar App?.....	169
8.2 How Do I Set FTP Parameters?.....	171
8.3 How Do I Set Email Parameters?.....	173
8.4 How Do I Change the SSID and Password of the Built-in WLAN?.....	176
8.5 How Do I Use DI Ports?.....	177
8.6 How Do I Use DO Ports?.....	178

8.7 How Do I Use the USB Port?.....	179
8.8 How Do I Change a Device Name?.....	182
8.9 How Do I Change the Communications Address?.....	182
8.10 How Do I Export Inverter Parameters?.....	183
8.11 How Do I Clear Alarms?.....	183
8.12 How Do I Enable the AI1 Port to Detect SPD Alarms?.....	184
8.13 Which Models of Power Meters and EMIs Are Supported by the SmartLogger?.....	184
8.14 How Do I Check the SIM Card Status?.....	187
8.15 How Do I Use Mobile Network Sharing?.....	189
9 Technical Specifications.....	191
9.1 Technical Specifications of the SmartLogger.....	191
9.2 Technical Specifications of the SmartModule.....	196
A Product User Lists.....	198
B Domain Name List of Management Systems.....	200
C Port No. List.....	201
D Acronyms and Abbreviations.....	203

1 Safety Information

1.1 General Safety

Statement

Before installing, operating, and maintaining the equipment, read this document and observe all the safety instructions on the equipment and in this document.

The "NOTICE", "CAUTION", "WARNING", and "DANGER" statements in this document do not cover all the safety instructions. They are only supplements to the safety instructions. Huawei will not be liable for any consequence caused by the violation of general safety requirements or design, production, and usage safety standards.

Ensure that the equipment is used in environments that meet its design specifications. Otherwise, the equipment may become faulty, and the resulting equipment malfunction, component damage, personal injuries, or property damage are not covered under the warranty.

Follow local laws and regulations when installing, operating, or maintaining the equipment. The safety instructions in this document are only supplements to local laws and regulations.

Huawei will not be liable for any consequences of the following circumstances:

- Operation beyond the conditions specified in this document
- Installation or use in environments which are not specified in relevant international or national standards
- Unauthorized modifications to the product or software code or removal of the product
- Failure to follow the operation instructions and safety precautions on the product and in this document
- Equipment damage due to force majeure, such as earthquakes, fire, and storms
- Damage caused during transportation by the customer
- Storage conditions that do not meet the requirements specified in this document

General Requirements

 **DANGER**

Do not work with power on during installation.

- After installing the equipment, remove idle packing materials such as cartons, foam, plastics, and cable ties from the equipment area.
- In the case of a fire, immediately leave the building or the equipment area, and turn on the fire alarm bell or make an emergency call. Do not enter the building on fire in any case.
- Do not scrawl, damage, or block any warning label on the equipment.
- Tighten the screws using tools when installing the equipment.
- Understand the components and functioning of a grid-tied PV power system and relevant local standards.

Personal Safety

- If there is a probability of personal injury or equipment damage during operations on the equipment, immediately stop the operations, report the case to the supervisor, and take feasible protective measures.
- Use tools correctly to avoid hurting people or damaging the equipment.

1.2 Personnel Requirements

- Personnel who plan to install or maintain Huawei equipment must receive thorough training, understand all necessary safety precautions, and be able to correctly perform all operations.
- Only qualified professionals or trained personnel are allowed to install, operate, and maintain the equipment.
- Only qualified professionals are allowed to remove safety facilities and inspect the equipment.
- Personnel who will operate the equipment, including operators, trained personnel, and professionals, should possess the local national required qualifications in special operations such as high-voltage operations, working at heights, and operations of special equipment.
- Only professionals or authorized personnel are allowed to replace the equipment or components (including software).

 **NOTE**

- Professionals: personnel who are trained or experienced in equipment operations and are clear of the sources and degree of various potential hazards in equipment installation, operation, and maintenance
- Trained personnel: personnel who are technically trained, have required experience, are aware of possible hazards on themselves in certain operations, and are able to take protective measures to minimize the hazards on themselves and other people
- Operators: operation personnel who may come in contact with the equipment, except trained personnel and professionals

1.3 Electrical Safety

Grounding

- For the equipment that needs to be grounded, install the ground cable first when installing the equipment and remove the ground cable last when removing the equipment.
- Do not damage the ground conductor.
- Do not operate the equipment in the absence of a properly installed ground conductor.
- Ensure that the equipment is connected permanently to the protective ground. Before operating the equipment, check its electrical connection to ensure that it is securely grounded.

General Requirements



Before connecting cables, ensure that the equipment is intact. Otherwise, electric shocks or fire may occur.

-
- Ensure that all electrical connections comply with local electrical standards.
 - Ensure that the cables you prepared meet local regulations.

AC and DC Power



Do not connect or disconnect power cables with power on. Transient contact between the core of the power cable and the conductor will generate electric arcs or sparks, which may cause fire or personal injury.

-
- Before making electrical connections, switch off the disconnecter on the upstream device to cut off the power supply if people may contact energized components.
 - Before connecting a power cable, check that the label on the power cable is correct.
 - If the equipment has multiple inputs, disconnect all the inputs before operating the equipment.

Cabling

- When routing cables, ensure that a distance of at least 30 mm exists between the cables and heat-generating components or areas. This prevents damage to the insulation layer of the cables.

- Bind cables of the same type together. When routing cables of different types, ensure that they are at least 30 mm away from each other.

ESD

When installing, operating, and maintaining the equipment, comply with the ESD protection regulations and wear the ESD clothing, gloves, and wrist strap.

1.4 Installation Environment Requirements

- Ensure that the equipment is installed in a well ventilated environment.
- Do not expose the equipment to flammable or explosive gas or smoke. Do not perform any operation on the equipment in such environments.

1.5 Mechanical Safety

Using Ladders

- Use wooden or fiberglass ladders when you need to perform live working at heights.
- When a step ladder is used, ensure that the pull ropes are secured and the ladder is held firm.
- Before using a ladder, check that it is intact and confirm its load bearing capacity. Do not overload it.
- Ensure that the wider end of the ladder is at the bottom, or protective measures have been taken at the bottom to prevent the ladder from sliding.
- Ensure that the ladder is securely positioned. The recommended angle for a ladder against the floor is 75 degrees, as shown in the following figure. An angle rule can be used to measure the angle.

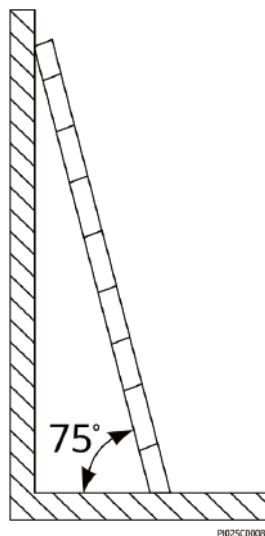

- When climbing a ladder, take the following precautions to reduce risks and ensure safety:
 - Keep your body steady.

- Do not climb higher than the fourth rung of the ladder from the top.
- Ensure that your body's center of gravity does not shift outside the legs of the ladder.

Drilling Holes

When drilling holes into a wall or floor, observe the following safety precautions:

- Wear goggles and protective gloves when drilling holes.
- When drilling holes, protect the equipment from shavings. After drilling, clean up any shavings that have accumulated inside or outside the equipment.

Moving Heavy Objects

- Be cautious to avoid injury when moving heavy objects.

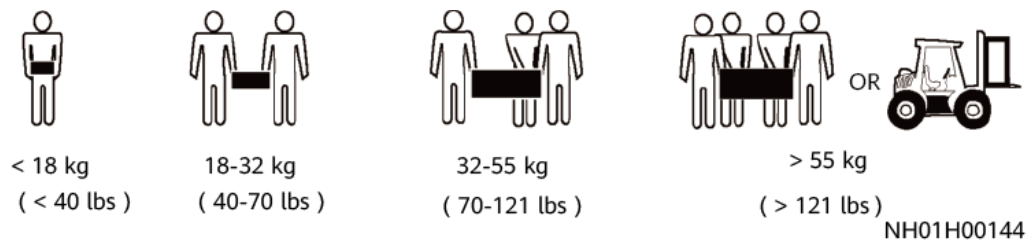

- When moving the equipment by hand, wear protective gloves to prevent injuries.

1.6 Commissioning

When the equipment is powered on for the first time, ensure that professional personnel set parameters correctly. Incorrect settings may result in inconsistency with local certification and affect the normal operation of the equipment.

1.7 Maintenance and Replacement

- Maintain the equipment with sufficient knowledge of this document and using proper tools and testing equipment.
- If the equipment is faulty, contact your dealer.
- The equipment can be powered on only after all faults are rectified. Failing to do so may escalate faults or damage the equipment.

2 Product Overview

2.1 SmartLogger

2.1.1 Model

Model Description

This document covers the following SmartLogger models:

- SmartLogger3000A01CN
- SmartLogger3000B01CN
- SmartLogger3000B03CN
- SmartLogger3000A01EU
- SmartLogger3000A03EU
- SmartLogger3000B02EU
- SmartLogger3000A01NH
- SmartLogger3000B00NH
- SmartLogger3000A01KR
- SmartLogger3000A01AU
- SmartLogger3000A00GL

Figure 2-1 Model

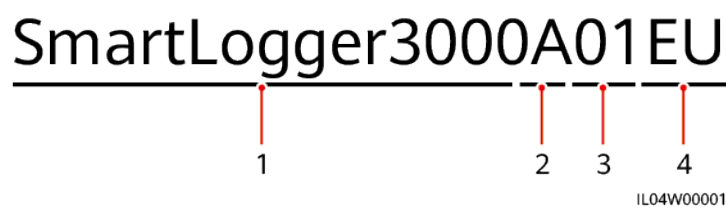

Table 2-1 Model Description

No.	Meaning	Description
1	Series	SmartLogger3000: data collector
2	Hardware ID	<ul style="list-style-type: none">• A: does not support fiber networking and can connect to a maximum of 80 solar inverters.• B: supports fiber networking and a maximum of 150 solar inverters.
3	Feature ID	<ul style="list-style-type: none">• 00: does not support 4G networking or MBUS communication.• 01: supports 4G networking, but not MBUS communication.• 02: supports MBUS communication, but not 4G networking.• 03: supports 4G networking and MBUS communication.
4	Region	<ul style="list-style-type: none">• CN: China• EU: Europe• NH: Japan• KR: South Korea• AU: Australia• GL: Global

Model Identification

You can view the SmartLogger model and communication mode on the nameplate.

Figure 2-2 Nameplate

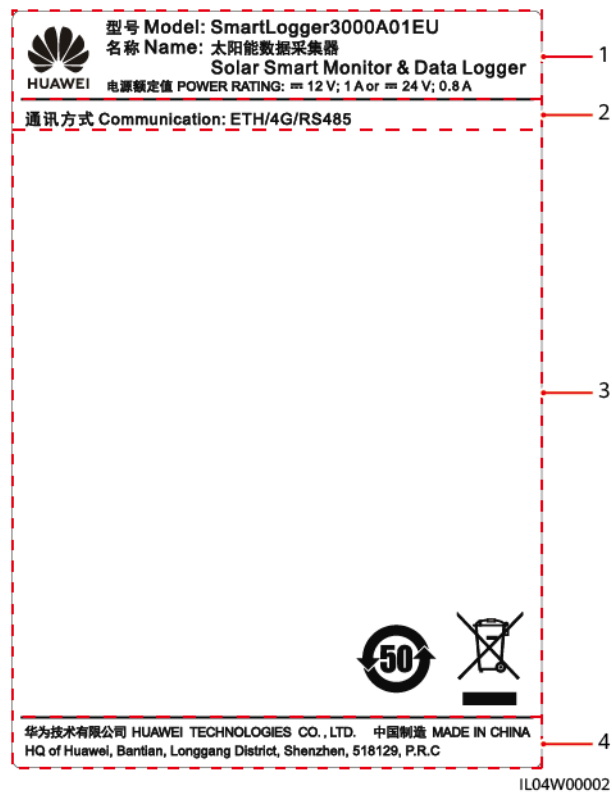

- | | |
|--|---|
| (1) Trademark, product model, and power rating | (2) Communications mode |
| (3) Compliance symbols | (4) Company name and place of manufacture |

NOTE

The nameplate figure is for reference only.

2.1.2 Networking

Function

The SmartLogger monitors and manages PV power systems. It converges all ports, converts protocols, collects and stores data, and centrally monitors and maintains the devices in PV power systems.

Network Application

The SmartLogger applies to PV power systems. It supports the following:

- Local operations on the SmartLogger using the mobile phone app through the built-in WLAN
- RS485 networking, which enables the SmartLogger to connect to:
 - Huawei devices such as solar inverters and PID modules

- Third-party solar inverters, environment monitoring instruments (EMIs), transformer stations, and power meters that use the Modbus-RTU protocol
- Power meters that use the DL/T645 protocol
- Devices that use the IEC103 protocol
- MBUS networking, which enables the SmartLogger to connect to Huawei solar inverters and PID-PVBOXs that support MBUS communication
- Connection to management systems:
 - Connects to a management system that uses the Modbus TCP protocol over a wired or wireless network.
 - Connects to a management system that uses the IEC104 protocol in the LAN over a wired network.

NOTE

The SmartLogger cannot be connected to a management system that uses the IEC104 protocol over a 4G/3G/2G or LTE dedicated network.

Typical Networking Scenarios

- The SmartLogger supports the following wired networks: fiber ring network, fiber star network, and Ethernet star network.

Figure 2-3 Fiber ring network

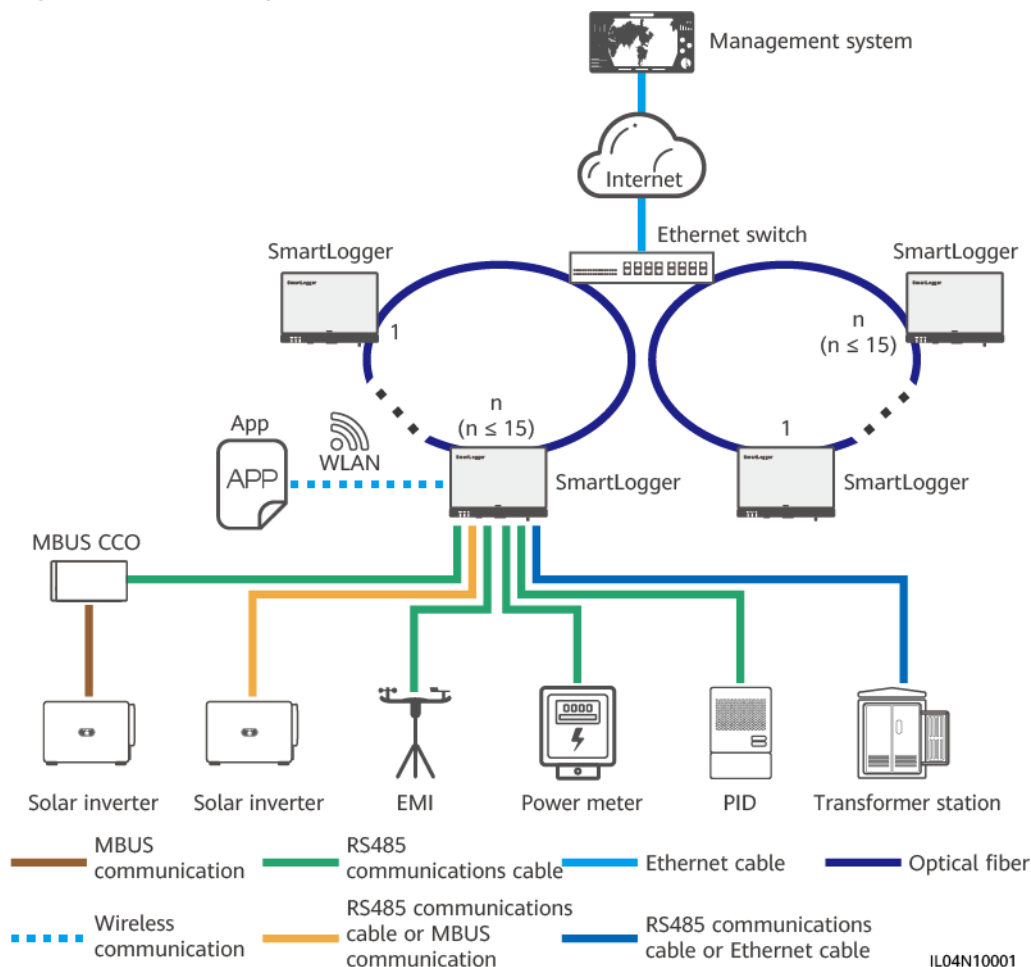

IL04N10001

NOTE

- A maximum of 15 SmartLoggers can be connected to form a fiber ring network. Each SmartLogger can connect to devices such as solar inverters, EMIs, and power meters.
- Multiple fiber ring networks can be connected to the management system through an Ethernet switch.

Figure 2-4 Fiber or Ethernet star network

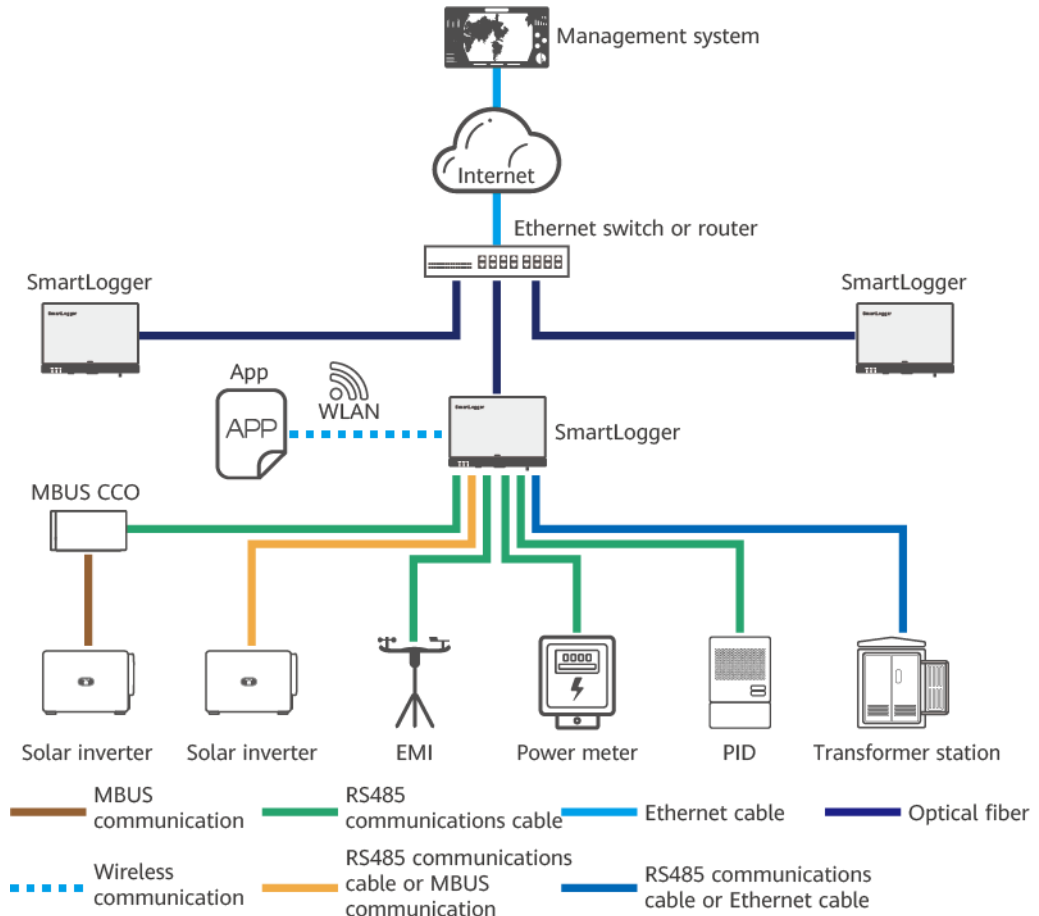

IL04N10002

NOTE

- Multiple SmartLoggers can be connected to the management system through an Ethernet switch.
- When the SmartLogger connects to an Ethernet switch over optical fibers, the maximum communication distance is 12 km (with the 100M optical module) or 10 km (with the 1000M optical module). The maximum communication distance is 100 m when an Ethernet cable is used for connection.
- The SmartLogger supports the following wireless networks: 4G/3G/2G networking and LTE dedicated networking.

Figure 2-5 4G networking

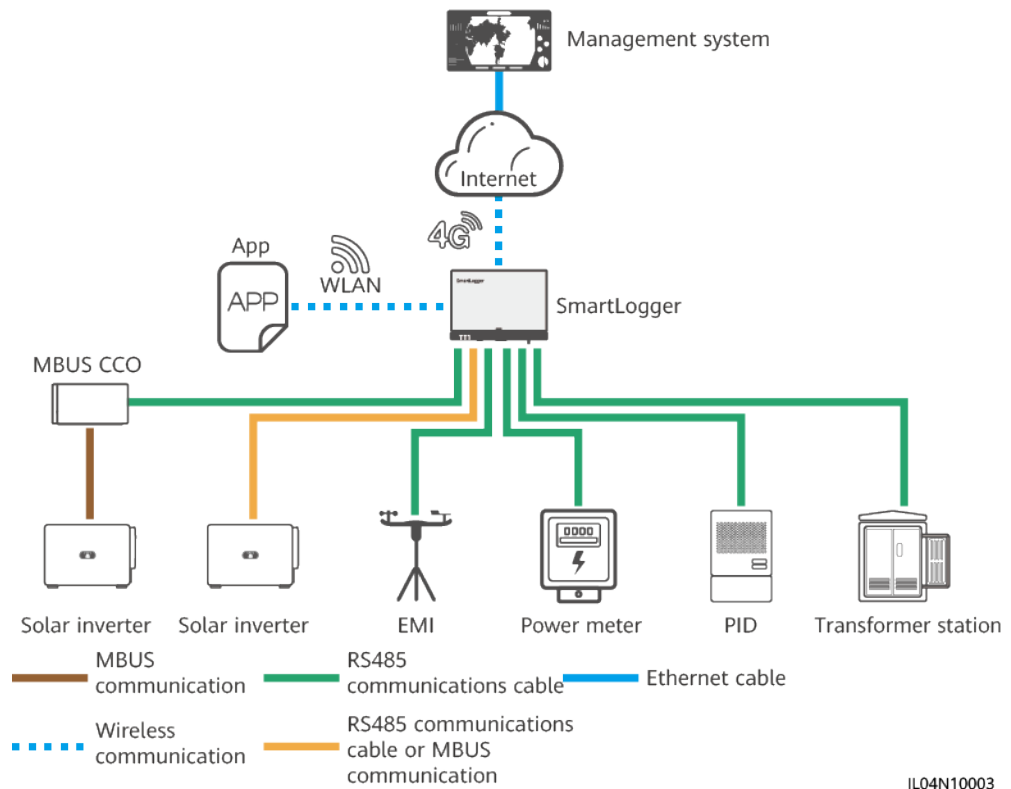
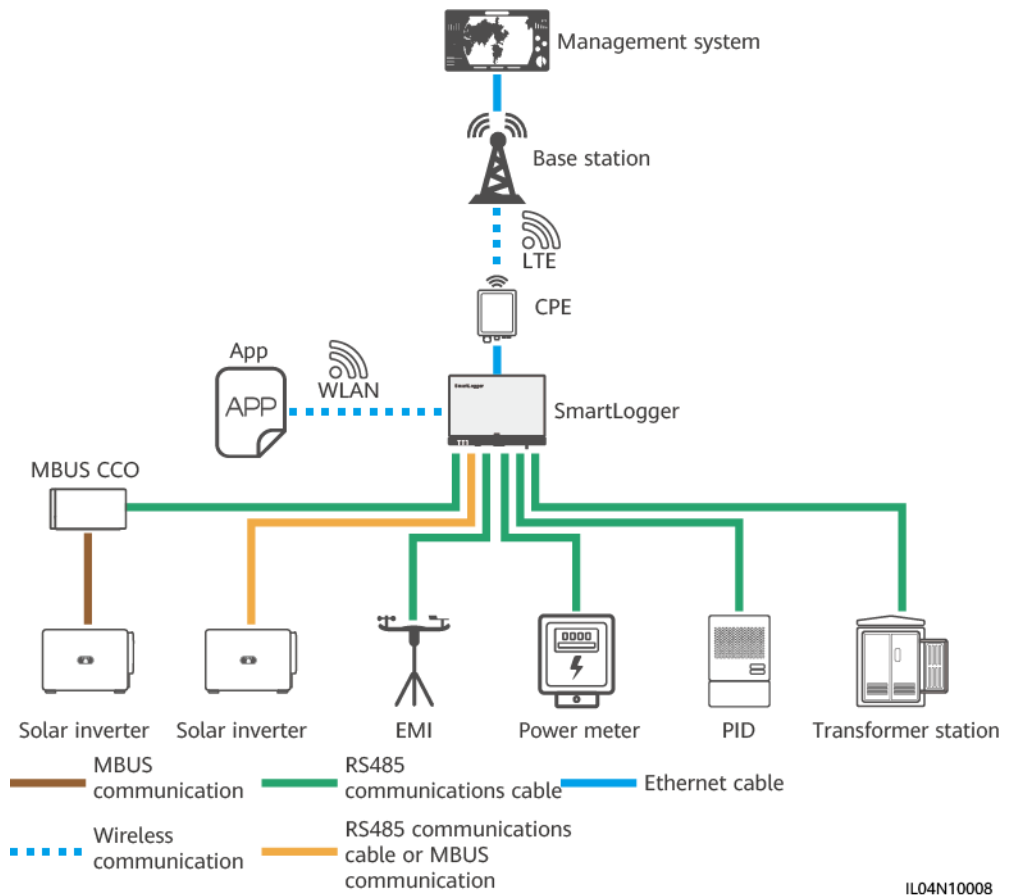

Figure 2-6 LTE dedicated networking



NOTE

- The WAN port of the SmartLogger connects to the customer-premises equipment (CPE) through the power over Ethernet (PoE) module and PoE SPD.
- The IP addresses of the SmartLogger and CPE must be on the same network segment.

2.1.3 Appearance

Appearance

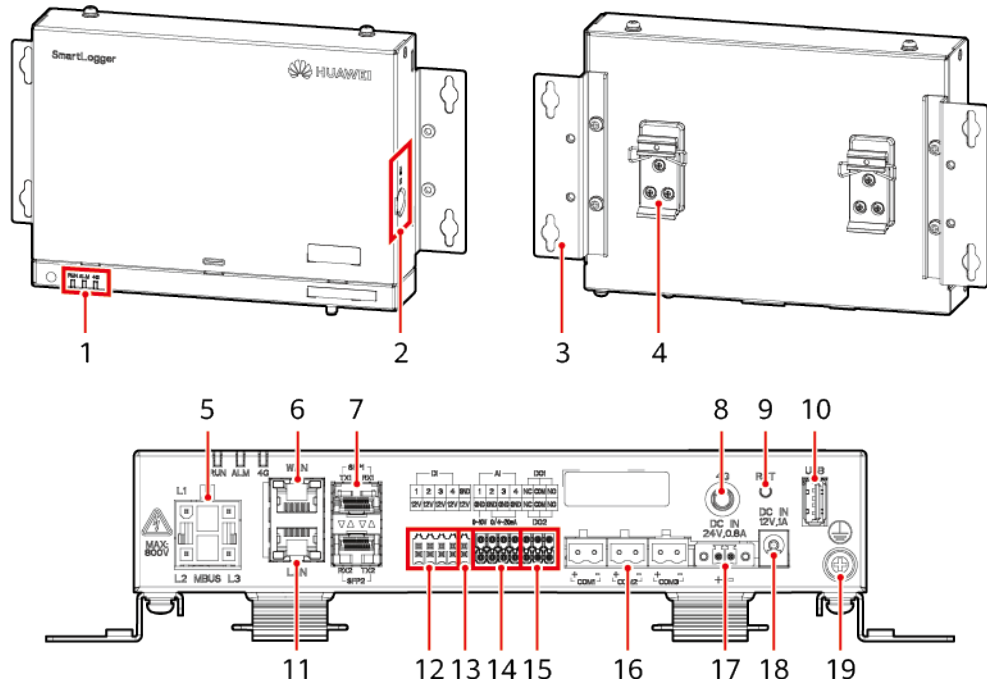

Figure 2-7 SmartLogger



IL04W00003

- | | | |
|------------------------------|----------------------------|----------------------------|
| (1) LED indicators | (2) SIM card slot | (3) Mounting ear |
| (4) Guide rail clamp | (5) MBUS port | (6) GE port (WAN) |
| (7) SFP ports | (8) 4G antenna port | (9) RST button |
| (10) USB port | (11) GE port (LAN) | (12) DI ports |
| (13) 12 V output power port | (14) AI ports | (15) DO ports |
| (16) COM ports | (17) 24 V input power port | (18) 12 V input power port |
| (19) Protective ground point | | |

Indicators

Indicator	Status	Description	
Running indicator (RUN) 	Green off	The SmartLogger is not powered on.	
	Blinking green slowly (on for 1s and then off for 1s)	The communication with the management system is normal.	
	Blinking green fast (on for 0.125s and then off for 0.125s)	The communication with the management system is interrupted.	
Alarm/ Maintenance indicator (ALM) 	Alarm status	Red off	No system alarm is raised.
		Blinking red slowly (on for 1s and then off for 4s)	The system raises a warning alarm.
		Blinking red fast (on for 0.5s and then off for 0.5s)	The system raises a minor alarm.
		Steady red	The system raises a major alarm.
	Maintenance status	Green off	No local maintenance is in progress.
		Blinking green slowly (on for 1s and then off for 1s)	Local maintenance is in progress.
		Blinking green fast (on for 0.125s and then off for 0.125s)	Local maintenance fails or the connection to the app is to be set up.
		Steady green	Local maintenance succeeds.
4G indicator (4G) 	Green off	The 4G/3G/2G networking function is not enabled.	
	Blinking green slowly (on for 1s and then off for 1s)	Dial-up through the 4G/3G/2G network is successful.	
	Blinking green fast (on for 0.125s and then off for 0.125s)	The 4G/3G/2G network is not connected or the communication is interrupted.	

NOTE

- Local maintenance refers to the operations performed by connecting a USB flash drive to the SmartLogger USB port, such as full data import and export using a USB flash drive, and by connecting the SmartLogger to the FusionSolar app or SUN2000 app over the built-in WLAN hotspot.
- If an alarm and local maintenance happen concurrently, the alarm/maintenance indicator shows the local maintenance state first. After local maintenance ends, the indicator shows the alarm state.

Communications Ports

- GE ports: Ethernet ports, including one WAN port and one LAN port

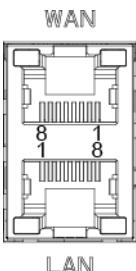
Appearance	GE Port		Description
	Pins	Pin 1	1+
		Pin 2	1-
		Pin 3	2+
		Pin 4	3+
		Pin 5	3-
		Pin 6	2-
		Pin 7	4+
		Pin 8	4-
	Indicators	Green indicator	If the indicator is steady green, the line is normal.
		Yellow indicator	If the indicator blinks yellow, data communication is normal.

- SFP ports: include two Ethernet optical ports (SFP1 and SFP2), support access of 100M/1000M SFP or eSFP optical modules, and implement ring networking using RSTP or STP.

NOTE

- If RSTP is used, fiber ring protection can be completed within 10 seconds. If STP is used, fiber ring protection can be completed within 60 seconds.
- The SFP1 and SFP2 ports are Ethernet optical ports and work on the same network segment as the WAN port.

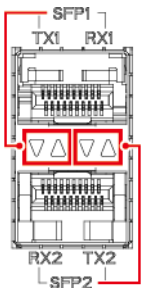
Appearance	SFP Port		Description	
	SFP1	TX1	Transmit port	
		RX1	Receive port	
	SFP2	RX2	Receive port	
		TX2	Transmit port	
	Indicators	Green indicator	If the indicator is steady green, the line is normal.	
		Yellow indicator	If the indicator blinks yellow, data communication is normal.	

- DI ports: digital input ports, which are used to connect to DI power grid scheduling commands or alarm signals.

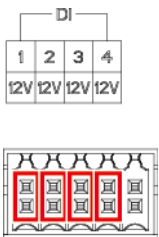
Appearance	DI Port		Description
	DI1	1	Can connect to four passive dry contact signals.
		12V	
	DI2	2	
		12V	
	DI3	3	
		12V	
	DI4	4	
		12V	

- AI ports: analog input ports, which are used to connect to AI power grid scheduling commands or environment monitoring sensors.

Appearance	AI Port		Description
	AI1	1	Supports one channel of voltage-type (0–10 V) AI signals.
		GND	
	AI2	2	Support three channels of current-type (0–20 mA or 4–20 mA) AI signals.
		GND	
	AI3	3	
		GND	
	AI4	4	
		GND	

- DO ports: digital output ports, supporting two relay outputs. A DO port supports a maximum of 12 V signal voltage.

Appearance	DO Port		Description
	DO1	NC	<ul style="list-style-type: none"> • The NC/COM is a normally closed contact. • The NO/COM is a normally open contact.
		COM	
		NO	
	DO2	NC	
		COM	
		NO	

- USB port: supports USB2.0 for connecting to a USB flash drive.

Appearance	USB Port	Description
	USB	After a USB flash drive is inserted into the USB port, you can perform local maintenance operations on the SmartLogger, such as firmware upgrade and data export.

- COM ports: RS485 communications port, supporting three independent RS485 channels and the access of devices that comply with the Modbus-RTU, IEC103, or DL/T645 protocol.

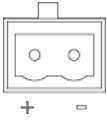
Appearance	COM Port		Description
	COM1, COM2, and COM3	+	RS485A, RS485 differential signal+
		-	RS485B, RS485 differential signal-

Power Ports

- Input power ports: There are two input power ports.

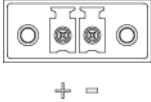
Appearance	Input Power Port		Description
DC IN 12V,1A 	12 V input power port	DC IN 12 V, 1 A	DC2.0 input port, which supports 12 V DC input and is used to connect to a power adapter.
DC IN 24V,0.8A 	24 V input power port	DC IN 24 V, 0.8 A	2-pin cord end terminal, which supports 24 V DC input. When the device connects to the power supply through the 12 V input power port, this port can be used as the 12 V output power port.

- 12 V output power port: There is one 12 V output power port. Its maximum output capability is 0.1 A. The port is used to drive the coil of the intermediate relay in the export limitation or audible and visual alarm scenario.

NOTICE

Select the intermediate relay with a free-wheeling diode in the coil. Otherwise, the device may be damaged.

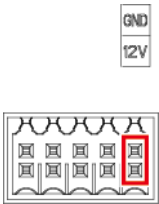
Appearance	Output Power Port		Description
	12 V output power port	GND	Power supply-
		12V	Power supply+

Button

Button	Operation	Function Description
RST button RST 	Hold down the button for 1s to 3s.	When WLAN is set to OFF in idle state , hold down the RST button for 1s to 3s to power on the WLAN module. The alarm/maintenance indicator (ALM) then blinks green quickly for 2 minutes (other indicators are off) and the SmartLogger waits for connecting to the app. If the app is not connected, the WLAN module is automatically powered off after it is powered on for 4 hours.
	Hold down the button for more than 60s.	Within 3 minutes after the SmartLogger is powered on, hold down the RST button for more than 60s to restart the SmartLogger and restore factory settings.

Dimensions

Figure 2-8 Dimensions

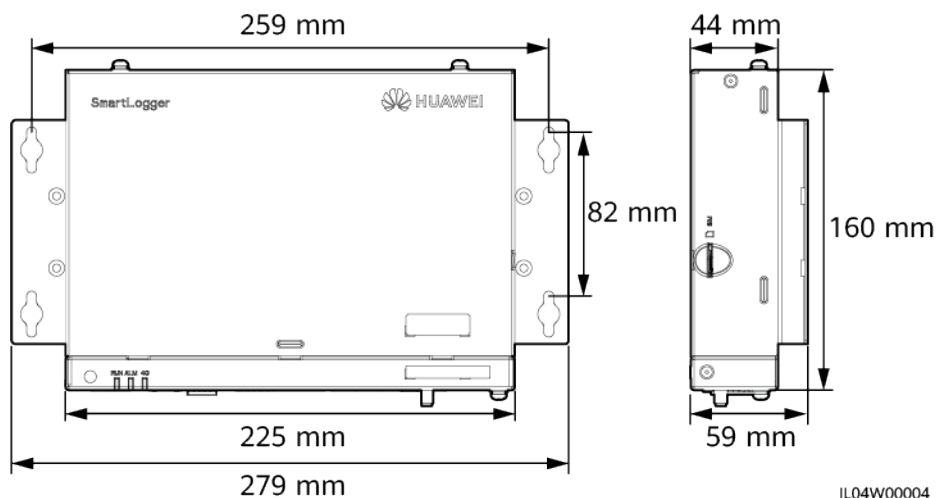

IL04W00004

2.2 SmartModule

2.2.1 Model

Model description

This document covers the following SmartModule model:

- SmartModule1000A01

Figure 2-9 Model

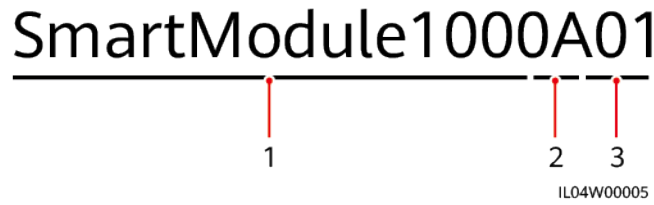

Table 2-2 Model description

No.	Meaning	Description
1	Series	SmartModule1000: expansion module
2	Hardware ID	A: version A
3	Feature ID	01: SmartLogger scenario

Model Identification

You can view the SmartModule model on the nameplate.

Figure 2-10 Nameplate

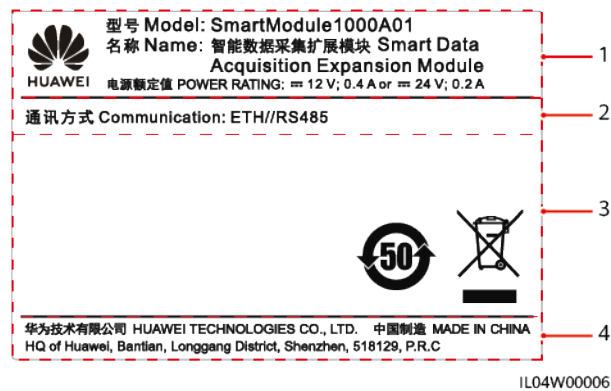

- (1) Trademark, product model, and power rating
- (2) Communications mode
- (3) Compliance symbols
- (4) Company name and place of manufacture

NOTE

The nameplate figure is for reference only.

2.2.2 Networking

Function

The SmartModule is a dedicated device for the monitoring and management platform of PV power systems. It converges ports, converts protocols, and collects data for devices in PV power systems. It extends ports for the SmartLogger.

Networking

The SmartModule applies to PV power systems. It supports the following:

- RS485 networking, which enables the SmartModule to connect to:
 - Huawei devices such as solar inverters and PID modules
 - Third-party solar inverters, EMIs, transformer stations, and power meters that use the Modbus-RTU protocol
 - Power meters that use the DL/T645 protocol
 - Devices that use the IEC103 protocol
- The SmartLogger can be connected over Ethernet.

Figure 2-11 Networking

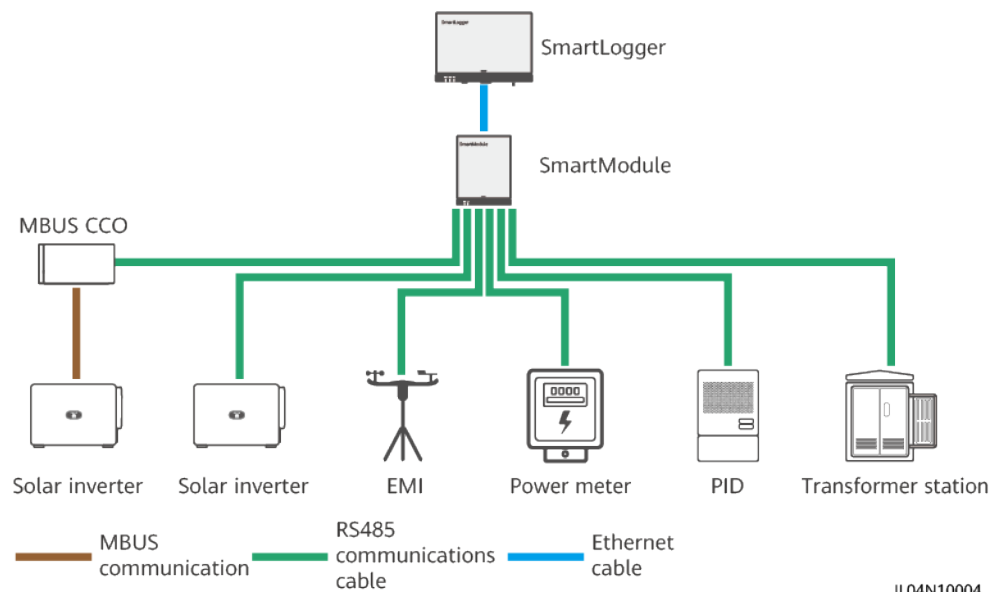

2.2.3 Appearance

Appearance

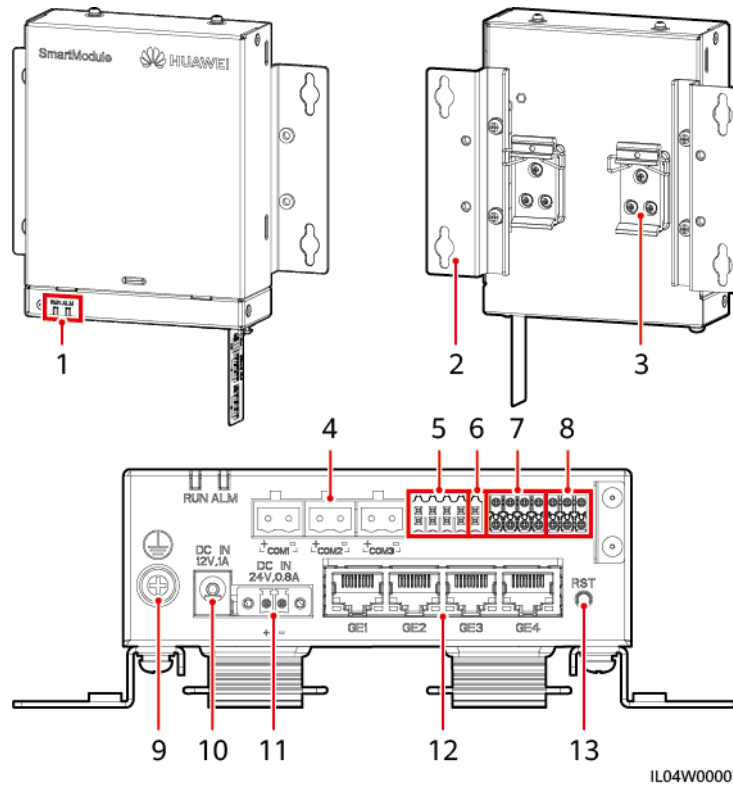

Figure 2-12 Appearance



- | | | |
|----------------------------|----------------------------|-----------------------------|
| (1) LED indicators | (2) Mounting ear | (3) Guide rail clamp |
| (4) COM ports | (5) DI ports | (6) 12 V power output port |
| (7) AI ports | (8) PT ports | (9) Protective ground point |
| (10) 12 V power input port | (11) 24 V power input port | (12) GE ports |
| (13) RST button | | |

IL04W00007

Indicators

Indicator	Status	Description	
Running indicator (RUN) 	Green off	The SmartModule is not powered on.	
	Blinking green slowly (on for 1s and then off for 1s)	The communication with the SmartLogger is normal.	
	Blinking green fast (on for 0.125s and then off for 0.125s)	The communication with the SmartLogger is interrupted.	
Alarm/Maintenance indicator (ALM) 	Alarm status	Red off	No alarm is raised for the SmartModule.
		Blinking red slowly (on for 1s and then off for 4s)	The SmartModule is running in non-encryption status.
		Blinking red fast (on for 0.5s and then off for 0.5s)	The SmartModule digital certificate is invalid.
		Steady red	Reserved.

Communications Ports

- GE ports: four Ethernet electrical ports. Connect the LAN port of the SmartLogger to one GE port of the SmartModule using an Ethernet cable. The SmartModule obtains an IP address from the DHCP server and automatically registers with the SmartLogger. The SmartLogger can use all communications ports of the SmartModule.

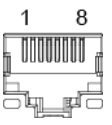
Appearance	GE Port		Description
	Pins	Pin 1	1+
		Pin 2	1-
		Pin 3	2+
		Pin 4	3+
		Pin 5	3-
		Pin 6	2-
		Pin 7	4+
		Pin 8	4-
	Indicators	Green indicator	If the indicator is steady green, the line is normal.
		Yellow indicator	If the indicator blinks yellow, data communication is normal.

- DI ports: digital input ports, which are used to connect to DI power grid scheduling commands or alarm signals.

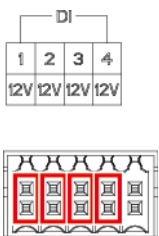
Appearance	DI Port		Description
	DI1	1	Can connect to four passive dry contact signals.
		12V	
	DI2	2	
		12V	
	DI3	3	
		12V	
	DI4	4	
		12V	

- AI ports: analog input ports, which are used to connect to AI power grid scheduling commands or environment monitoring sensors.

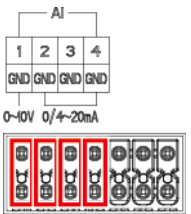
Appearance	AI Port		Description
 <p>The diagram shows terminal connections for AI1 (terminals 1, 2, 3, 4) and AI2-4 (terminals 5-8). It specifies 0-10V for AI1 and 0/4-20mA for AI2-4. The photo shows the physical ports with red highlights on the AI2-4 terminals.</p>	AI1	1	Supports one channel of voltage-type (0-10 V) AI signals.
		GND	
	AI2	2	Support three channels of current-type (0-20 mA or 4-20 mA) AI signals.
		GND	
	AI3	3	
		GND	
	AI4	4	
		GND	

- PT ports: can connect to two PT100/PT1000 temperature sensors.

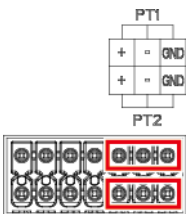
Appearance	PT Port		Description	
 <p>The diagram shows terminal connections for PT1 and PT2. PT1 terminals are labeled +, -, and GND. PT2 terminals are also labeled +, -, and GND. The photo shows the physical ports with red highlights on the PT1 and PT2 terminals.</p>	PT1	+	Can connect to a three-wire or two-wire PT100/PT1000 temperature sensor.	
		-		
		GND		
	PT2	+	<ul style="list-style-type: none"> • Three-wire: cable length < 2 m for PT100; cable length < 20 m for PT1000 • Two-wire: cable length < 2 m for a PT temperature sensor 	
		-		
		GND		

- COM ports: RS485 communications port, supporting three independent RS485 channels and the access of devices that comply with the Modbus-RTU, IEC103, or DL/T645 protocol.

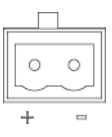
Appearance	COM Port		Description
 <p>The diagram shows terminal connections for COM1, COM2, and COM3. Terminals are labeled + and -.</p>	COM1, COM2, and COM3	+	RS485A, RS485 differential signal+
		-	RS485B, RS485 differential signal-

Power Ports

- Input power ports: There are two input power ports.

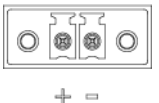
Appearance	Input Power Port		Description
<p>DC IN 12V,1A</p> 	12 V input power port	DC IN 12 V, 1 A	DC2.0 input port, which supports 12 V DC input and is used to connect to a power adapter.
<p>DC IN 24V,0.8A</p>  <p>+ -</p>	24 V input power port	DC IN 24 V, 0.8 A	2-pin cord end terminal, which supports 24 V DC input. When the device connects to the power supply through the 12 V input power port, this port can be used as the 12 V output power port.

- 12 V output power port: There is one 12 V output power port. Its maximum output capability is 0.1 A. The port is used to drive the coil of the intermediate relay in the export limitation or audible and visual alarm scenario.

NOTICE

Select the intermediate relay with a free-wheeling diode in the coil. Otherwise, the device may be damaged.

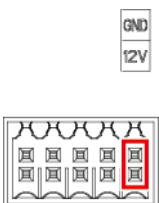
Appearance	Output Power Port		Description
	12 V output power port	GND	Power supply-
		12V	Power supply+

Button

Button	Operation	Function Description
RST button RST 	Hold down the button for 3s to 10s.	If the Communication using expired certificate function is disabled for the SmartLogger and the digital certificate of the SmartModule becomes invalid, after enabling the function, press the RST button for 3s to 10s to enable the SmartModule to enter the mode of ignoring digital certificate expiration and restore the communication with the SmartLogger. The alarm/maintenance indicator (ALM) blinks red slowly. After the digital certificate of the SmartModule is reloaded through the SmartLogger, the SmartModule communication can recover.
	Hold down the button for more than 60s.	Within 3 minutes after the SmartModule is powered on after power-off, hold down the RST button for more than 60s to restart the SmartModule and restore factory settings.

Dimensions

Figure 2-13 Dimensions

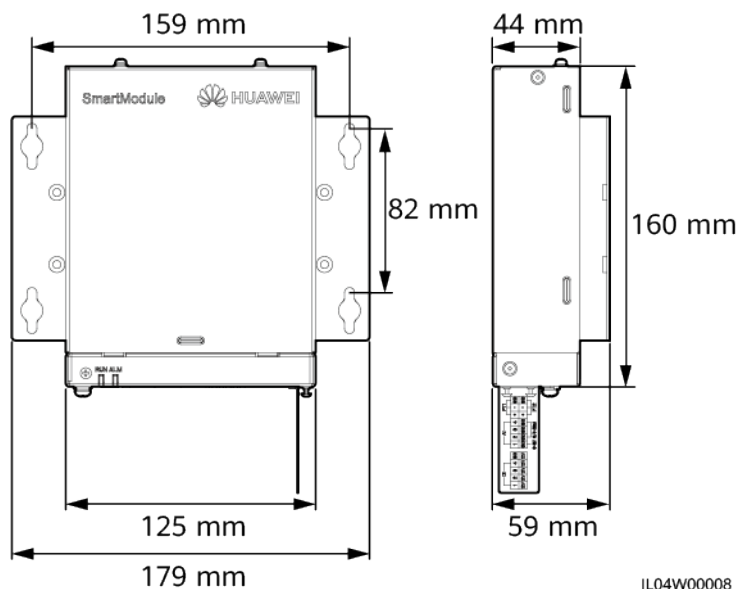









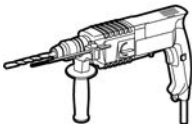
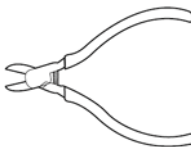
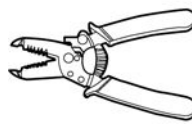
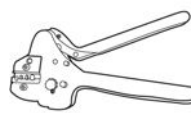
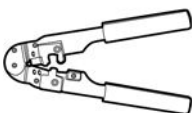

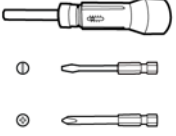



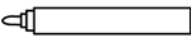

3 Device Installation

3.1 Checking Before Installation

Check Item	Criteria
Outer packaging	The outer package is intact. If it is damaged or abnormal, do not unpack it and contact your dealer.
Deliverables	Check the quantity of deliverables against the <i>Packing List</i> in the packing case. If any component is missing or damaged, contact your dealer.

3.2 Tools

Type	Tool			
Installation				
	Hammer drill	Diagonal pliers	Wire stripper	Crimping tool
				
	RJ45 crimping tool	Flat-head screwdriver	Torque screwdriver	Rubber mallet

Type	Tool			
	 Utility knife	 Cable cutter	 Vacuum cleaner	 Marker
	 Measuring tape	 Cable tie	 Heat gun	 Multimeter
	 Heat shrink tubing	 Bubble or digital level	-	-
PPE	 Safety gloves	 Safety goggles	 Anti-dust respirator	 Safety shoes

3.3 Installation Requirements

NOTICE

- Do not install the SmartLogger in areas with flammable and explosive materials and direct sunlight.
- The SmartLogger should be installed at a proper height to facilitate operation and maintenance.

Figure 3-1 Installation position

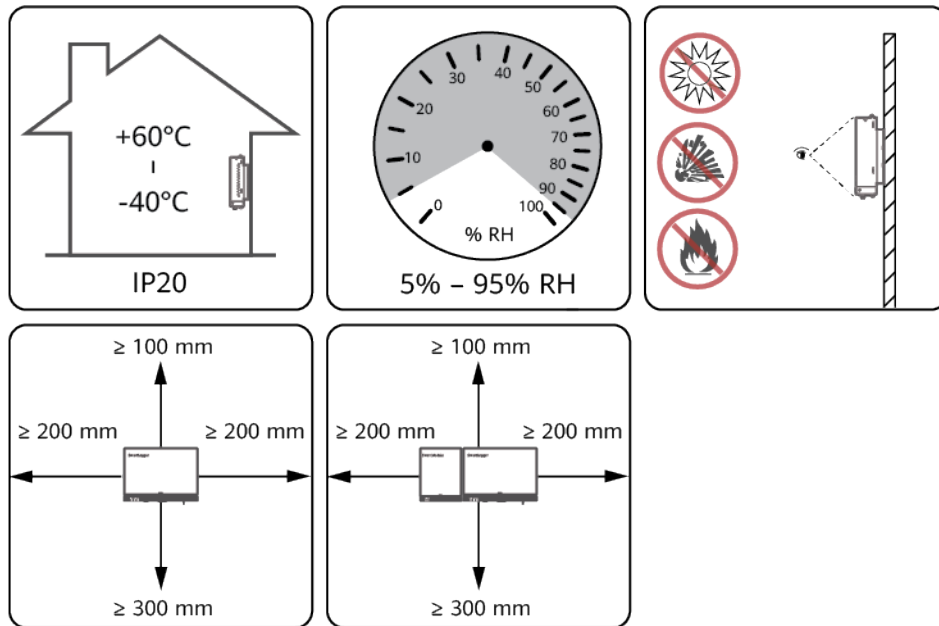

IL04Y00001

3.4 Installing the SmartLogger

The SmartLogger can be wall-mounted or guide rail-mounted.

Wall-mounted installation

WARNING

- Avoid drilling holes into the water pipes and power cables buried in the wall.
 - Install a SmartLogger on a flat and secure interior wall.
 - When wall-mounting the SmartLogger, ensure that the cable connection area faces downwards for ease of cable connection and maintenance.
 - You are advised to use the tapping screws and expansion tubes delivered with the SmartLogger.
-

Figure 3-2 Wall-mounted installation

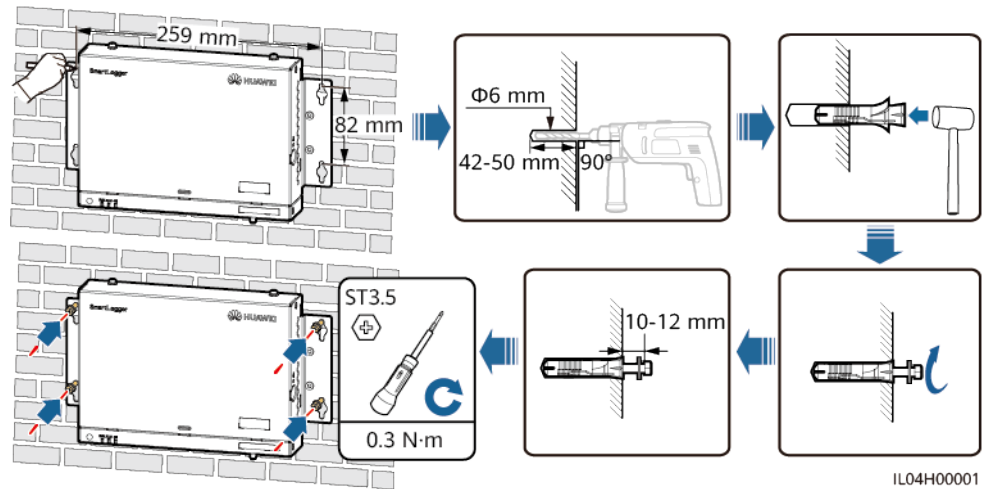

Guide Rail-mounted Installation

Prepare a 35 mm standard guide rail by yourself. Ensure that the guide rail:

- Has sufficient length for securing the SmartLogger. The recommended effective length is 230 mm or greater.
- Has been secured before you install the SmartLogger.

Figure 3-3 Guide rail-mounted installation

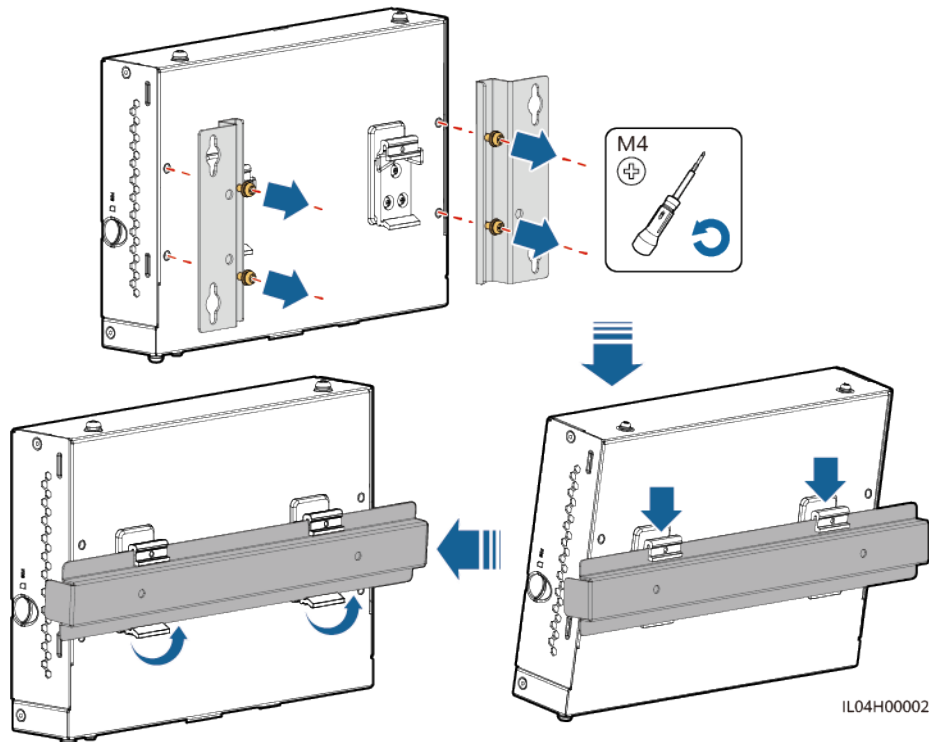

3.5 Installing the SmartLogger and SmartModule

Combine the SmartLogger and SmartModule and install them on a wall or along a guide rail.

Wall-mounted Installation

WARNING

Avoid drilling holes into the water pipes and power cables buried in the wall.

Step 1 Combine the SmartLogger and SmartModule.

NOTE

If the SmartLogger and SmartModule have been combined before delivery, skip this step.

Figure 3-4 Connecting the SmartLogger to the SmartModule using a connecting plate

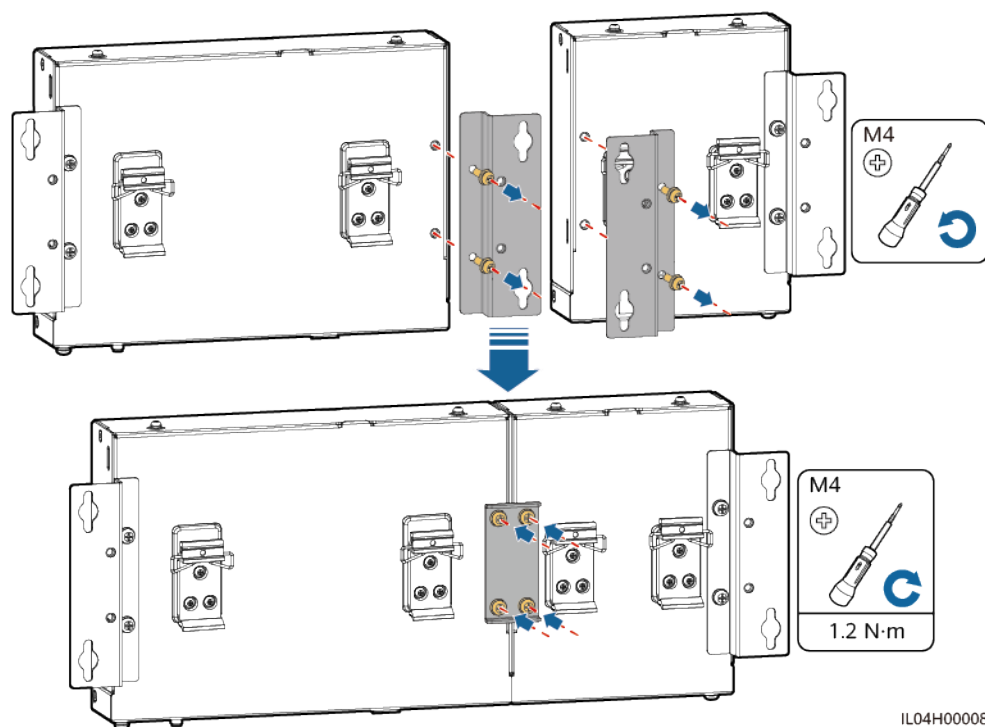

Step 2 Install the SmartLogger and SmartModule.

Figure 3-5 Wall-mounted installation

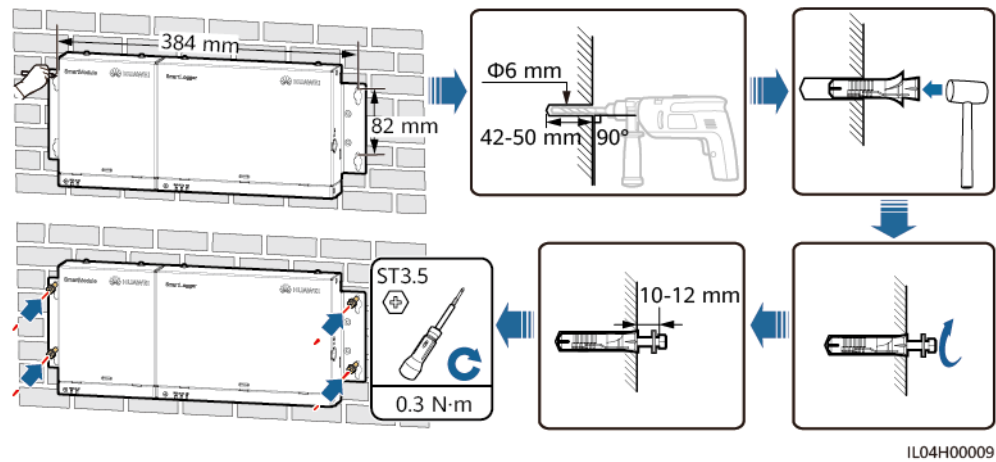

----End

Guide Rail-mounted Installation (Stand-alone)

Prepare a 35 mm standard guide rail by yourself. Ensure that the guide rail:

- Has sufficient length for securing the SmartLogger and SmartModule. The recommended effective length is 360 mm or greater.
- Has been secured before you install the SmartLogger and SmartModule.

NOTE

Ensure that the SIM card slot on the SmartLogger is not blocked.

Figure 3-6 Guide rail-mounted installation

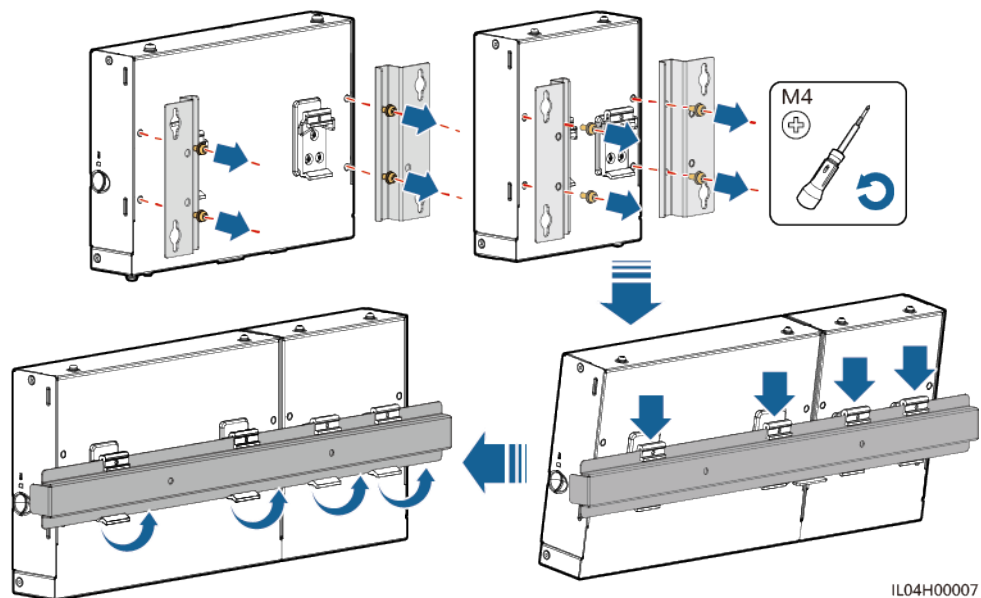

Guide Rail-mounted Installation (Combined)

Prepare a 35 mm standard guide rail by yourself. Ensure that the guide rail:

- Has sufficient length for securing the SmartLogger and SmartModule. The recommended effective length is 360 mm or greater.
- Has been secured before you install the SmartLogger and SmartModule.

 **NOTE**

Ensure that the SIM card slot on the SmartLogger is not blocked.

Step 1 Combine the SmartLogger and SmartModule.

 **NOTE**

If the SmartLogger and SmartModule have been combined before delivery, you only need to remove the mounting ears and guide rail clamps in the middle. You do not need to use a connecting plate to connect the SmartLogger and SmartModule.

Figure 3-7 Connecting the SmartLogger to the SmartModule using a connecting plate

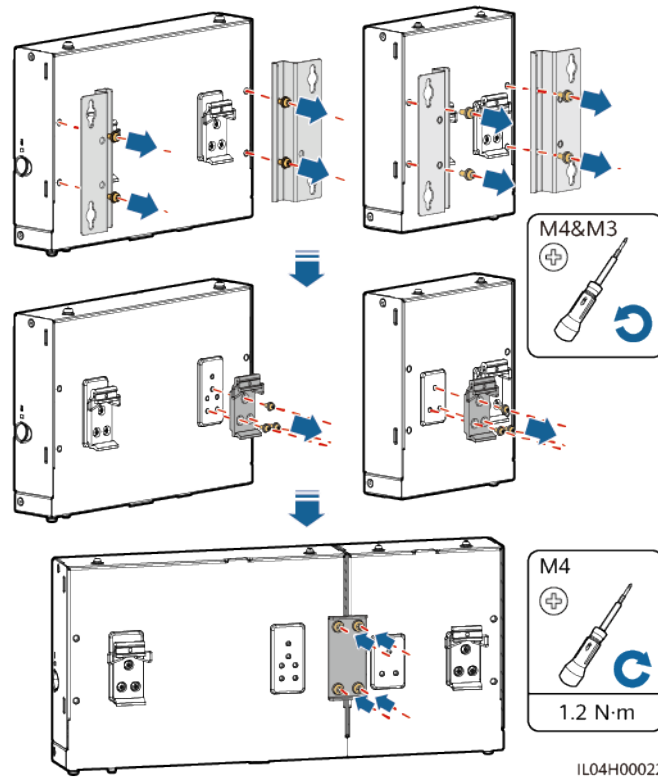

Step 2 Install the SmartLogger and SmartModule.

Figure 3-8 Guide Rail-mounted Installation

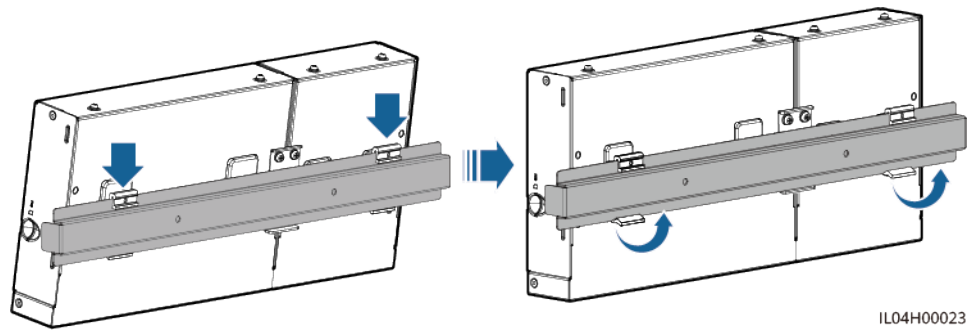

----End

3.6 Installing a Power Adapter

A power adapter can be installed on a wall or flat surface.

If the SmartLogger requires a power adapter for power supply, install a power adapter.

Wall-mounted installation

It is recommended that the power adapter be installed on the right side of the SmartLogger. Keep the AC power cable port upward.

⚠ WARNING

Avoid drilling holes into the water pipes and power cables buried in the wall.

Figure 3-9 Wall-mounted Installation (Mode 1)

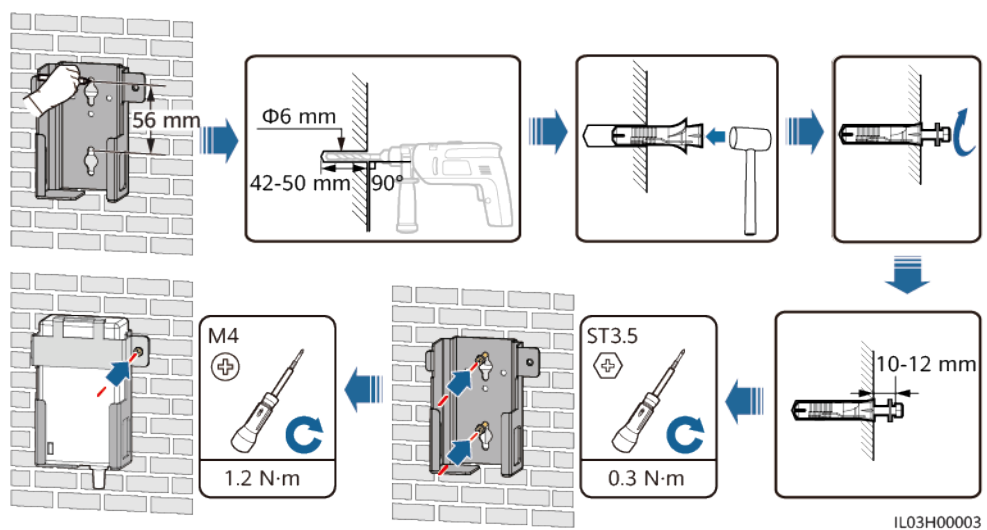
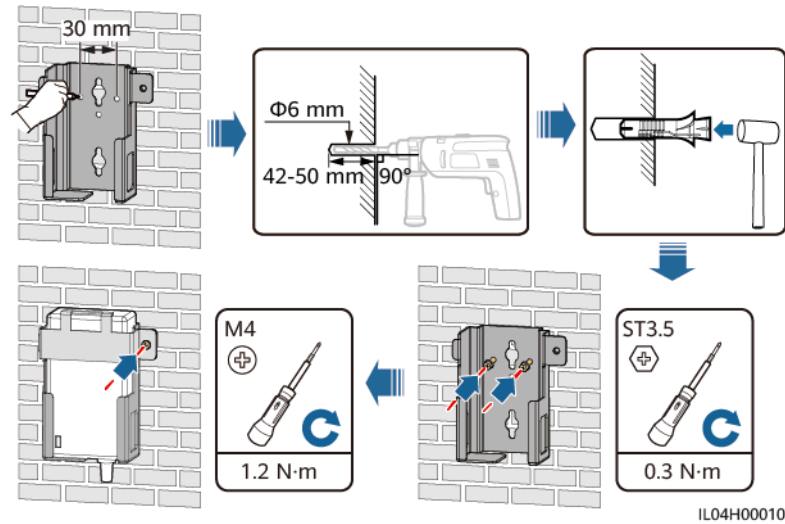

Figure 3-10 Wall-mounted Installation (Mode 2)



Flat Surface-mounted Installation

Install the power adapter on a flat surface. This section describes how to install the power adapter on the top of the SmartLogger.

Step 1 Place the power adapter horizontally on the top of the SmartLogger.

NOTICE

- Ensure that the power adapter indicator faces upward or outward.
- Ensure that the adapter is securely installed.

Step 2 Plan the cable route of the power adapter to ensure that the SIM card can be installed properly.

Figure 3-11 Flat surface-mounted installation

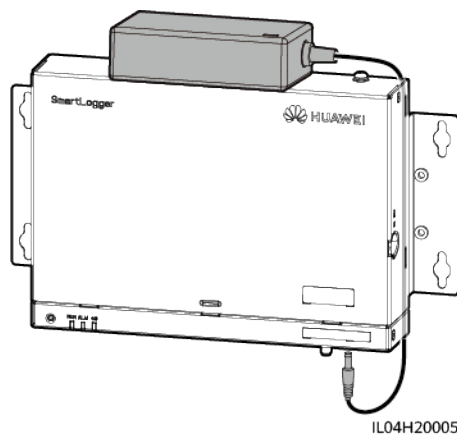

----End

4 Cable Connections

4.1 Connecting Cables to the SmartLogger

4.1.1 Preparing Cables

Type	Recommended Cable Specifications
PE cable	Outdoor copper-core cable with a cross-sectional area of 4–6 mm ² or 12–10 AWG
RS485 communications cable	Two-core or multiple-core cable with a cross-sectional area of 0.2–2.5 mm ² or 24–14 AWG
(Optional) MBUS cable	Delivered with the SmartLogger, 1.5 m long
DI signal cable	Two-core or multiple-core cable with a cross-sectional area of 0.2–1.5 mm ² or 24–16 AWG
Output power cable	
AI signal cable	
DO signal cable	
Network cable	Delivered with the SmartLogger, 2.2 m long. If the delivered network cable is too short, you are advised to prepare a network cable of Cat 5e or higher specifications and shielded RJ45 connectors.
(Optional) 24 V input power cable	Two-core cable with a cross-sectional area of 0.2–1.5 mm ² or 24–16 AWG

4.1.2 Connecting a PE Cable

Procedure

Step 1 Connect a PE cable.

Figure 4-1 Connecting a PE cable

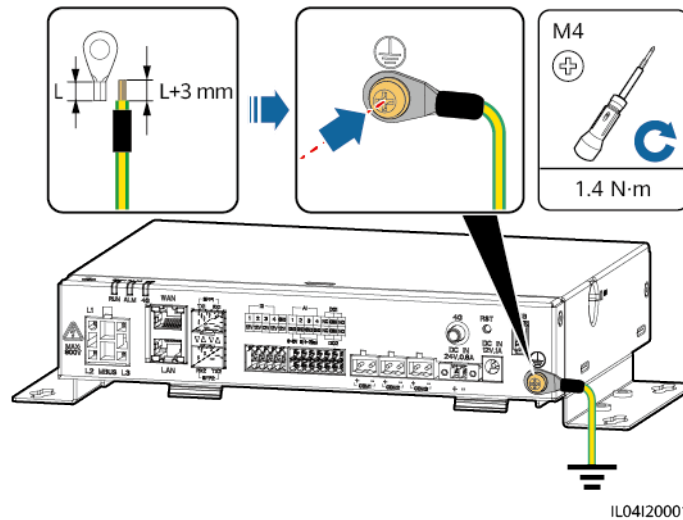

----End

4.1.3 Connecting an RS485 Communications Cable

Context

- The SmartLogger can connect to RS485 communications devices, such as a solar inverter, an environmental monitoring instrument (EMI), a power meter, and a PID over the COM port.
- Ensure that RS485+ is connected to COM+ of the SmartLogger and RS485- is connected to the COM- of the SmartLogger.

Procedure

Step 1 Connect an RS485 communications cable.

Figure 4-2 Connecting an RS485 communications cable

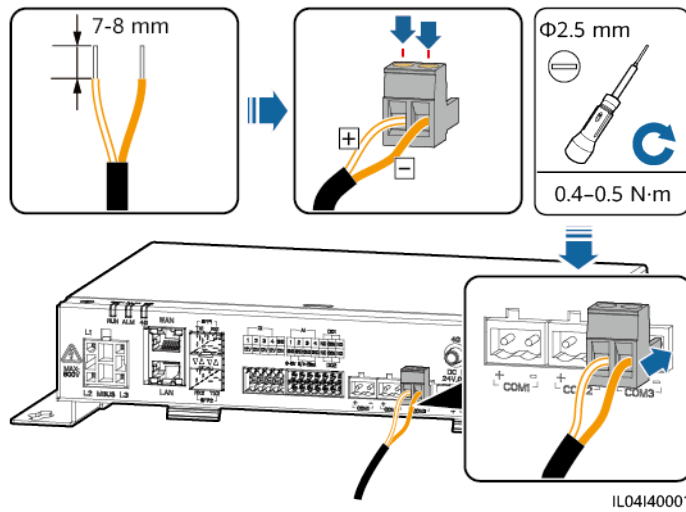

Port	Silk Screen	Description
COM1, COM2, and COM3	+	RS485A, RS485 differential signal+
	-	RS485B, RS485 differential signal-

Step 2 If devices need to be cascaded, cascade the devices and then connect them to the SmartLogger.

NOTICE

- You are advised to connect fewer than 30 devices to each RS485 route.
- The baud rate, communications protocol, and parity mode of all devices on an RS485 cascading link must be the same as those of the COM port on the SmartLogger.

Figure 4-3 Cascading connection

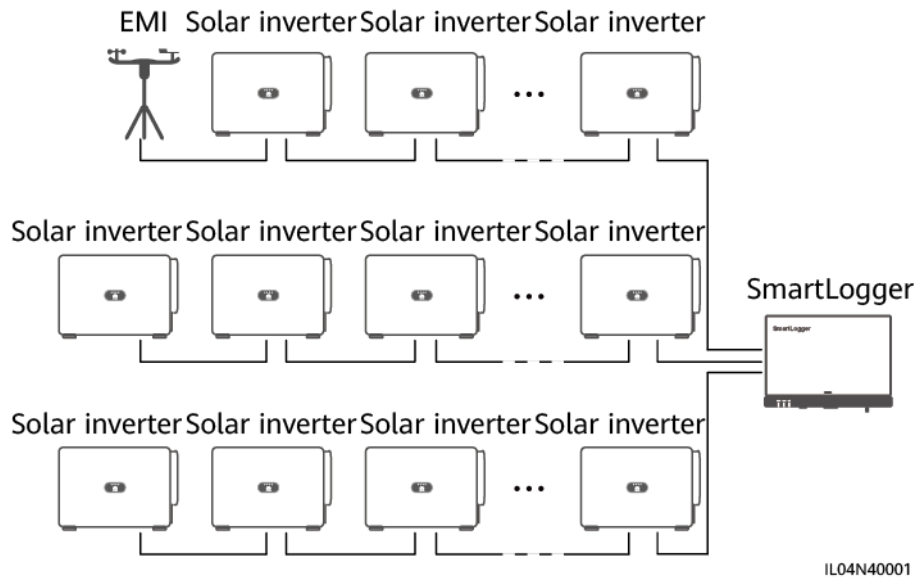

----End

4.1.4 Connecting an MBUS Cable

Context

If both the SmartLogger and the solar inverter support MBUS, the SmartLogger can be connected to the solar inverter through an AC power cable. In this case, you do not need to connect the RS485 communications cable to the solar inverter.

If the SmartLogger uses an AC power cable as the communications cable, an MCB and a knife fuse switch need to be installed to prevent device damage in the case of short circuits.

NOTICE

The rated power of the PV system connected to the MBUS port on the SmartLogger must be greater than 75 kW.

Figure 4-4 MBUS networking

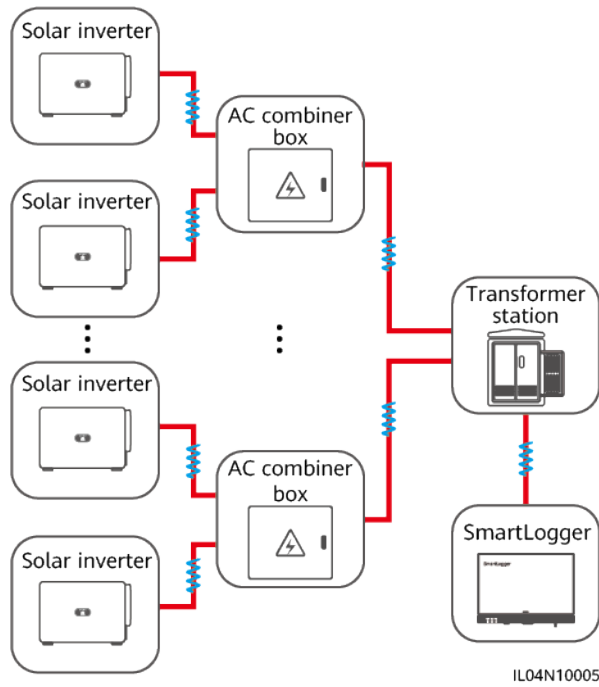

Procedure

Step 1 Connect an MBUS cable.

Figure 4-5 Connecting an MBUS Cable

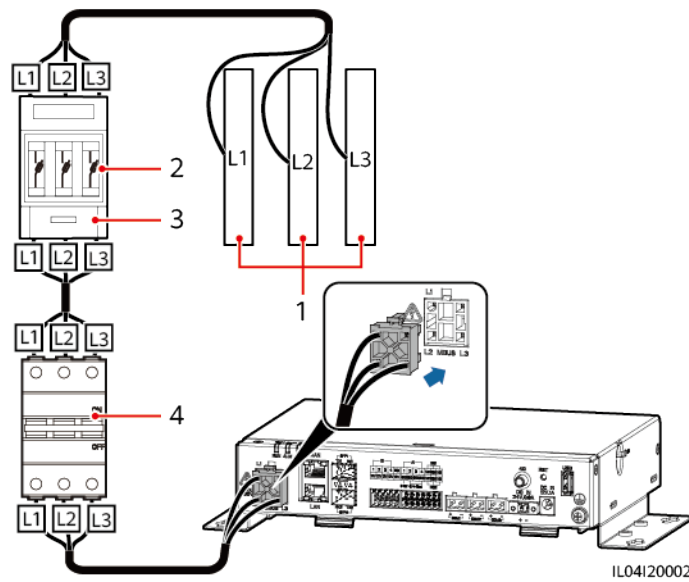

Table 4-1 Components

No.	Component	Specifications	Quantity
1	Busbar L1/L2/L3	N/A	1

No.	Component	Specifications	Quantity
2	Fuse	<ul style="list-style-type: none"> • When the rated AC voltage on the low-voltage side of the box-type transformer is less than or equal to 500 V, the rated voltage should be greater than or equal to 500 V; when the rated AC voltage on the low-voltage side of the box-type transformer is greater than 500 V and less than or equal to 800 V, the rated voltage should be greater than or equal to 800 V • When the rated AC voltage on the low-voltage side of the box-type transformer is less than or equal to 500 V, the rated current should be greater than or equal to 6 A; when the rated AC voltage on the low-voltage side of the box-type transformer is greater than 500 V and less than or equal to 800 V, the rated current should be greater than or equal to 32 A 	3
3	Knife fuse switch box	<ul style="list-style-type: none"> • When the rated AC voltage on the low-voltage side of the box-type transformer is less than or equal to 500 V, the rated voltage should be greater than or equal to 500 V; when the rated AC voltage on the low-voltage side of the box-type transformer is greater than 500 V and less than or equal to 800 V, the rated voltage should be greater than or equal to 800 V • When the rated AC voltage on the low-voltage side of the box-type transformer is less than or equal to 500 V, the rated current should be greater than or equal to 6 A; when the rated AC voltage on the low-voltage side of the box-type transformer is greater than 500 V and less than or equal to 800 V, the rated current should be greater than or equal to 32 A; number of poles: 3 	1

No.	Component	Specifications	Quantity
4	MCB	<ul style="list-style-type: none"> • When the rated AC voltage on the low-voltage side of the box-type transformer is less than or equal to 500 V, the rated voltage should be greater than or equal to 500 V; when the rated AC voltage on the low-voltage side of the box-type transformer is greater than 500 V and less than or equal to 800 V, the rated voltage should be greater than or equal to 800 V • When the rated AC voltage on the low-voltage side of the box-type transformer is less than or equal to 500 V, the rated current is greater than or equal to 6 A and less than or equal to 32 A; when the rated AC voltage on the low-voltage side of the box-type transformer is greater than 500 V and less than or equal to 800 V, the rated current is 32 A 	1

----End

4.1.5 Connecting a DI Signal Cable

Context

The SmartLogger can receive DI signals such as remote power grid scheduling commands and alarms over DI ports. It can only receive passive dry contact signals. It is recommended that the signal transmission distance be less than or equal to 10 m.

Procedure

Step 1 Connect a DI signal cable.

Figure 4-6 Connecting a DI signal cable

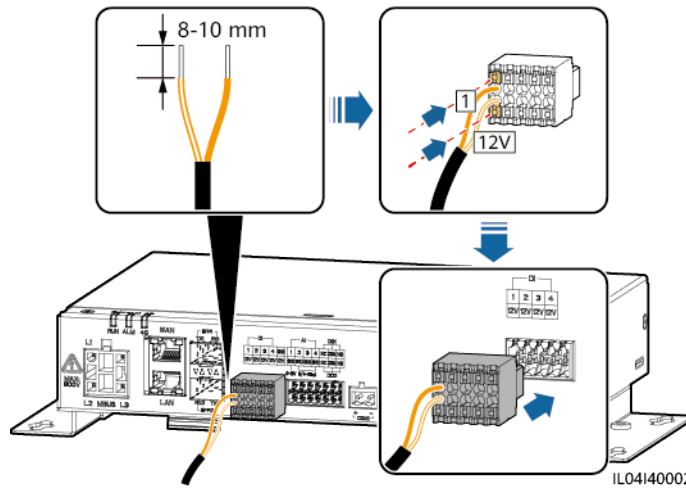

Port		Silk Screen	Description
DI	DI1	1	Can connect to four passive dry contact signals.
		12V	
	DI2	2	
		12V	
	DI3	3	
		12V	
	DI4	4	
		12V	

----End

4.1.6 Connecting the Output Power Cable

Context

In the export limitation or audible and visual alarm scenario, the SmartLogger can drive the coil of the intermediate relay through the 12 V output power port. It is recommended that the transmission distance be less than or equal to 10 m.

Procedure

Step 1 Connect the output power cable.

Figure 4-7 Connecting the output power cable

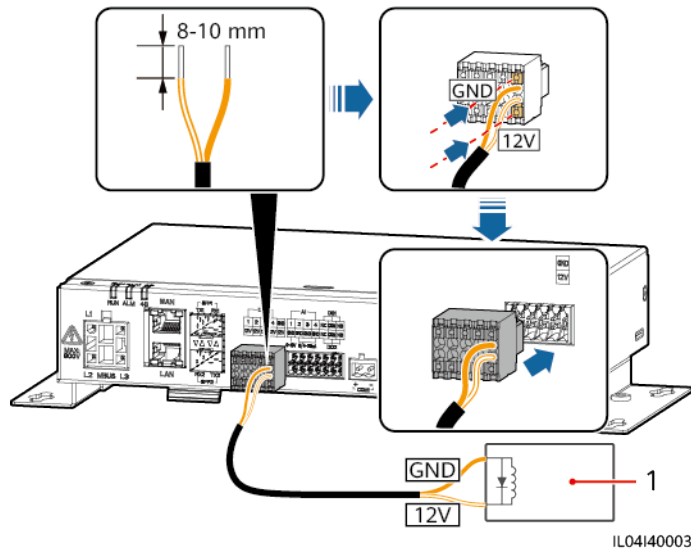

(1) Intermediate relay

----End

4.1.7 Connecting the AI Signal Cable

Context

The SmartLogger can receive AI signals from EMIs over AI ports. It is recommended that the signal transmission distance be less than or equal to 10 m.

Procedure

Step 1 Connect the AI signal cable.

Figure 4-8 Connecting the AI signal cable

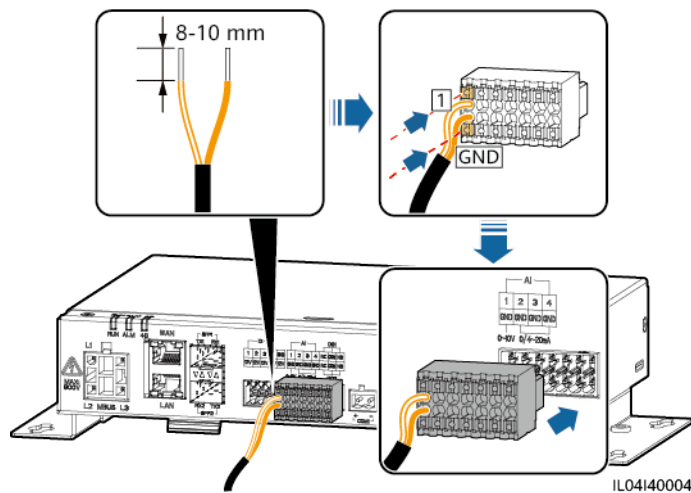

Port		Silk Screen	Description
AI	AI1	1	Supports 0–10 V input voltage.
		GND	
	AI2	2	Support 0–20 mA or 4–20 mA input current.
		GND	
	AI3	3	
		GND	
	AI4	4	
		GND	

 NOTE

AI ports 1, 2, 3, and 4 are for AI+ signals, and the GND port is for AI- signals.

----End

4.1.8 Connecting the DO Signal Cable

Context

The DO port supports a maximum of 12 V signal voltage. The NC/COM is a normally closed contact, while the NO/COM is a normally open contact. It is recommended that the signal transmission distance be less than or equal to 10 m.

Procedure

Step 1 Connect the DO signal cable.

Figure 4-9 Connecting a DO Signal Cable

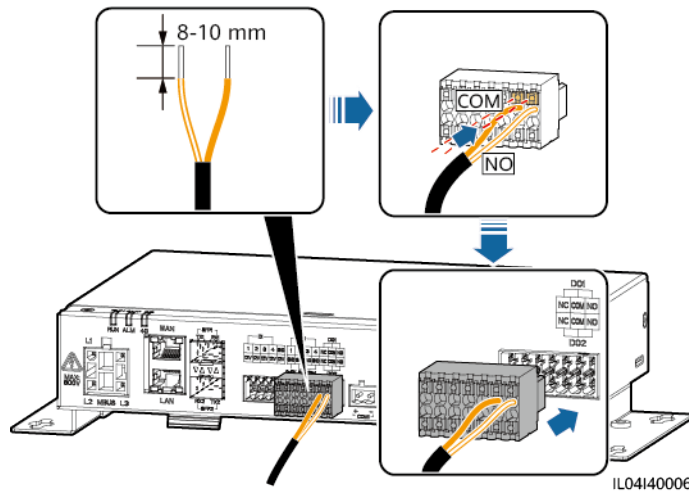

----End

4.1.9 Connecting the Ethernet Cable

Context

- The SmartLogger can connect to an Ethernet switch, router, or PC over a WAN port.
- The SmartLogger can be connected to the SmartModule or a PC over the LAN port.

Procedure

Step 1 Connect the Ethernet cable.

NOTE

When crimping the network cable, ensure that the shielding layer of the cable is securely connected to the metal shell of the RJ45 connectors.

Figure 4-10 Connecting an Ethernet cable

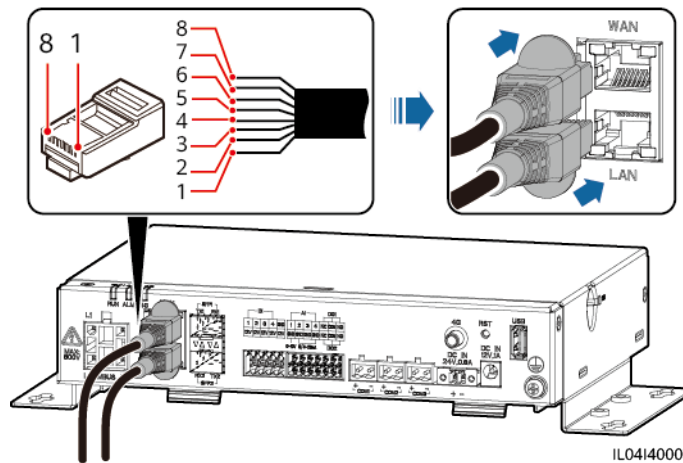

- | | | | |
|----------------------|------------|---------------------|-----------|
| (1) White-and-orange | (2) Orange | (3) White-and-green | (4) Blue |
| (5) White-and-blue | (6) Green | (7) White-and-brown | (8) Brown |

----End

4.1.10 Connecting Fiber Jumpers

Context

The SmartLogger can connect to devices such as the access terminal box through optical fibers.

Procedure

- Step 1** Insert an optical module into the SFP1 or SFP2 port of the SmartLogger. If there are two modules, insert one into each port.

NOTICE

- Optical modules are optional. Configure the 100M or 1000M optical module based on the peer port of the optical switch. The optical module should use the SFP or eSFP encapsulation. The transmission distance supported by the 100M optical module should be greater than or equal to 12 km, and the transmission distance supported by the 1000M optical module should be greater than or equal to 10 km.
- When inserting an optical module into the SFP1 port, verify that the side with a label faces upward. When inserting an optical module into the SFP2 port, verify that the side with a label faces downward.

- Step 2** Connect the fiber jumpers delivered with the optical module to the ports of the optical module.

Figure 4-11 Connecting fiber jumpers

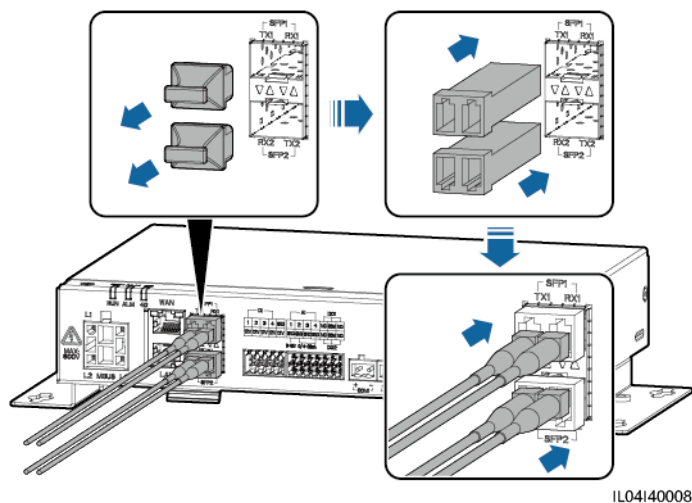

IL04140008

----End

Follow-up Procedure

Disconnection can be performed in reverse order.

NOTE

- When removing an optical fiber, press the latch first.
- When removing an optical module, pull it out by the handle. Ensure that the interval between removing and inserting an optical module is greater than 0.2s.

4.1.11 Installing a SIM Card and a 4G Antenna

Context

The SmartLogger provides the 4G wireless communication function. A SIM card of the local carrier can be inserted for dial-up access.

Prepare a standard SIM card (dimensions: 25 mm x 15 mm; capacity ≥ 64 KB). Monthly traffic of the SIM card \geq Monthly traffic of the solar inverter + Monthly traffic of the power meter + Monthly traffic of the EMI. If other devices are connected to the SmartLogger in the network, the monthly traffic of the SIM card needs to be increased as required.

Table 4-2 SIM card traffic description

Access NMS type	Monthly Traffic Requirement of the SIM Card		Traffic Baseline
	FusionSolar Smart PV Manage	Solar inverter	
	Power meter	3 MB x Number of power meters	

Access NMS type	Monthly Traffic Requirement of the SIM Card		Traffic Baseline
ment System	EMI	3 MB x Number of EMIs	<ul style="list-style-type: none"> The solar inverter logs and I-V curve diagnosis data can be exported monthly. The solar inverters can be upgraded monthly.
Poverty alleviation monitoring center	Solar inverter	15MB×Number of solar inverters	N/A

Procedure

Step 1 Insert a SIM card into the SIM card slot.

NOTICE

- When installing the SIM card, determine its installation direction based on the silk screen.
- Press the SIM card in place to lock it. In this case, the SIM card is correctly installed.
- When removing the SIM card, push it inward to eject it.

Step 2 Install an antenna.

Figure 4-12 Installing the SIM card and antenna

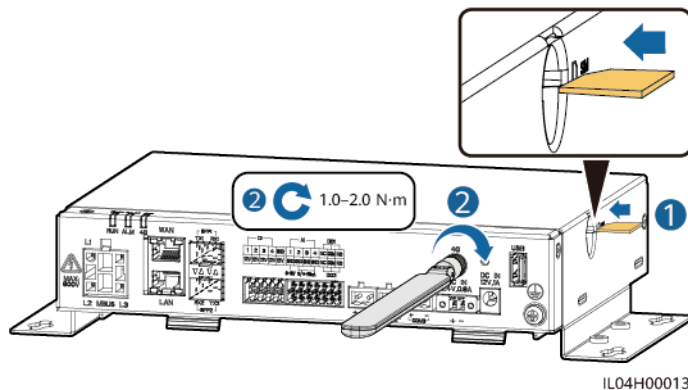

IL04H00013

----End

4.1.12 Connecting the 24 V Input Power Cable

Context

The 24 V input power cable needs to be connected in the following scenarios:

- Scenario 1: The 24 V DC power supply is used.
- Scenario 2: The SmartLogger connects to the power supply through the 12 V input power port, and the 24 V input power port functions as the 12 V output power port to supply power to devices.

Procedure

Step 1 Connect the input power cable.

Figure 4-13 Connecting the input power cable

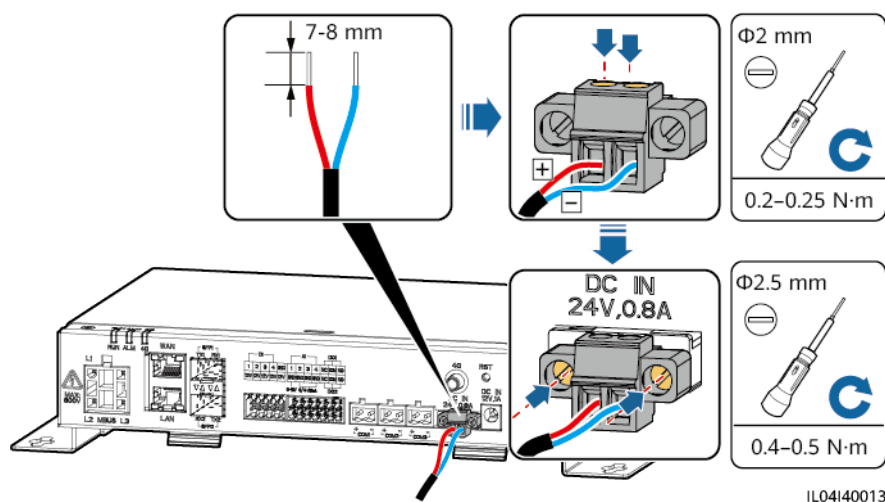

----End

4.2 Connecting Cables to the SmartModule

4.2.1 Preparing Cables

Type	Recommended Cable Specifications
PE cable	Outdoor copper-core cable with a cross-sectional area of 4–6 mm ² or 12–10 AWG
Network cable	The cable is delivered with the SmartModule and is 0.35 m long. If the delivered network cable is too short, you are advised to prepare a network cable of Cat 5e or higher specifications and shielded RJ45 connectors.
12 V power input cable	The cable is delivered with the SmartModule and is 0.5 m long.

Type	Recommended Cable Specifications
RS485 communications cable	Two-core or multiple-core cable with a cross-sectional area of 0.2–2.5 mm ² or 24–14 AWG
DI signal cable	Two-core or multiple-core cable with a cross-sectional area of 0.2–1.5 mm ² or 24–16 AWG
Output power cable	
AI signal cable	
PT signal cable	For details about the cables and cable connection operations, see the documents delivered with the PT100/PT1000.
(Optional) 24 V power input cable	Two-core cable with a cross-sectional area of 0.2–1.5 mm ² or 24–16 AWG

4.2.2 Connecting the PE Cable

Procedure

Step 1 Connect the PE cable.

Figure 4-14 Connecting a PE cable

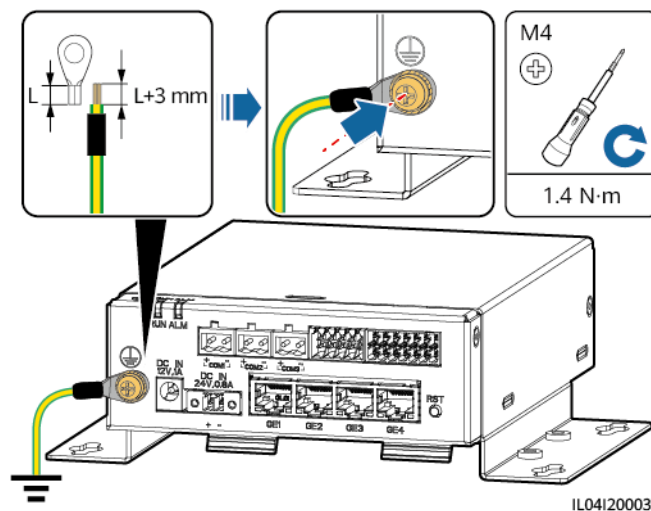

NOTE

If the SmartLogger is connected to the SmartModule over a connecting plate, connect a PE cable to the ground point of the SmartLogger or SmartModule based on site requirements.

----End

4.2.3 Connecting the Ethernet Cable

Context

The SmartModule can be connected to the SmartLogger and a PC over the GE port.

Connect the LAN port of the SmartLogger to one GE port of the SmartModule using an Ethernet cable. The SmartModule obtains an IP address from the DHCP server and automatically registers with the SmartLogger.

Procedure

Step 1 Connect the Ethernet cable.

 **NOTE**

When crimping the network cable, ensure that the shielding layer of the cable is securely connected to the metal shell of the RJ45 connectors.

Figure 4-15 Connecting an Ethernet Cable

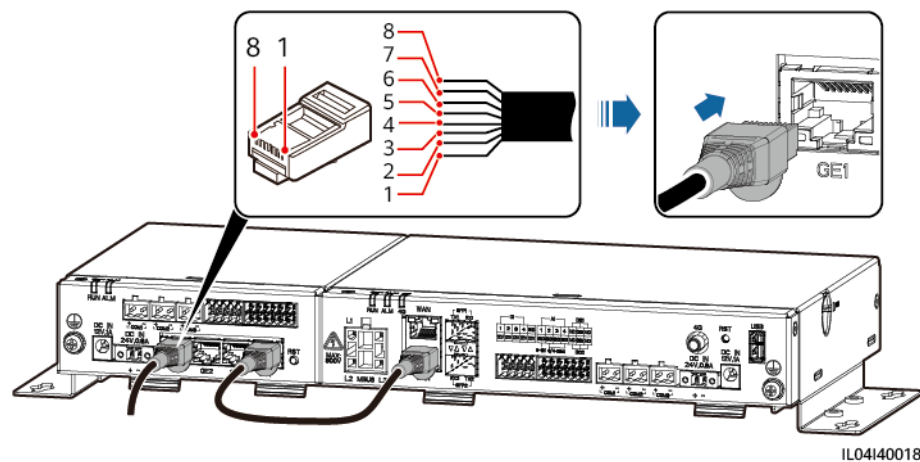

- | | | | |
|----------------------|------------|---------------------|-----------|
| (1) White-and-orange | (2) Orange | (3) White-and-green | (4) Blue |
| (5) White-and-blue | (6) Green | (7) White-and-brown | (8) Brown |

----End

4.2.4 Connecting the 12 V Power Input Cable

Context

The SmartLogger connects to the power supply through the 12 V power input port, and the 24 V power input port of the SmartLogger functions as the 12 V power output port to supply power to the SmartModule.

Procedure

Step 1 Connect the 12 V power input cable.

Figure 4-16 Connecting the 12 V power input cable

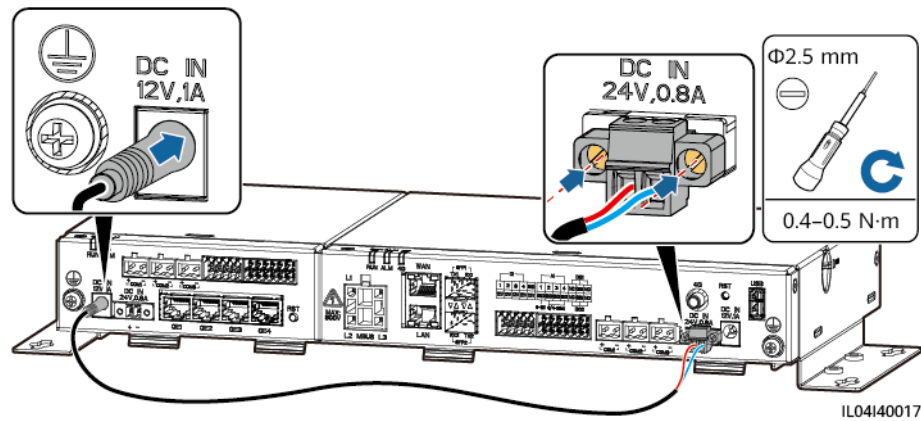

----End

4.2.5 Connecting the RS485 Communications Cable

Context

- The SmartModule can connect to RS485 communications devices, such as a solar inverter, an EMI, a power meter, and a PID over COM ports.
- Ensure that RS485+ is connected to COM+ of the SmartModule and RS485- is connected to the COM- of the SmartModule.

Procedure

Step 1 Connect the RS485 communications cable.

Figure 4-17 Connecting an RS485 communications cable

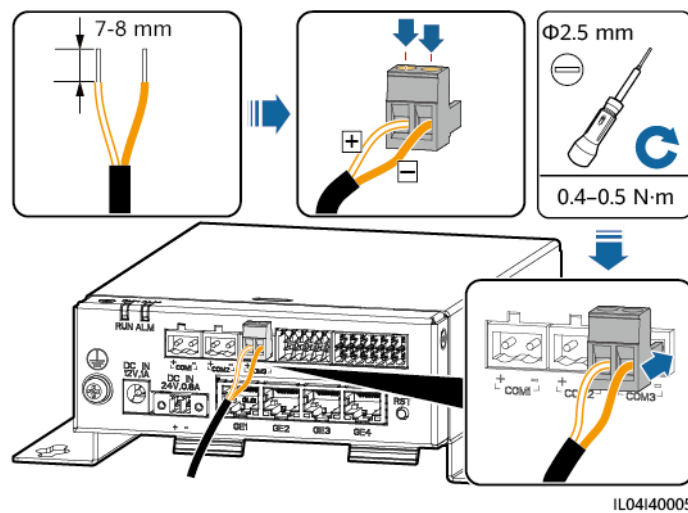

Port	Silk Screen	Description
COM1, COM2, and COM3	+	RS485A, RS485 differential signal+

Port	Silk Screen	Description
	-	RS485B, RS485 differential signal-

Step 2 If devices need to be cascaded, cascade the devices and then connect them to the SmartModule.

NOTICE

- You are advised to connect fewer than 30 devices to each RS485 route.
- The baud rate, communications protocol, and parity mode of all devices on an RS485 cascading link must be the same as those of the COM port of the SmartModule.

Figure 4-18 Cascading connection

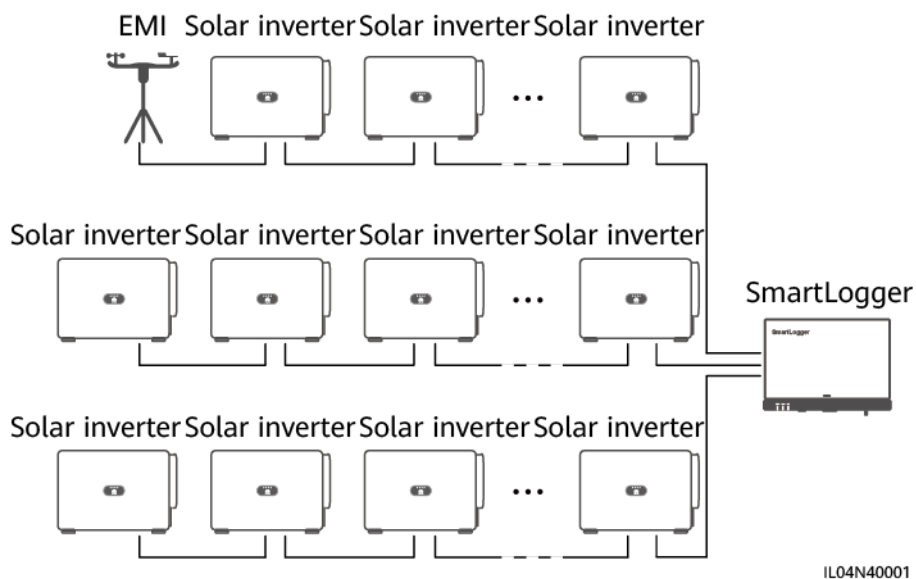

----End

4.2.6 Connecting the DI Signal Cable

Context

The SmartModule can receive DI signals such as remote commands and alarms over DI ports. It can only receive passive dry contact signals. It is recommended that the signal transmission distance be less than or equal to 10 m.

Procedure

Step 1 Connect the DI signal cable.

Figure 4-19 Connecting the DI signal cable

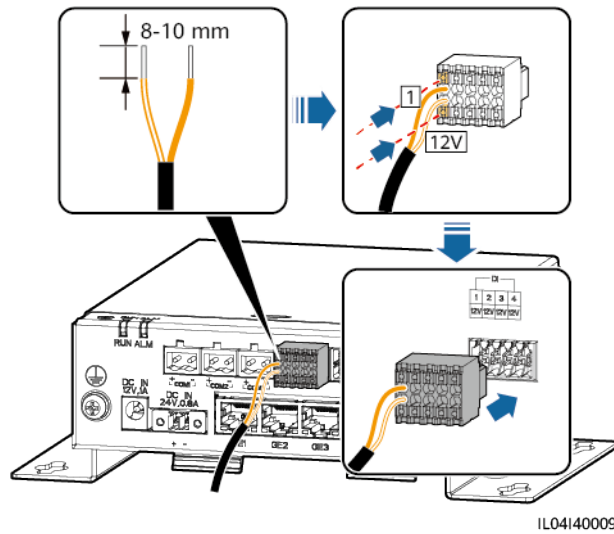

Port		Silk Screen	Description
DI	DI1	1	Can connect to four passive dry contact signals.
		12V	
	DI2	2	
		12V	
	DI3	3	
		12V	
	DI4	4	
		12V	

----End

4.2.7 Connecting the Output Power Cable

Context

In the export limitation or audible and visual alarm scenario, the SmartModule can drive the coil of the intermediate relay through the 12 V power output port. It is recommended that the transmission distance be less than or equal to 10 m.

Procedure

Step 1 Connect the power output cable.

Figure 4-20 Connecting the power output cable

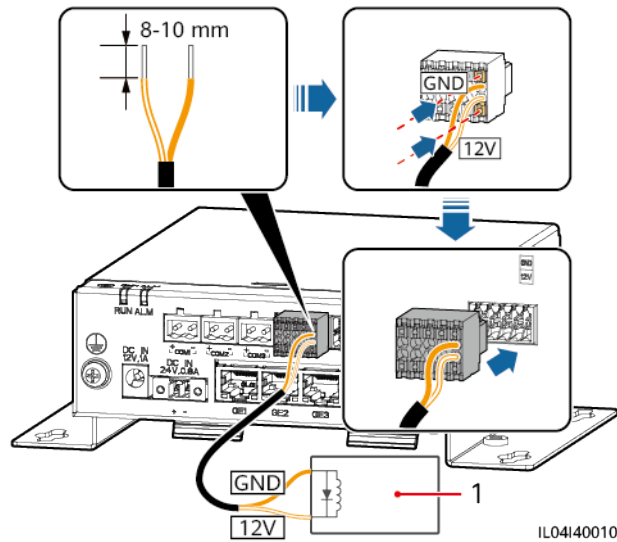

(1) Intermediate relay

----End

4.2.8 Connecting the AI Signal Cable

Context

The SmartModule can receive AI signals from EMIs over AI ports. It is recommended that the signal transmission distance be less than or equal to 10 m.

Procedure

Step 1 Connect the AI signal cable.

Figure 4-21 Connecting the AI signal cable

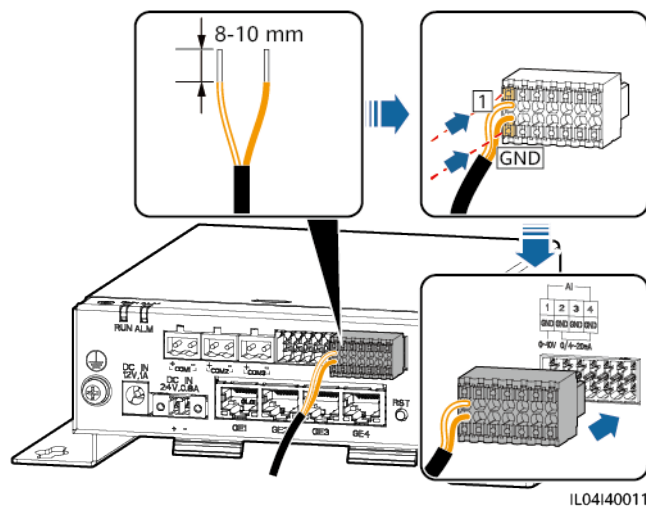

Port		Silk Screen	Description
AI	AI1	1	Supports 0–10 V input voltage.
		GND	
	AI2	2	Support 0–20 mA or 4–20 mA input current.
		GND	
	AI3	3	
		GND	
	AI4	4	
		GND	

 NOTE

AI ports 1, 2, 3, and 4 are for AI+ signals, and the GND port is for AI- signals.

----End

4.2.9 Connecting the PT Signal Cable

Context

The SmartModule provides two PT ports, which can be used to connect to three-wire or two-wire PT100/PT1000 temperature sensors.

When a PT port needs to be connected to a two-wire PT100/PT1000, use a short-circuit cable to short-circuit **GND** and – of the port.

Procedure

Step 1 Connect the PT signal cable.

Figure 4-22 Connection to a three-wire PT100/PT1000

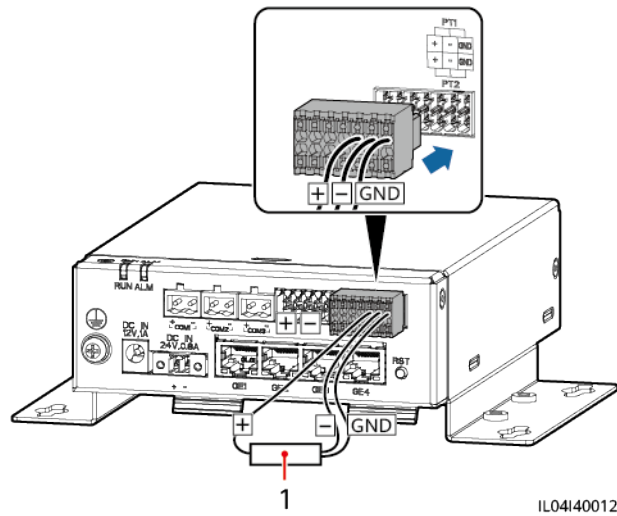

(1) PT100/PT1000 temperature sensor

Figure 4-23 Connection to a two-wire PT100/PT1000

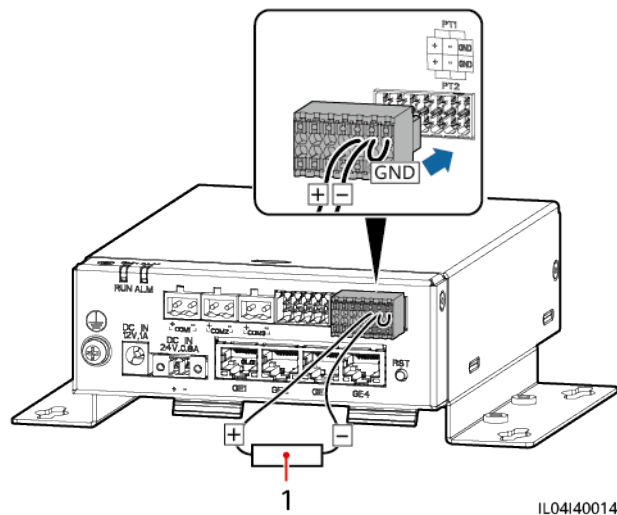

(1) PT100/PT1000 temperature sensor

----End

4.2.10 Connecting the 24 V Power Input Cable

Context

The 24 V power input cable needs to be connected in the following scenarios:

- Scenario 1: The 24 V DC power supply is used.
- Scenario 2: The SmartModule connects to the power supply through the 12 V power input port, and the 24 V power input cable functions as the 12 V power output port to supply power to a device.

Procedure

Step 1 Connect the power input cable.

Figure 4-24 Connecting the power input cable

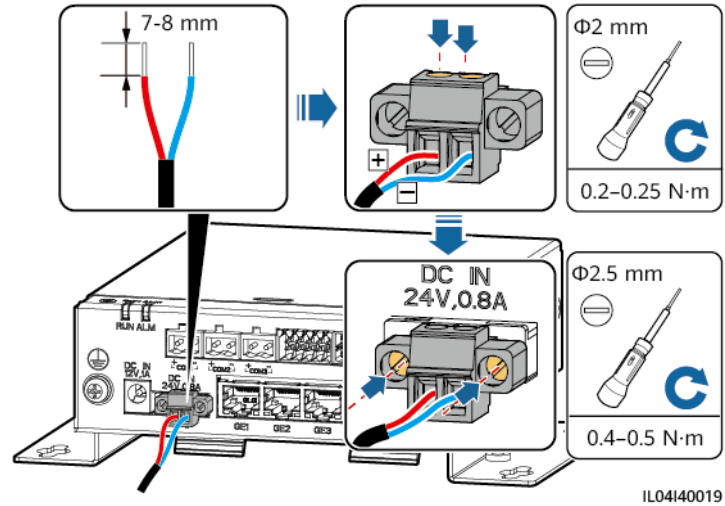

----End

5 System Operation

5.1 Check Before Power-on

No.	Check That
1	The SmartLogger and SmartModule are installed correctly and securely.
2	All cables are connected securely.
3	Routing for the power cables and signal cables meets the requirements for routing strong-current and weak-current cables and complies with the cable routing plan.
4	Cables are bound neatly, and cable ties are secured evenly and properly in the same direction.
5	There are no sundries such as unnecessary adhesive tape or cable ties on cables.

5.2 Powering On the System

Step 1 Connect the power supply.

- **Method 1:** When a power adapter is used, connect the power adapter cable and turn on the switch on the AC socket side.

 **NOTE**

- The rated input voltage of the power adapter is 100–240 V AC, and the rated input frequency is 50/60 Hz.
- Select an AC socket that matches the power adapter.

Figure 5-1 Power supply through the power adapter

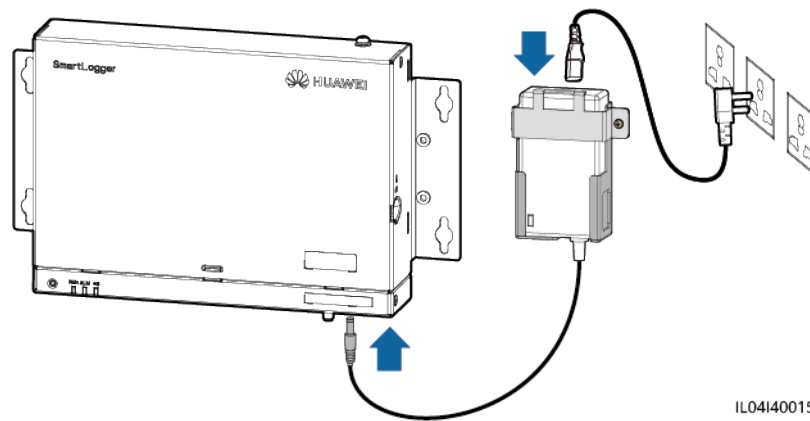

- **Method 2:** When a DC power supply is used, check that the cable between the DC power supply and the SmartLogger as well as the SmartModule is connected properly, and turn on the upstream power switch of the DC power supply.

Step 2 When MBUS is used for communication, turn on all the upstream switches of the MBUS port.

----End

6 WebUI Operations

6.1 Introduction to WebUI

NOTICE

- The web software version corresponding to the WebUI screenshots in this document is SmartLogger V300R001C00SPC030. The screenshots are for reference only.
 - The parameter names, value ranges, and default values are subject to change. The actual display prevails.
 - Delivering a reset, shutdown, or upgrade command to the solar inverters may cause power grid connection failure, which affects the energy yield.
 - Only professionals are allowed to set the grid parameters, protection parameters, feature parameters, and power adjustment parameters of the solar inverters. If the grid parameters, protection parameters and feature parameters are incorrectly set, the solar inverters may not connect to the power grid. If the power adjustment parameters are incorrectly set, the solar inverters may not connect to the power grid as required. In these cases, the energy yield will be affected.
 - Only professionals are allowed to set the power grid scheduling parameters of the SmartLogger. Incorrect settings may cause the PV plant to fail to connect to the power grid as required, which affects the energy yield.
-

6.1.1 WebUI Layout



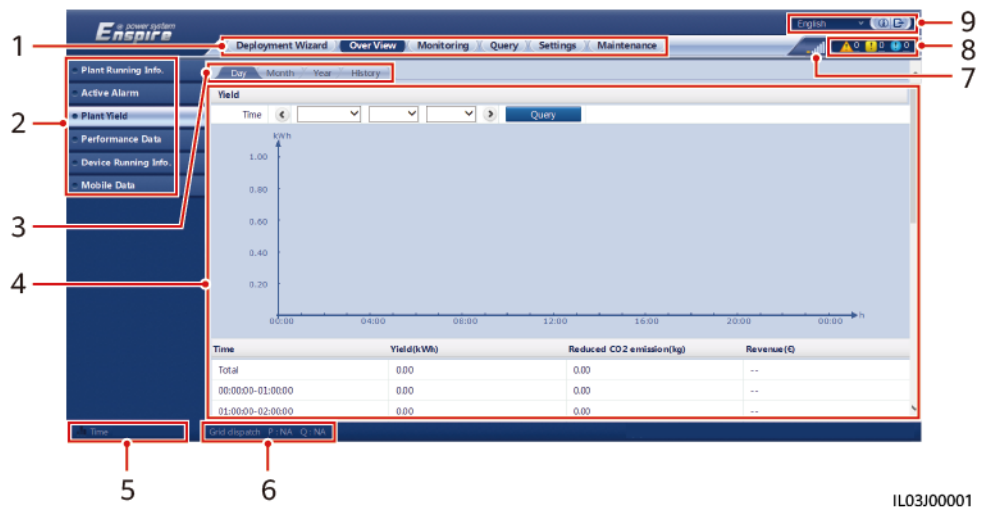











Figure 6-1 WebUI layout





IL03J00001

No.	Function	Description
1	First-level menu	Choose the corresponding first-level menu before you perform any operation over the WebUI.
2	Second-level menu	Under the first-level menu, choose the device to be queried or the parameter to be set under the second-level menu.
3	Third-level menu	<ul style="list-style-type: none"> After choosing a second-level menu, choose a third-level menu to access the query or setting page. There are no third-level menus under certain second-level menus.
4	Details page	Displays details of the queried information or parameter setting.
5	System time	Displays the current system time.
6	Power grid scheduling	Displays the current power grid scheduling mode of the system.
7	Icon for SIM card signal strength	Displays the signal strength of the SIM card.
8	Alarm icon	Displays the severities and number of active system alarms. You can click a number to access the alarm page.
9	Display language	Selects the display language or chooses to log out.

6.1.2 Icon Description

Icon	Description	Icon	Description
	Click the About icon to query the WebUI version information.		Click the Drop-down icon to select a parameter or time.
	Click the Exit icon to log out.		Alarms are classified into major, minor, and warning ones. Click the Alarm icon to query an alarm.
	Click the Increase/Decrease icon to adjust time.		Click the Start icon to start the device.
	The Select icon indicates that a parameter is selected.		Click the Stop icon to shut down the device.
	The Select icon indicates that a parameter is not selected. Click the icon to select a parameter.		Click the Reset icon to reset the device.
	Hide icon and Display icon.		<ul style="list-style-type: none"> The solar inverter is in On-grid state. The device such as the EMI, power meter, slave SmartLogger, or MBUS is in Online state. The PID is in Running state.
	The device is in Disconnection state. If a device is in Disconnection state, its parameters cannot be set.		The solar inverter is in Loading state.

Icon	Description	Icon	Description
	<ul style="list-style-type: none"> The solar inverter is in Initializing, Power-off, Idle, or other state in which it is not feeding power into the grid. The PID device is in Power-off, Idle or other state in which it is not running properly. 		Ascending order or descending order icon. Click the icon to sort the items in ascending or descending order for the corresponding column.

6.1.3 WebUI Menus

Table 6-1 WebUI menus

Main Menu	Second-Level Menu	Third-Level Menu	Function
Deployment Wizard	N/A	N/A	Supports the deployment wizard function. You can set deployment parameters, connect devices, and connect to the management system according to the wizard.
Over View	Plant Running Info.	N/A	Queries PV plant information.
	Active Alarm	N/A	Queries active alarms.
	Plant Yield	N/A	Queries the energy yield of the system. <ul style="list-style-type: none"> Daily energy yield: The data can be stored for 30 days on an hourly basis. Monthly energy yield: The data can be stored for one year on a daily basis. Annual energy yield: The data can be stored for 10 years on a monthly basis. Historical energy yield: The data can be stored for 25 years on a yearly basis.
	Performance Data	N/A	Queries or exports performance data.

Main Menu	Second-Level Menu	Third-Level Menu	Function
	Device Running Info.	N/A	Queries or exports device running information.
	Mobile Data	N/A	Queries mobile network data.
Monitoring	SmartLogger3000	Running Info.	Queries the running information.
		Active Alarm	Queries active alarms.
		About	Queries the version and communication information of the master SmartLogger.
	SmartLogger	About	Queries the version and communication information of the slave SmartLogger.
	SUN2000	Running Info.	Queries the running information.
		Active Alarm	Queries active alarms.
		Performance Data	Queries or exports performance data.
		Yield	Queries the energy yield.
		Running Param.	Sets running parameters.
		Tracking System	Sets tracking system parameters.
		Characteristic Curve	Sets the characteristic curve.
		About	Queries the version and communication information.
	MBUS	Running Info.	Queries the running information.
		STA List	<ul style="list-style-type: none"> • Sets or synchronizes the baud rates of MBUS communication devices. • Exports the STA list.
		Networking Settings	<ul style="list-style-type: none"> • Sets running parameters. • Manages the SN list.
		About	Queries the version and communication information.
	EMI	Running Info.	Queries the running information.
		Performance Data	Queries or exports performance data.
		Running Param.	Sets running parameters.

Main Menu	Second-Level Menu	Third-Level Menu	Function
		About	Queries communication information.
	Power Meter	Running Info.	Queries the running information.
		Performance Data	Queries or exports performance data.
		Running Param.	Sets the running parameters of the DL/T645 power meter.
		About	Queries communication information.
	PID	Running Info.	Queries the running information.
		Active Alarm	Queries active alarms.
		Performance Data	Queries or exports performance data.
		Running Param.	Sets running parameters.
		About	Queries the version and communication information.
	STS	Teleindication	Queries teleindication parameters.
		Telemetry	Queries telemetry parameters.
		Telecontrol	Sets telecontrol parameters.
		Performance Data	Queries or exports performance data.
		Running Param.	Sets running parameters.
		About	Queries communication information.
	Custom Device, IEC103 Device, and IEC104 Device	Running Info.	Queries the running information.
		Teleindication	Queries teleindication parameters.
		Telemetry	Queries telemetry parameters.
		Telecontrol	Sets telecontrol parameters.
		Teleadjust	Sets teleadjust parameters.
Query	Alarm History	N/A	Queries historical alarms.
	Operation Log	N/A	Queries operation logs.
	Export Data	N/A	Exports historical alarms, energy yield, operation logs, and power grid scheduling data.
Settings	User Param.	Date&Time	Sets the date and time.

Main Menu	Second-Level Menu	Third-Level Menu	Function
		Plant	Sets PV plant information.
		Revenue	Sets the revenue parameters.
		Save Period	Sets the save period of performance data.
	Comm. Param.	Wireless Network	<ul style="list-style-type: none"> • Sets parameters for the built-in WLAN. • Sets mobile data (4G/3G/2G) parameters.
		Wired Network	Sets wired network parameters.
		RS485	Sets RS485 parameters.
		Power Meter	Sets power meter parameters.
		Management System	<ul style="list-style-type: none"> • Sets management system parameters. • Uploads a security certificate.
		Modbus TCP	Sets Modbus TCP parameters.
		IEC103	Sets IEC103 parameters.
		IEC104	Sets IEC104 parameters.
		FTP	Sets FTP parameters.
		Email	Sets email parameters.
		Power Adjustment	Active Power Control
	Reactive Power Control		Sets parameters for reactive power control.
	Export Limitation		Provides a wizard for export limitation. You can set parameters by following the wizard.
	Smart Reactive Power Compensation		Provides a wizard for smart reactive power compensation. You can set parameters by following the wizard.
	DRM		Sets DRM parameters.
	Remote Shutdown	Dry Contact Remote Shutdown	Sets parameters for remote shutdown over dry contacts.
	DI	N/A	Configures the DI port function.

Main Menu	Second-Level Menu	Third-Level Menu	Function	
	Alarm Output	N/A	Sets the mapping between solar inverter alarms and DO ports.	
	Smart Tracking Algorithm	N/A	Sets the parameters related to the smart tracking algorithm.	
	Other Parameters	N/A	<ul style="list-style-type: none"> Enables or disables RS485 upgrade rate adaptation. Enables or disables data forwarding for unconnected devices. Sets the IEC104 data push period. Enables or disables AI1 SPD alarm detection. Enables or disables STS overtemperature protection. Sets the reset control port of the external router. 	
Maintenance	Firmware Upgrade	N/A	Upgrades the firmware of the SmartLogger, solar inverter, MBUS, or PID.	
	Product Information	N/A	Queries product information.	
	Security Settings	N/A	<ul style="list-style-type: none"> Changes the user password. Sets the automatic logout time. Uploads a network security certificate. Updates the key. Sets web TLS1.0. Sets digital signature verification. 	
	System Maint.	N/A	<ul style="list-style-type: none"> Resets the system. Restores factory settings. Clears data. Exports all configuration files. Imports all configuration files. 	
	Device Log	N/A	Exports device logs.	
	Onsite Test	Inspection		Starts the health check of solar inverters.
		Spot-check		Starts the spot-check of solar inverters.

Main Menu	Second-Level Menu	Third-Level Menu	Function
	License Management	N/A	<ul style="list-style-type: none">Views the license information.Exports the license application file.Loads or revokes a license.
	Device Mgmt.	Connect Device	<ul style="list-style-type: none">Adds or removes a device.Imports or exports configurations.
		SmartModule	<ul style="list-style-type: none">Removes the SmartModule.Sets the authentication password.
		Device List	<ul style="list-style-type: none">Modifies device information.Imports or exports device information.
		Export Param.	Exports device parameters.
		Clear Alarm	Clears device alarms.
		Data Re-collection	Recollects historical performance data and energy yield of devices.
		Adjust total energy yield	Adjusts the total energy yield.

 **NOTE**

The third-level menu varies with the device model and grid code. The displayed menu prevails.

6.2 Device Commissioning

Prerequisites

- Device and cable installation has been checked according to PV plant specifications and requirements.
- The PV plant devices and SmartLogger are powered on.
- You have obtained the IP address of the SmartLogger as well as the user name and password used for logging in to the WebUI.

Context

After installing or replacing a device or SmartLogger, you need to set device parameters and add the device.

6.2.1 Preparations and WebUI Login

Prerequisites

- The operating system of Windows 7 or later is supported.
- Browser: Chrome 52, Firefox 58, or Internet Explorer 9, or a later version is recommended.

Procedure

Step 1 Connect the network cable between the network port of the PC and the WAN or LAN port of the SmartLogger.

Step 2 Set the IP address for the PC on the same network segment as the SmartLogger IP address.

Connected Port	Item	SmartLogger Default Value	Example PC Setting
LAN port	IP address	192.168.8.10	192.168.8.11
	Subnet mask	255.255.255.0	255.255.255.0
	Default gateway	192.168.8.1	192.168.8.1
WAN port	IP address	192.168.0.10	192.168.0.11
	Subnet mask	255.255.255.0	255.255.255.0
	Default gateway	192.168.0.1	192.168.0.1

NOTE

- If the IP address of the WAN port is on the 192.168.8.1–192.168.8.255 network segment, the IP address of the LAN port is automatically switched to 192.168.3.10, and the default gateway is 192.168.3.1. If the connection port is a LAN port, the network configuration of the PC needs to be adjusted accordingly.
- It is recommended that the PC be connected to the LAN port of the SmartLogger or the GE port of the SmartModule. When the PC is connected to the GE port of the SmartModule, adjust the network configuration of the PC to the configuration mode when the PC is connected to the LAN port of the SmartLogger.

Step 3 Set LAN parameters.

NOTICE

- If the SmartLogger is connected to a local area network (LAN) and a proxy server has been set, you need to cancel the proxy server settings.
- If the SmartLogger is connected to the Internet and the PC is connected to the LAN, do not cancel the proxy server settings.

1. Open Internet Explorer.

2. Choose **Tools > Internet Options**.
3. Click the **Connections** tab and then click **LAN settings**.
4. Clear **Use a proxy server for your LAN**.

Figure 6-2 LAN settings

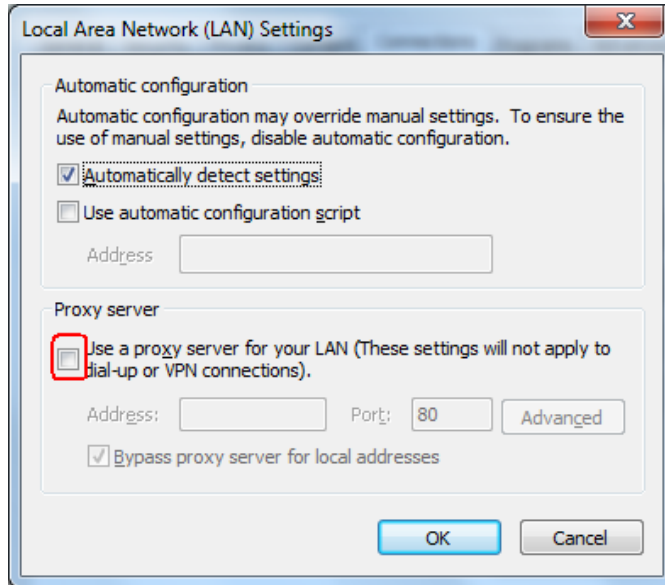

5. Click **OK**.

Step 4 Log in to the SmartLogger WebUI.

1. In the address box of a browser, enter `https://XX.XX.XX.XX` (XX.XX.XX.XX is the IP address of the SmartLogger) and press Enter. The login page is displayed. If you log in to the WebUI for the first time, a security risk warning is displayed. Click **Continue to this website** to log in to the WebUI.

NOTE

- It is recommended that users use their own certificates. If the certificate is not replaced, the security risk warning will be displayed during each login.
- After logging in to the WebUI, you can import a certificate under **Maintenance > Security Settings > Network Security Certificate**.
- The imported security certificate needs to be bound to the SmartLogger IP address. Otherwise, the security risk warning will still be displayed during login.

Figure 6-3 Security risk warning

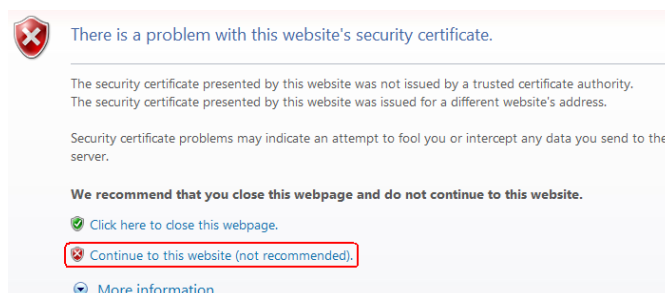

- Specify **Language**, **User Name**, and **Password**, and click **Log In**.

Figure 6-4 Login page

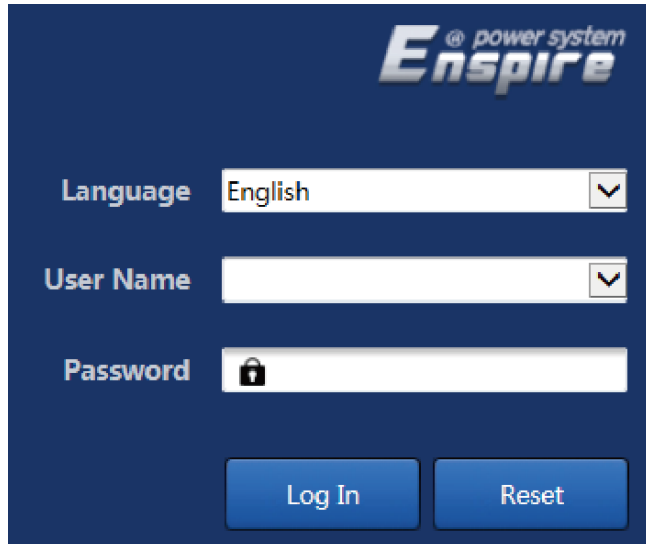

IL03J00002

Parameter	Description
Language	Set this parameter as required.
User Name	Select admin .
Password	<ul style="list-style-type: none"> - The initial password is Changeme. - Use the initial password upon first power-on and change it immediately after login. Then, use the new password to log in again. To ensure account security, change the password periodically and keep the new password in mind. A password left unchanged for a long period of time may be stolen or cracked. If a password is lost, the device needs to be restored to its factory settings. In these cases, the user is liable for any loss caused to the PV plant. - If you enter incorrect passwords for five consecutive times in 5 minutes, your account will be locked out. You have to try again 10 minutes later.

 **NOTE**

After logging in to the WebUI, a dialog box is displayed. You can view the recent login information. Click **OK**.

----End

Follow-up Procedure

If any page is blank or a menu cannot be accessed after you log in to the WebUI, clear the cache, refresh the page, or log in again.

6.2.2 Commissioning Using Deployment Wizard

Context

The SmartLogger supports the deployment wizard for setting basic SmartLogger parameters, connecting Huawei devices, power meters, and EMIs, configuring Huawei NMS, configuring third-party NMS, and interworking with third-party devices.

After the SmartModule communicates with the SmartLogger properly, the SmartLogger automatically identifies the SmartModule. The device name of the SmartModule is **Module(M1)**, and the corresponding port is **M1. port**.

Procedure

Step 1 Log in as user **admin** to access the deployment wizard page.

Step 2 Set parameters as prompted. For details, click **Help** on the page.

 **NOTE**

During parameter setting, click **Previous**, **Next**, or **Skip** as required.

Figure 6-5 Deployment wizard

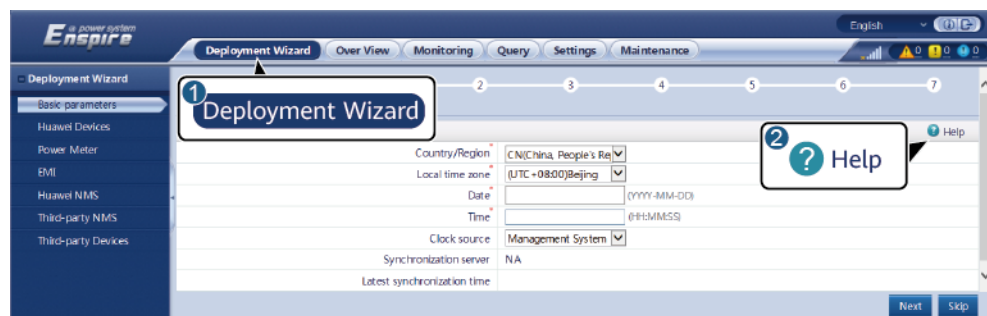

IL03J00003

Step 3 After setting parameters, click **Finish**.

----End

6.3 Parameter Settings

NOTICE

- If the parameters listed in this section have been set in **Deployment Wizard**, ignore the corresponding settings.
- If the PV plant does not contain certain devices, such as power meters, EMIs, IEC103 devices, custom devices, and IEC104 devices, ignore the corresponding settings.

6.3.1 Setting User Parameters

Set user parameters and click **Submit**.

Figure 6-6 Setting user parameters

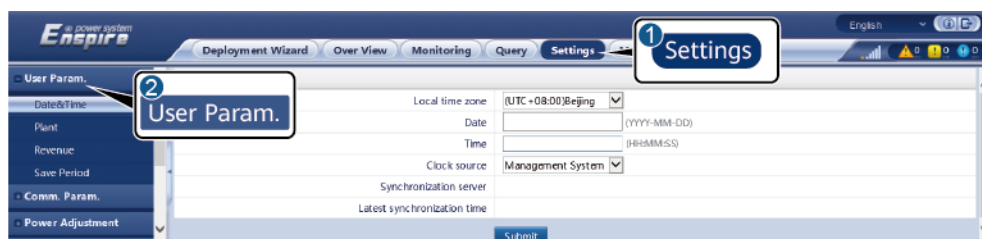

IL04J00001

Date&Time

Parameter	Description
Local time zone	Select a time zone based on the region where the PV plant is located.
DST enable	Set this parameter as required. NOTE This parameter is unavailable for zones without DST.
Date	Set this parameter to the local date.
Time	Set this parameter to the local time.
Clock source	Set this parameter as required. The value can be NTP , Management System , IEC104 , or Modbus TCP . If there is no management system, ignore the corresponding setting.

NOTICE

- After the date and time are set, the date and time of all the inverters connected to the SmartLogger are updated accordingly. Ensure that the settings are correct.
- Changing the date and time affects the recording of system energy yield and performance data. Do not change the time zone or system time unless necessary.

Plant

Parameter	Description
Plant name	NOTE In the English half-width status, you cannot enter any of the following characters: <>,'?()#&\\$ %+;~^"
Plant address	
Plant owner	
Plant owner address	
Country/Region	Select a country/region based on the region where the PV plant is located.

Revenue

Parameter	Description
Currency	Set this parameter as required. The value can be EUR, GBP, USD, CNY, or JPY .
Electricity price/kWh	Set this parameter to the local electricity price, which is used to calculate the converted revenue of the energy yield.
CO2 emission reduction coefficient	Set this parameter based on the local standard.

Save Period

Parameter	Description
Performance data save period	Set this parameter to the save period of performance data. After the setting, the data will be displayed accordingly on the performance data page.

6.3.2 Setting Parameters for Connecting to the Management System

Procedure

Step 1 Set up a network connection.

- **Method 1:** When the SmartLogger connects to the management system over the 4G/3G/2G network, set mobile data parameters and click **Submit**.

Figure 6-7 Setting mobile data parameters

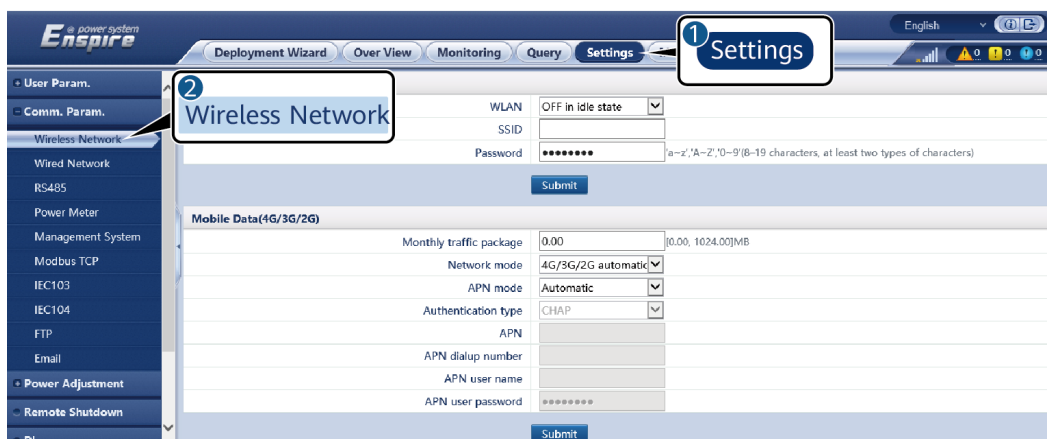

IL04J00002

Parameter	Description
Monthly traffic package	Set this parameter based on the SIM card traffic package.
Network mode	Set this parameter based on the SIM card network mode.
APN mode	The default value is Automatic . Set this parameter to Manual if the dial-up connection cannot be set up in Automatic mode.
Authentication type	When APN mode is set to Manual , you need to set the parameters related to the SIM card. Obtain the information about the parameters from the SIM card operator.
APN	
APN dialup number	
APN user name	
APN user password	

- **Method 2:** When the SmartLogger connects to the management system over a wired network, set the wired network parameters and click **Submit**.

Figure 6-8 Setting wired network parameters

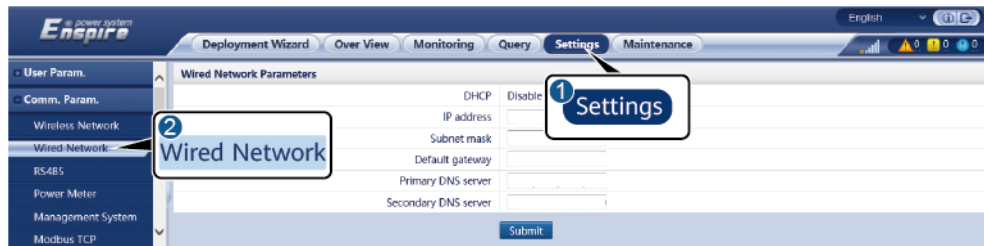

IL03J00006

Parameter	Description
DHCP	<ul style="list-style-type: none"> The WAN port of the SmartLogger supports IP address obtaining using DHCP and automatic registration. After the SmartModule is connected to the LAN port of the SmartLogger through the GE port, the SmartModule can obtain an IP address using DHCP and automatically register with the SmartLogger. <p>NOTE After the SmartLogger connects to the SUN2000 app or FusionSolar app, tap More > Settings > Comm. Param. > Ethernet to access the Ethernet parameter setting screen and set DHCP to Enable.</p>
IP Address	<p>Set this parameter based on the PV plant plan.</p> <p>NOTE If the IP address is changed, use the new IP address to log in again.</p>
Subnet mask	<p>Set this parameter based on the actual subnet mask of the LAN where the SmartLogger is located.</p>
Default gateway	<p>Set this parameter based on the actual gateway of the LAN where the SmartLogger is located.</p>
Primary DNS server	<p>You can ignore this parameter if the SmartLogger connects to the LAN.</p> <p>Set this parameter to the IP address of the LAN router when the SmartLogger connects to the public network (for example, connecting to the hosting cloud server, email server, or third-party FTP server).</p>
Secondary DNS server	<p>In normal cases, you can ignore this parameter.</p> <p>If the primary DNS server cannot resolve the domain name, the secondary DNS server is used.</p>

Step 2 Set management system parameters.

- Method 1:** When the SmartLogger connects to a Huawei or third-party management system using the encrypted Modbus TCP protocol, set management system parameters and click **Submit**.

 **NOTE**

After a Huawei NMS or a third-party NMS is connected to the SmartLogger in **Management System**, another third-party NMS can be connected through **Management System-1** to obtain data from the SmartLogger and configure the SmartLogger.

Figure 6-9 Setting management system parameters

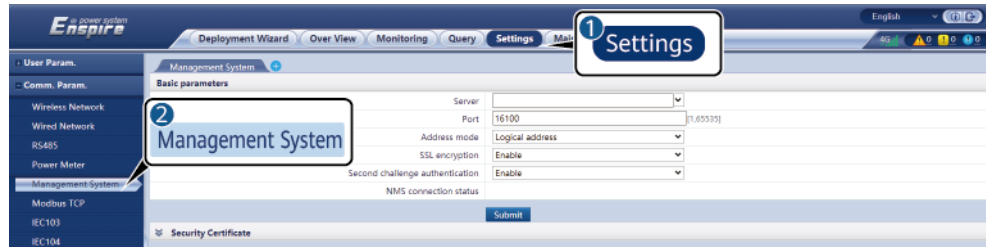

IL04J00003

Table 6-2 Management System

Parameter	Description
Server	Set this parameter to the IP address or domain name of the Management System .
Port	Set this parameter based on the connected Management System .
Address mode	The value can be Comm. Address or Logical address . If the communications address of the device connected to the SmartLogger is unique, you are advised to select Comm. Address . In other cases, you must select Logical address .
SSL encryption	Retain the default value Enable . NOTE If this parameter is set to Disable , data exchange between the SmartLogger and the management system will not be encrypted, which poses security risks.
Second challenge authentication	Set this parameter based on the connected management system. NOTE If this parameter is set to Disable , the second challenge authentication result is not checked, and user data may be stolen. Therefore, exercise caution when setting this parameter.
Security certificate	Optional. Set this parameter only when the certificate has expired or the customer needs to use their own certificate.

Figure 6-10 Setting management system-1 parameters

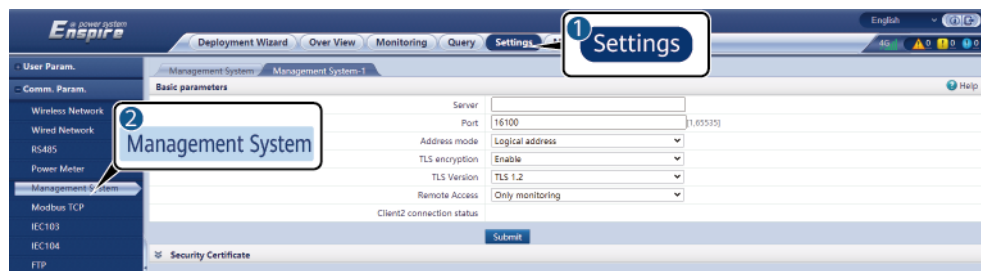

Table 6-3 Management System-1

Parameter	Description
Server	Set this parameter to the IP address or domain name of Management System-1 .
Port	Set this parameter based on the connected Management System-1 .
Address mode	Comm. Address and Logical address are supported. If the communication address of the device connected to the SmartLogger is unique, you are advised to select Comm. Address . Otherwise, you must select Logical address .
TLS encryption	Retain the default value Enable . NOTE If this parameter is set to Disable , data exchange between the SmartLogger and the management system will not be encrypted, which poses security risks.
TLS Version	Set this parameter based on the connected Management System-1 . TLS1.2 or a later version is recommended.
Remote Access	Only monitoring, Management (permanent authorization), and Management (temporary authorization) are supported. When the remaining authorization time becomes 0, the system automatically switches to the monitoring-only mode.
Remote Control Time(min)	Set this parameter based on the actual authorization time.

- **Method 2:** When the SmartLogger connects to a third-party management system using the unencrypted Modbus TCP protocol, set Modbus TCP parameters and click **Submit**.

Figure 6-11 Setting Modbus TCP parameters



IL03J00008

Parameter	Description
Link setting	<p>Modbus TCP is a universal standard protocol used to connect to a third-party management system. Because there is no security authentication mechanism, data transmitted by Modbus TCP is not encrypted. To reduce network security risks, the function of connecting to a third-party management system using Modbus TCP is disabled by default. This protocol can transmit the running data and control commands of PV plants, which may cause user data breach and control permission theft. Therefore, exercise caution when using this protocol. Users are liable for any loss caused by the use of this protocol to connect to a third-party management system (non-secure protocol). Users are advised to take measures at the PV plant level to reduce security risks, or use Huawei management system to mitigate the risks.</p> <p>To use this function, set this parameter to Enable(Limited) or Enable(Unlimited).</p> <ul style="list-style-type: none"> • If this parameter is set to Enable(Limited), the SmartLogger can connect to a maximum of five preset third-party management systems. • If this parameter is set to Enable(Unlimited), the SmartLogger can connect to a maximum of five third-party management systems with a valid IP address.
Client N IP Address NOTE N is 1, 2, 3, 4, or 5.	If Link setting is set to Enable(Limited) , set this parameter based on the IP address of the third-party management system.
Address mode	The value can be Comm. Address or Logical address . If the communications address of the device connected to the SmartLogger is unique, you are advised to select Comm. Address . In other cases, you must select Logical address .
SmartLogger address	Set this parameter to the communication address of the SmartLogger.

- **Method 3:** When the SmartLogger connects to a third-party management system over IEC104, set IEC104 parameters and click **Submit**.

Figure 6-12 Setting IEC104 parameters

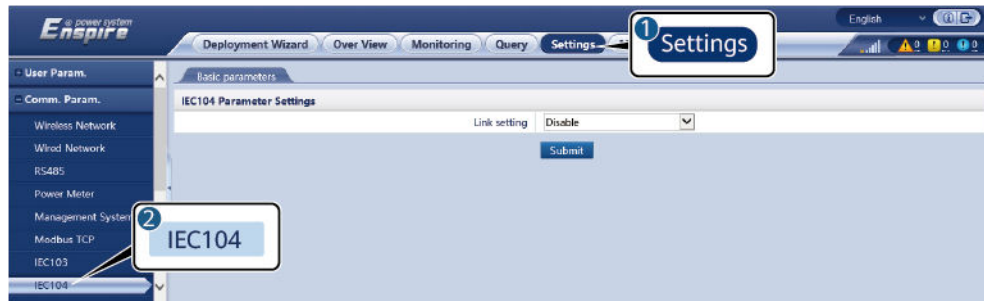

IL04J00004

Tab	Parameter	Description
Basic parameters	Link setting	<p>IEC104 is a universal standard protocol used to connect to a third-party management system. Because there is no security authentication mechanism, data transmitted by IEC104 is not encrypted. To reduce network security risks, the function of connecting to a third-party management system using IEC104 is disabled by default. This protocol can transmit the running data and control commands of PV plants, which may cause user data breach and control permission theft. Therefore, exercise caution when using this protocol. Users are liable for any loss caused by the use of this protocol to connect to a third-party management system (non-secure protocol). Users are advised to take measures at the PV plant level to reduce security risks, or use Huawei management system to mitigate the risks.</p> <p>To use this function, set this parameter to Enable(Limited) or Enable(Unlimited).</p> <ul style="list-style-type: none"> • If this parameter is set to Enable(Limited), the SmartLogger can connect to a maximum of five preset third-party management systems. • If this parameter is set to Enable(Unlimited), the SmartLogger can connect to a maximum of five third-party management systems with a valid IP address.
	Public IP address	Set these parameters as required.
IEC104-N NOTE N is 1, 2, 3, 4, or 5.	IEC104-N IP	If Link setting is set to Enable(Limited) , set this parameter based on the IP address of the third-party management system.
	Teleindication default segment	Set these parameters as required.
	Telemetry default segment	

Tab	Parameter	Description
	Forwarding Tableconfiguration	NOTE After the IEC104 configuration file exported from the SmartLogger and the IEC104 information files delivered with devices are correctly configured in a third-party management system, the third-party management system will be able to monitor devices connected to the SmartLogger over the IEC104 protocol.
Common Configuration	Teleindication default segment	If Link setting is set to Enable(Unlimited) , set these parameters as required. NOTE After the IEC104 configuration file exported from the SmartLogger and the IEC104 information files delivered with devices are correctly configured in a third-party management system, the third-party management system will be able to monitor devices connected to the SmartLogger over the IEC104 protocol.
	Telemetry default segment	
	Forwarding Tableconfiguration	

NOTE

Choose **Settings > Other Parameters**, and set **IEC104 Push Data Period** to specify the interval for the SmartLogger to push data to a third-party management system over IEC104. If **IEC104 Push Data Period** is set to 0s, there is no limit on the interval at which the SmartLogger sends IEC104 data.

----End

6.3.3 Setting RS485 Communications Parameters

Set RS485 parameters and click **Submit**.

Figure 6-13 Setting RS485 parameters

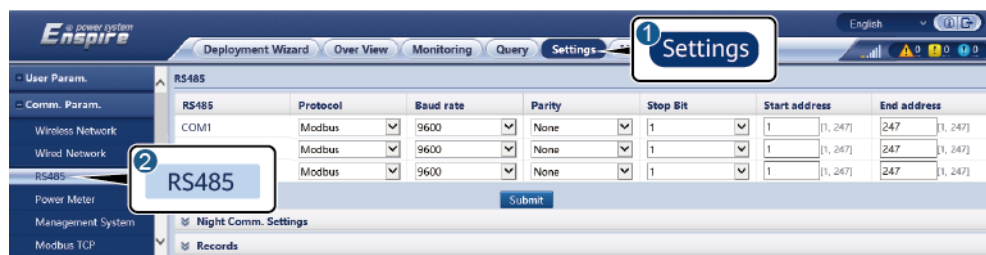

IL03J00010

NOTE

When the SmartModule is connected to the SmartLogger, the device name of the SmartModule is **Module(M1)**, and the corresponding port is **M1.COM**.

RS485

Protocol, Baud rate, Parity, and Stop Bit must be set to the same values for the devices connected to the same COM port.

Parameter	Description
Protocol	<p>Set this parameter based on the protocol type of the connected device.</p> <p>The value can be Modbus, IEC103, DL/T645, Modbus-Slave, or Modbus-Control.</p> <p>NOTE</p> <ul style="list-style-type: none"> When the SmartLogger serves as a slave node to interconnect with a third-party device over Modbus-RTU, set Protocol to Modbus-Slave. When the connected solar inverter performs rapid power grid scheduling using both MBUS and RS485, set Protocol to Modbus-Control.
Baud rate	<p>Set this parameter based on the baud rate of the connected device.</p> <p>The value can be 1200, 2400, 4800, 9600, 19200, or 115200.</p>
Parity	<p>Set this parameter based on the parity mode of the connected device.</p> <p>The value can be None, Odd parity, or Even parity.</p>
Stop Bit	<p>Set this parameter based on the stop bit of the connected device.</p> <p>The value can be 1 or 2.</p>
Start address	<p>$1 \leq \text{Start address} \leq \text{Communication address of the connected device} \leq \text{End address} \leq 247$</p> <p>The address segments of COM ports can overlap.</p> <p>NOTE</p> <p>The start and end addresses have no impact on the devices that have been connected.</p>
End address	

Night Comm. Settings

If device information query is not required at night, enable **Night silent**.

Parameter	Description
Night silent	Specifies whether the night silent mode is enabled.
Enter time	Specifies the time for entering the night silent mode.

Parameter	Description
Exit time	Specifies the time for exiting the night silent mode.
Wakeup period	Specifies the wakeup period for the night silent mode.

Records

The SmartLogger supports exporting of MBUS and RS485 communication packets.

Set **Choose port** and click **Start** to start packet recording. Then, click **Export** to stop packet recording and export the packets.

Parameter	Description
Choose port	Specifies the port for recording packets.

6.3.4 Setting Parameters for the Slave SmartLogger

Step 1 Log in to the slave SmartLogger WebUI, set Modbus TCP parameters, and click **Submit**.

Figure 6-14 Setting Modbus TCP parameters

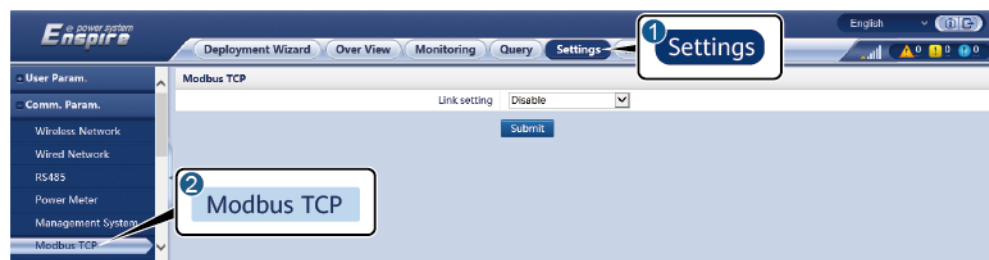

IL03J00008

Parameter	Description
Link setting	Set this parameter to Enable(Limited) .
Client N IP Address	Set this parameter to the IP address of the master SmartLogger.
Address mode	The value can be Comm. Address or Logical address . If the communications address of the device connected to the SmartLogger is unique, you are advised to select Comm. Address . In other cases, you must select Logical address .

Parameter	Description
SmartLogger address	Set this parameter to the communications address of the slave SmartLogger.

Step 2 Log in to the WebUI of the master SmartLogger, set access parameters for the slave SmartLogger, and click **Add Devices**.

Figure 6-15 Setting access parameters

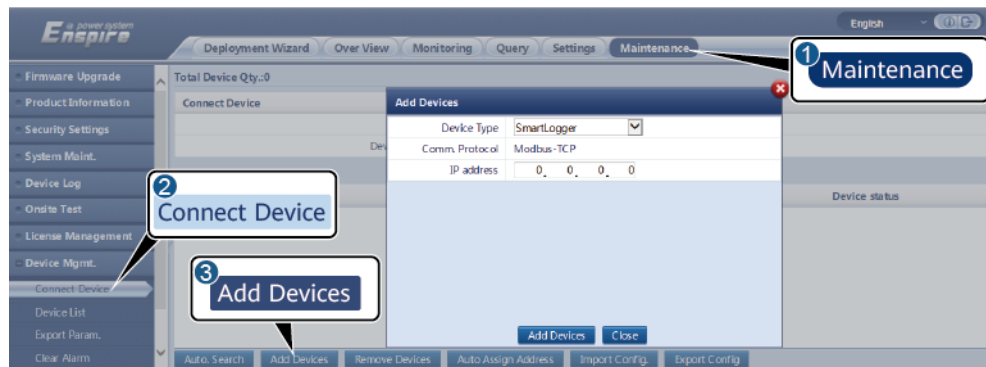

IL03J00011

Parameter	Description
Device Type	Set this parameter to SmartLogger .
IP address	Set this parameter to the IP address of the slave SmartLogger.

----End

6.3.5 Setting MBUS Parameters

Procedure

- Step 1** Set access parameters.
- Set parameters for the built-in MBUS and click **Submit**.

Figure 6-16 Setting parameters for the built-in MBUS

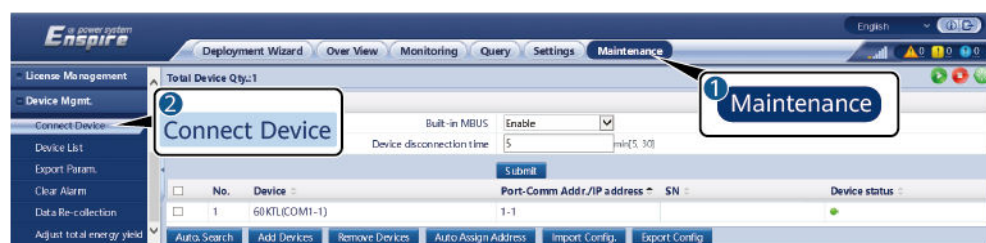

IL03J00012

Parameter	Description
Built-in MBUS	<ul style="list-style-type: none"> If the SmartLogger communicates with the solar inverter using a built-in MBUS, set this parameter to Enable. If only RS485 communication is used between the SmartLogger and the solar inverter and third-party device, set this parameter to Disable.
Device disconnection time	Specifies the duration for determining device disconnection.

- Set access parameters for an external MBUS.
 - Method 1:** Click **Auto. Search** to connect the MBUS.
 - Method 2:** Click **Add Devices**, set access parameters, and click **Add Devices**.

Figure 6-17 Setting access parameters for an external MBUS

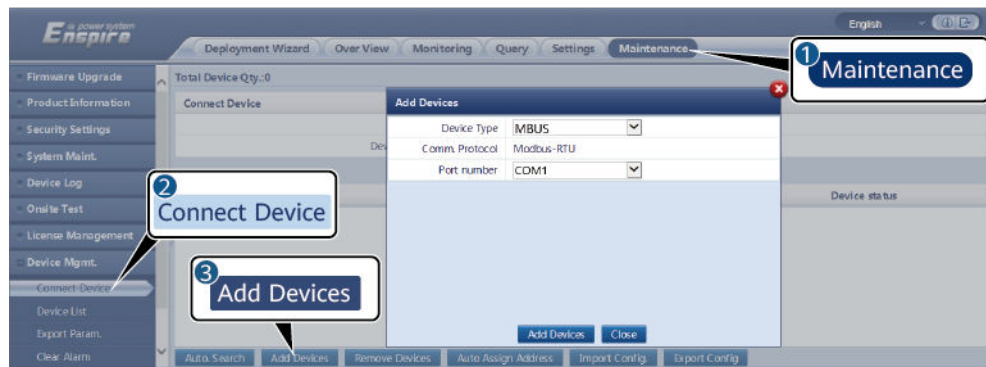

IL03J00013

Parameter	Description
Device type	Set this parameter to MBUS .
Port number	Set this parameter to the serial number of the COM port connected to the MBUS.

Step 2 Set networking parameters.

- Set parameters for the built-in MBUS networking.

Figure 6-18 Setting the built-in MBUS networking

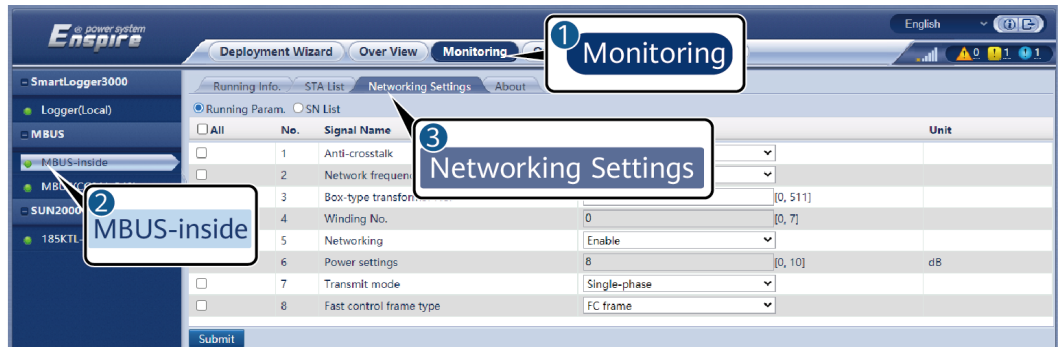

IL03J00014

Category	Parameter	Description
Running Param.	Anti-crosstalk	Set this parameter to Enable . When the transformer substation number and winding number of the solar inverter are the same as those of the MBUS, or the solar inverter SN is in the SN list, the solar inverter can connect to the SmartLogger over an MBUS network.
	Network frequency band	Set this parameter as required.
	Box-type transformer No.	Set this parameter based on the number of the transformer substation connected to the SmartLogger.
	Winding No.	In multi-split transformer substation scenarios, set this parameter based on the number of the winding of the transformer station connected to the SmartLogger.
	Networking	<ul style="list-style-type: none"> When the SmartLogger communicates with the solar inverter over MBUS, set Networking to Enable. When the SmartLogger communicates with the solar inverter only over RS485, set Networking to Disable.
	Power settings	This parameter is used to adjust the transmit power of MBUS signals. A larger value indicates a higher transmit power and better networking capability. The default value is 8 (NA is displayed) . You can set this parameter based on actual requirements.

Category	Parameter	Description
	Transmit mode	<ul style="list-style-type: none"> Set this parameter to Single-phase in the power grid fast control scenario and to Three-phase in other scenarios. If this parameter is set to Single-phase, ensure that the MBUS three-phase AC power cable connection of the SmartLogger is the same as that of the inverter. Otherwise, the inverter communication may be disconnected or some commands may be lost.
	Fast control frame type	<ul style="list-style-type: none"> Frame type used by the MBUS module for power grid fast control. The MBUS module adaptively selects FC frame or Common frame.
SN List	N/A	<ul style="list-style-type: none"> Maintain the solar inverter SN list. You can click Synchronize to synchronize the transformer substation number and winding number of the MBUS to the solar inverters in the SN list.

- Set parameters for the external MBUS networking.

Figure 6-19 Setting the external MBUS networking

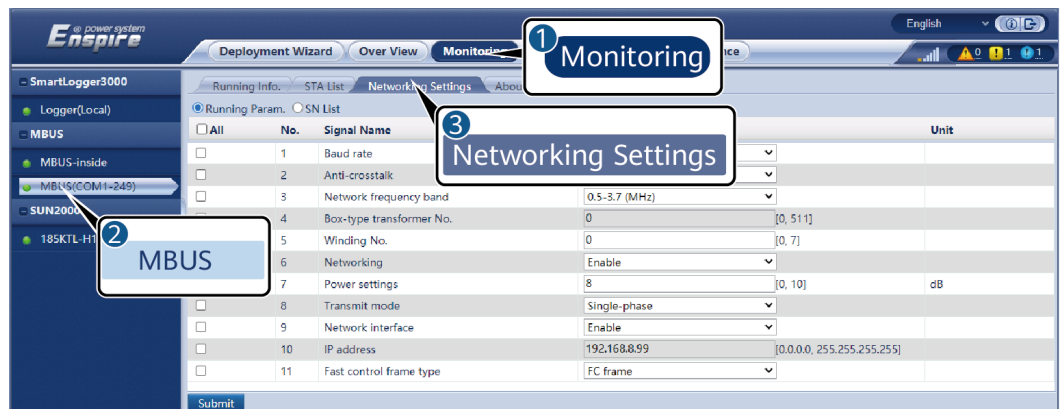

Category	Parameter	Description
Running Param.	Baud rate	Retain the default value 115200 for optimal communications performance.

Category	Parameter	Description
	Anti-crosstalk	Set this parameter to Enable . When the transformer substation number and winding number of the solar inverter are the same as those of the MBUS, or the solar inverter SN is in the SN list, the solar inverter can connect to the SmartLogger over an MBUS network.
	Network frequency band	Set this parameter as required.
	Box-type transformer No.	Set this parameter based on the number of the transformer substation connected to the SmartLogger.
	Winding No.	In multi-split transformer substation scenarios, set this parameter based on the number of the winding of the transformer station connected to the SmartLogger.
	Networking	<ul style="list-style-type: none"> When the SmartLogger communicates with the solar inverter over MBUS, set Networking to Enable. When the SmartLogger communicates with the solar inverter only over RS485, set Networking to Disable.
	Power settings	This parameter is used to adjust the transmit power of MBUS signals. A larger value indicates a higher transmit power and better networking capability. The default value is 8 (NA is displayed) . You can set this parameter based on actual requirements.
	Transmit mode	<ul style="list-style-type: none"> Set this parameter to Single-phase in the power grid fast control scenario and to Three-phase in other scenarios. If this parameter is set to Single-phase, ensure that the MBUS three-phase AC power cable connection of the SmartLogger is the same as that of the inverter. Otherwise, the inverter communication may be disconnected or some commands may be lost.

Category	Parameter	Description
	Network interface	<ul style="list-style-type: none"> This parameter is used to enable communication between the MBUS module and the SmartLogger network interface. The default value is Disable. Set this parameter to Enable only in the power grid fast control scenario. Ensure that the LAN interface on the SmartLogger or SmartModule is connected to the network interface on the MBUS module.
	IP address	IP address of the MBUS module. The default value is 192.168.8.249 . Change the value only when an IP address conflict occurs.
	Fast control frame type	<ul style="list-style-type: none"> Frame type used by the MBUS module for power grid fast control. The MBUS module adaptively selects FC frame or Common frame.
SN List	N/A	<ul style="list-style-type: none"> Maintain the solar inverter SN list. You can click Synchronize to synchronize the transformer substation number and winding number of the MBUS to the solar inverters in the SN list.

----End

6.3.6 Setting SUN2000 Parameters

Procedure

Step 1 Set access parameters.

- **Method 1:** Click **Auto. Search** to connect to the solar inverter.
- **Method 2:** Click **Add Devices**, set access parameters, and click **Add Devices**.

Figure 6-20 Setting access parameters

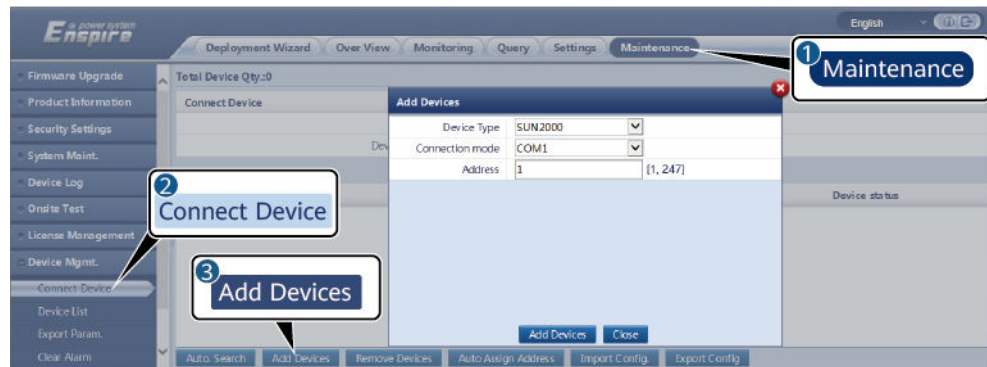

IL03J00015

Parameter	Description
Device type	Set this parameter to SUN2000 .
Connection mode	<ul style="list-style-type: none"> If the solar inverter uses the MBUS for communication, set this parameter to MBUS. If the solar inverter uses RS485 for communication, set this parameter to the COM port connected to the solar inverter.
Address	Set this parameter to the communication address of the solar inverter.

Step 2 Set running parameters and click **Submit**.

NOTICE

Before setting the running parameters of the solar inverter, ensure that the DC side of the solar inverter is energized.

Figure 6-21 Setting running parameters

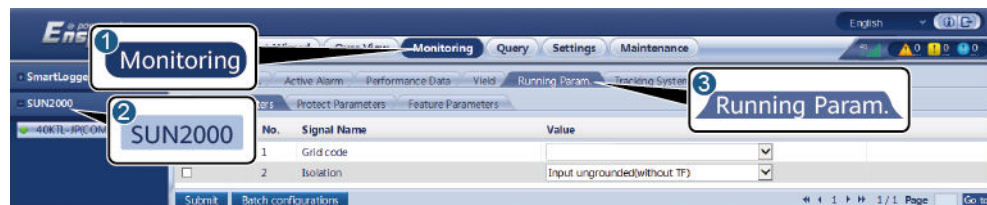

IL04J00005

----End

6.3.6.1 Running Parameters

Grid Parameters

Parameter	Description
Grid Code	Set this parameter based on the grid code of the country or region where the inverter is used and the inverter application scenario.
Isolation settings	Set the working mode of the inverter based on the grounding status at DC side and the connection to the power grid.
Output mode	Specifies whether the inverter output has a neutral wire based on the application scenario.
PQ mode	If this parameter is set to PQ mode 1 , the maximum AC output power equals the maximum apparent power. If this parameter is set to PQ mode 2 , the maximum AC output power equals the rated output power.
Automatically start upon grid recovery	Specifies whether to allow the inverter to automatically start after the power grid recovers.
Grid connected recovery time from grid faults (s)	Specifies the time after which the inverter begins restarting after the power grid recovers.
Grid reconnection voltage upper limit (V)	The standards of certain countries and regions require that after the inverter shuts down for protection due to a fault, if the power grid voltage is higher than Grid reconnection voltage upper limit , the inverter is not allowed to reconnect to the grid.
Grid reconnection voltage lower limit (V)	The standards of certain countries and regions require that after the inverter shuts down for protection due to a fault, if the power grid voltage is lower than Grid reconnection voltage lower limit , the inverter is not allowed to reconnect to the grid.
Grid reconnection frequency upper limit (Hz)	The standards of certain countries and regions require that after the inverter shuts down for protection due to a fault, if the power grid frequency is higher than Grid reconnection frequency upper limit , the inverter is not allowed to reconnect to the grid.
Grid reconnection frequency lower limit (Hz)	The standards of certain countries and regions require that after the inverter shuts down for protection due to a fault, if the power grid frequency is lower than Grid reconnection frequency lower limit , the inverter is not allowed to reconnect to the grid.
Reactive power compensation (cos ϕ -P) trigger voltage (%)	Specifies the voltage threshold for triggering reactive power compensation based on the cos ϕ -P curve.
Reactive power compensation (cos ϕ -P) exit voltage (%)	Specifies the voltage threshold for exiting reactive power compensation based on the cos ϕ -P curve.

Protection Parameters

Parameter	Description
Insulation resistance protection threshold (MΩ)	To ensure device safety, the inverter detects the insulation resistance of the input side with respect to ground when it starts a self-check. If the detected value is less than the preset value, the inverter does not connect to the grid.
Voltage unbalance protection threshold (%)	Specifies the inverter protection threshold when the power grid voltage is unbalanced.
Phase protection point (°)	The Japanese standard requires that during passive islanding detection, protection should be triggered if an abrupt voltage phase change is detected.
Phase angle offset protection	The standards of certain countries and regions require that the inverter needs to be protected when the phase angle offset of the power grid three phases exceeds a certain value.
10-min overvoltage protection threshold (V)	Specifies the 10-minute overvoltage protection threshold.
10-min overvoltage protection duration (ms)	Specifies the 10-minute overvoltage protection duration.
Level-N OV protection (Hz)	Specifies the level-N grid overvoltage protection threshold.
Level-N OV protection time (ms)	Specifies the level-N grid overvoltage protection duration.
Level-N UV protection (Hz)	Specifies the level-N grid undervoltage protection threshold.
Level-N UV protection time (ms)	Specifies the level-N grid undervoltage protection duration.
Level-N OF protection (Hz)	Specifies the level-N grid overfrequency protection threshold.
Level-N OF protection time (ms)	Specifies the level-N grid overfrequency protection duration.
Level-N UF protection (Hz)	Specifies the level-N grid underfrequency protection threshold.
Level-N UF protection time (ms)	Specifies the level-N grid underfrequency protection duration.

NOTE

N is 1, 2, 3, 4, 5, or 6.

Feature Parameters

Parameter	Description
MPPT multi-peak scanning	When the inverter is used in scenarios where PV strings are greatly shaded, set this parameter to Enable , and then the inverter will perform MPPT scanning at regular intervals to locate the maximum power.
MPPT multi-peak scan interval (min)	Specifies the MPPT scanning interval.
RCD enhancement	RCD refers to the residual current of the inverter to the ground. To ensure device and personal safety, RCD should be limited to the specified value in the standard. If an AC switch with a residual current detection function is installed outside the inverter, this function should be enabled to reduce the residual current generated when the inverter is running, thereby preventing the AC switch from misoperations.
Night-time reactive power output	In some specific application scenarios, a power grid company requires that the inverter can perform reactive power compensation at night to ensure that the power factor of the local power grid meets requirements. This parameter is displayed when Isolation settings is set to Input ungrounded, with TF .
PID protection at night	When the inverter outputs reactive power at night and this parameter is set to Enable , the inverter will shut down automatically if it detects abnormal status of the PID compensation.
Strong adaptability	If the power grid short-circuit capacity or PV plant installed capacity is less than 3, the power grid quality will be affected if the power grid impedance is too high, which may cause the inverter to malfunction. In this case, if the inverter is required to work properly, set this parameter to Enable .
Power quality optimization mode	If this parameter is set to Enable , the inverter output current harmonics will be optimized.

Parameter	Description
PV module type	<p>This parameter is used to set different types of PV modules and the shutdown time of the concentration PV module. If the concentration PV modules are shaded, the power drops drastically to 0 and the inverter shuts down. The energy yield would be affected since it takes too long for the power to resume and inverter to restart. The parameter does not need to be set for crystalline silicon and filmy PV modules.</p> <ul style="list-style-type: none">• If this parameter is set to Crystalline silicon or Film, the inverter automatically detects the power of PV modules when they are shaded and shuts down if the power is too low.• When concentration PV modules are used:<ul style="list-style-type: none">- If this parameter is set to CPV 1, the inverter can quickly restart in 60 minutes if the input power of PV modules drops drastically due to shading.- If this parameter is set to CPV 2, the inverter can quickly restart in 10 minutes if the input power of PV modules drops drastically due to shading.
Built-in PID compensation direction	<p>When the external PID module compensates the PID voltage for the PV system, set Built-in PID compensation direction to the actual compensation direction of the PID module so that the inverter can output reactive power at night.</p> <p>This parameter is displayed when PV module type is set to Crystalline silicon. Select PV-positive offset for P-type PV modules. Select PV+ negative offset for N-type PV modules.</p>
PID running mode	Specifies the operation mode of the inverter built-in PID.
PID nighttime off-grid repair	Specifies whether to enable the PID nighttime off-grid repair.
PID daytime off-grid repair	Specifies whether to enable the PID daytime off-grid repair.
String connection mode	<p>Specifies the connection mode of PV strings.</p> <ul style="list-style-type: none">• When PV strings connect to the inverter separately (All PV strings separated), there is no need to set this parameter. The inverter can automatically detect the connection mode of the PV strings.• When PV strings connect to one another in parallel outside the inverter and then connect to it independently (All PV strings connected), set this parameter to All PV strings connected.
Automatic OFF due to communication interrupted	<p>The standards of certain countries and regions require that the inverter must shut down after the communication is interrupted for a certain time.</p> <p>If Automatic OFF due to communication interrupted is set to Enable and the inverter communication is interrupted for a specified time (set by Communication interruption duration), the inverter will automatically shut down.</p>

Parameter	Description
Communication interruption duration (min)	Specifies the duration for determining communication interruption. Used for automatic shutdown for protection in case of communication interruption.
Automatic ON due to communication resumed	If this parameter is set to Enable , the inverter automatically starts after communication recovers. If this parameter is set to Disable , the inverter needs to be started manually after communication recovers.
Soft start/boot time (s)	Specifies the duration for the power to gradually increase when the inverter starts.
AFCI	The North American standard requires that the inverter should have DC arc detection function.
AFCI detection adaptive mode	Adjusts the sensitivity of arc detection.
AFCI self-test	Send the AFCI self-check command manually.
Current error during the scan (A)	To prevent inaccurate scanning caused by sunlight change, the current change of PV strings operating properly should be monitored when the I-V curves of PV strings are being scanned. When the current exceeds the specified value, it is determined that the sunlight changes. The I-V curves should be scanned again.
OVGR associated shutdown	If this parameter is set to Enable , the inverter shuts down after receiving the OVGR signal. If this parameter is set to Disable , the inverter does not shut down after receiving the OVGR signal.
Dry contact function	Identifies the dry contact signals from the SmartLogger. Set this parameter to OVGR for OVGR signals, and set it to NC for other signals. This parameter is displayed if the Japanese grid code is selected.
Commanded shutdown hold after power recovery	The standards of certain countries and regions require that if the inverter is shut down after receiving a command and powered on again after power recovers, it should still be in commanded shutdown state.
Night-time hibernation	The inverter monitors PV strings at night. If this parameter is set to Enable , the monitoring function of the inverter will hibernate at night to reduce power consumption.
MBUS communication	For inverters that support RS485 communication and MBUS communication, you are advised to set this parameter to Disable to reduce power consumption.
RS485-2 communication	If this parameter is set to Enable , the RS485-2 port can be used. If the port is not used, you are advised to set this parameter to Disable to reduce power consumption.

Parameter	Description
Delay upgrade	<p>This parameter is mainly used in the upgrade scenarios where the PV power supply is disconnected at night due to no sunlight or unstable at dawn or dusk due to poor sunlight.</p> <p>After the inverter starts to upgrade, if Delay upgrade is set to Enable, the upgrade package is loaded first. After the PV power supply recovers and the activation conditions are met, the inverter automatically activates the upgrade.</p>
String monitor	<p>The inverter monitors PV strings in real time. If any PV string is abnormal (such as the PV string is shaded or the electric energy yield decreases), the inverter generates an alarm to remind maintenance personnel to maintain the PV string in a timely manner.</p> <p>If PV strings are often shaded, you are advised to set String monitor to Disable to prevent false alarms.</p>
String detection low power delay (min)	<p>Specifies the delay time for generating abnormal string alarms when the inverter detects that a PV string is working with low power. This parameter is mainly used in the scenario where PV strings are shaded for a long time in the morning and evening, and is used to prevent false alarms.</p>
String detection high power delay (min)	<p>Specifies the delay time for generating abnormal string alarms when the inverter detects that a PV string is working with high power.</p>
String detection power segment division percentage (%)	<p>Specifies the thresholds for determining whether a PV string is working with high power or low power. This parameter is used to distinguish the working status of PV strings.</p>
String detection reference asymmetric coefficient	<p>Specifies the threshold for determining PV string exception. The false alarms caused by fixed shadow shading can be controlled by changing this parameter.</p>
String detection starting power percentage (%)	<p>Specifies the threshold for starting PV string exception detection. The false alarms caused by fixed shadow shading can be controlled by changing this parameter.</p>
OFF at 0% power limit	<p>If this parameter is set to Enable, the inverter shuts down after receiving the 0% power limit command. If this parameter is set to Disable, the inverter does not shut down after receiving the 0% power limit command.</p>
Maximum apparent power (kVA)	<p>Specifies the output upper threshold for the maximum apparent power to adapt to the capacity requirements of standard and customized inverters.</p>
Maximum active power (kW)	<p>Specifies the output upper threshold for the maximum active power to adapt to different market requirements.</p>

Parameter	Description
Adjust total energy yield (kWh)	Specifies the initial energy yield of the inverter. This parameter is used in inverter replacement scenarios. Set the initial energy yield of the new inverter to the total energy yield of the old inverter to ensure continuous statistics of cumulative energy yield.
Duration for determining short-time grid disconnection (ms)	The standards of certain countries and regions require that the inverter should not disconnect from the power grid if the power grid experiences a short-time failure. After the fault is rectified, the inverter output power needs to be quickly restored.
Buzzer	If this parameter is set to Enable , the buzzer sounds when the DC input cable is incorrectly connected. If this parameter is set to Disable , the buzzer does not sound when the DC input cable is incorrectly connected.
LVRT	LVRT is short for low voltage ride-through. When the grid voltage is abnormally low for a short time, the inverter cannot disconnect from the power grid immediately and has to work for some time.
Threshold for triggering LVRT (V)	Specifies the threshold for triggering LVRT. The threshold settings should meet the local grid standard.
LVRT reactive power compensation factor	During LVRT, the inverter needs to generate reactive power to support the power grid. This parameter is used to set the reactive power generated by the inverter.
HVRT	HVRT is short for high voltage ride-through. When the grid voltage is abnormally high for a short time, the inverter cannot disconnect from the power grid immediately and has to work for some time.
Threshold for triggering HVRT (V)	Specifies the threshold for triggering HVRT. The threshold settings should meet the local grid standard.
HVRT compensation power factor of reactive power in positive sequence	During HVRT, the inverter needs to generate reactive power to support the power grid. This parameter is used to set the reactive power generated by the inverter.
VRT exit hysteresis threshold	Specifies the LVRT/HVRT recovery threshold.
LVRT undervoltage protection shield	Specifies whether to shield the undervoltage protection function during LVRT.
Grid voltage protection shield during VRT	Specifies whether to shield the undervoltage protection function during LVRT or HVRT.
Grid voltage jump triggering threshold (%)	Specifies the LVRT or HVRT threshold for triggering a transient voltage jump of a power grid. A transient voltage jump indicates that the inverter cannot immediately disconnect from the power grid when the power grid is abnormal due to transient changes.

Parameter	Description
Zero current due to power grid fault	Specifies the working mode of the solar inverter during LVRT or HVRT. If this parameter is set to Enable , the output current of the solar inverter will be less than 10% of the rated current during LVRT or HVRT.
Active islanding protection	Specifies whether to enable the active islanding protection function.
Passive islanding protection	Specifies whether to enable the passive islanding protection function.
Voltage rise suppression	The standards of certain countries and regions require that when the output voltage exceeds a certain value, the inverter must suppress voltage rise by outputting reactive power and reducing active power.
Voltage rise suppressing reactive power adjustment point (%)	The standards of certain countries and regions require that the inverter generate a certain amount of reactive power when the output voltage exceeds a certain value.
Voltage rise suppressing active power derating point (%)	The standards of certain countries and regions require that the active power of the inverter be derated according to a certain slope when the output voltage exceeds a certain value.
Voltage rise suppression P-U curve	The standards of certain countries and regions require that the P-U curve be set.
Voltage rise suppression Q-U curve	The standards of certain countries and regions require that the Q-U curve be set.
Frequency change rate protection	Set this parameter to Enable to protect the inverter when the grid frequency changes too fast.
Frequency change rate protection threshold (Hz/s)	Specifies the frequency change rate protection threshold.
Frequency change rate protection duration (s)	The inverter is protected when the grid frequency change duration exceeds the value.
Soft start time after grid failure (s)	Specifies the time for the power to gradually increase when the inverter restarts after the power grid recovers.

Power Adjustment Parameters

Parameter	Description
Remote power schedule	If this parameter is set to Enable , the inverter responds to the scheduling instruction from the remote port. If this parameter is set to Disable , the inverter does not respond to the scheduling instruction from the remote port.

Parameter	Description
Schedule instruction valid duration (s)	Specifies the time for maintaining the scheduling instruction. When this parameter is set to 0, the scheduling instruction takes effect permanently.
Maximum apparent power (kVA)	Specifies the output upper threshold for the maximum apparent power to adapt to the capacity requirements of standard and customized inverters.
Maximum active power (kW)	Specifies the output upper threshold for the maximum active power to adapt to different market requirements.
OFF at 0% power limit	If this parameter is set to Enable , the inverter shuts down after receiving the 0% power limit command. If this parameter is set to Disable , the inverter does not shut down after receiving the 0% power limit command.
Active power change gradient (%/s)	Specifies the change speed of the inverter active power.
Derated by fixed active power (kW)	Adjusts the active power output of the inverter by fixed value.
Derated by active power % (%)	Adjusts the active power output of the inverter by percentage. If this parameter is set to 100 , the inverter outputs based on the maximum output power.
Reactive power change gradient (%/s)	Specifies the change speed of the inverter reactive power.
Plant active power gradient (min/100%)	Specifies the rate of active power rise due to sunlight changes.
Average active power filtering time (ms)	Specifies the period of active power rise due to sunlight changes. This parameter is used with Plant active power gradient .
PF (U) voltage detection filtering time (s)	Specifies the time for filtering the grid voltage in the PF-U curve.
Reactive power adjustment time (s)	Specifies the adjustment time for the reactive power to reach the target value during reactive power adjustment.
Power factor	Specifies the power factor of the inverter.
Reactive power compensation (Q/S)	Specifies the reactive power output by the inverter.
Night-time reactive power compensation (Q/S)	During the reactive power compensation at night, the reactive power is scheduled by percentage.
Night-time reactive power output	In some specific application scenarios, a power grid company requires that the inverter can perform reactive power compensation at night to ensure that the power factor of the local power grid meets requirements.

Parameter	Description
Enable reactive power parameters at night	When this parameter is set to Enable , the inverter outputs reactive power based on the setting of Reactive power compensation at night . Otherwise, the inverter executes the remote scheduling command.
Night-time reactive power compensation (kVar)	During the reactive power compensation at night, the reactive power is scheduled by fixed value.
Overfrequency derating	If this parameter is set to Enable , the active power of the inverter will be derated according to a certain slope when the grid frequency exceeds the frequency that triggers overfrequency derating.
Frequency for triggering overfrequency derating (Hz)	The standards of certain countries and regions require that the output active power of inverters be derated when the power grid frequency exceeds a certain value.
Frequency for exiting overfrequency derating (Hz)	Specifies the frequency threshold for exiting overfrequency derating.
Cutoff frequency of overfrequency derating (Hz)	Specifies the frequency threshold for cutting off overfrequency derating.
Cutoff power of overfrequency derating (%)	Specifies the power threshold for cutting off overfrequency derating.
Frequency detection filtering time (ms)	Specifies the frequency detection filter time.
Overfrequency derating power drop gradient (%/s)	Specifies the decrease rate of the overfrequency derating power.
Power recovery gradient of overfrequency derating (%/min)	Specifies the recovery rate of the overfrequency derating power.
Voltage derating	If this parameter is set to Enable , the active power of the inverter will be derated according to a certain slope when the grid voltage exceeds the voltage that triggers overfrequency derating.
Voltage derating start point (V)	Specifies the start point for voltage derating.
Cut-off point of voltage derating (V)	Specifies the stop point for voltage derating.
Voltage derating cut-off power (V)	Specifies the power threshold for cutting off voltage derating.
Communication disconnection fail-safe	In the inverter export limitation scenario, if this parameter is set to Enable , the inverter will perform active power derating by percentage when the communication between the inverter and the SmartLogger or Smart Dongle is disconnected for more than the time specified by Communication disconnection detection time .

Parameter	Description
Communication disconnection detection time (s)	Specifies the fail-safe detection time for the disconnection between the inverter and the SmartLogger or Smart Dongle.
Active power output limit for fail-safe (%)	Specifies the derating value of the inverter active power by percentage.
Apparent power baseline (kVA)	Adjusts the apparent output baseline of the inverter.
Active power baseline (kW)	Adjusts the active output baseline of the inverter.
Frequency modulation control	The standards of certain countries and regions require that if the power grid frequency fluctuates around a certain value, the inverter needs to fine-tune the active power output based on Frequency modulation control droop to help stabilize the power grid frequency. In this case, set this parameter to Enable
Adjustment ratio of frequency modulation control	Specifies the droop of the active power output.
Underfrequency rise power	The standards of certain countries and regions require that if the power grid frequency is lower than Frequency for triggering of underfrequency rise power , the inverter needs to increase the active power output to help increase the power grid frequency. In this case, set this parameter to Enable .
Frequency for triggering of underfrequency rise power (Hz)	Specifies the frequency threshold of Underfrequency rise power .
Power recovery gradient of underfrequency rise (%/min)	Specifies the recovery rate of Underfrequency rise power .
Cutoff frequency of underfrequency rise power (Hz)	Specifies the cutoff frequency of Underfrequency rise power .
Cutoff power of underfrequency rise power (%)	Specifies the cutoff power of Underfrequency rise power .
Frequency for exiting of underfrequency rise power (Hz)	Specifies the exit frequency of Underfrequency rise power .

PV String Access Detection

- PV string access detection applies to large-scale commercial ground PV plants with PV strings facing the same direction.
- In AC or DC power limiting scenarios:

- If the PV string access type has not been identified, **PV string access type** will be displayed as **Disconnection**. The PV string access type can be identified only when the solar inverters restore to the non-power limiting state and the current of all connected PV strings reaches the **startup current**.
- If the PV string access type has been identified, when a certain PV string connected to the 2-in-1 terminals is lost, no alarm will be generated. If a certain PV string connected to the 2-in-1 terminals is restored, the access type cannot be identified. You can determine whether both 2-in-1 PV strings are restored only when the PV string current reaches **Startup current for 2-in-1 detection**.
- After setting the parameters, you can go to the **Running Info.** tab page to check whether the PV string connection status is normal.

Table 6-4 Parameter description

Parameter	Parameter Description
PV String Access Detection	PV String Access Detection is set to Disable by default. After solar inverters are connected to the power grid, set PV String Access Detection to Enable .
Startup current	When the current of all connected PV strings reaches the preset value, the PV string access detection function is enabled. NOTE Startup current setting rules: <ul style="list-style-type: none"> • Startup current = $I_{sc} (S_{tc}) \times 0.6$ (rounded up). For details about $I_{sc} (S_{tc})$, see the PV module nameplate. • Default startup current (5 A): applicable to the scenarios where the short-circuit current $I_{sc} (S_{tc})$ is greater than 8 A for the monocrystalline and polycrystalline PV modules.
Startup current for 2-in-1 detection	When the current of a PV string reaches Startup current for 2-in-1 detection , the PV string is automatically identified as 2-in-1 . You are advised to retain the default settings.
PV string <i>N</i> access type NOTE <i>N</i> is the DC input terminal number of the solar inverter.	Set this parameter based on the type of the PV string connected to DC input terminal <i>N</i> of the solar inverter. Currently, the options are as follows: Automatic identification (default value), Disconnection, Single PV string, and 2-in-1. You are advised to retain the default value. If the value is incorrectly set, the PV string access type may be incorrectly identified and alarms may be generated by mistake for the PV string access status.

6.3.6.2 Tracking System

If a PV string uses a tracking system with a controller, set tracking system parameters on the **Tracking System** tab page.

6.3.6.3 Characteristic Curves

Step 1 Set characteristic curve parameters and click **Submit**.

Figure 6-22 Characteristic curves

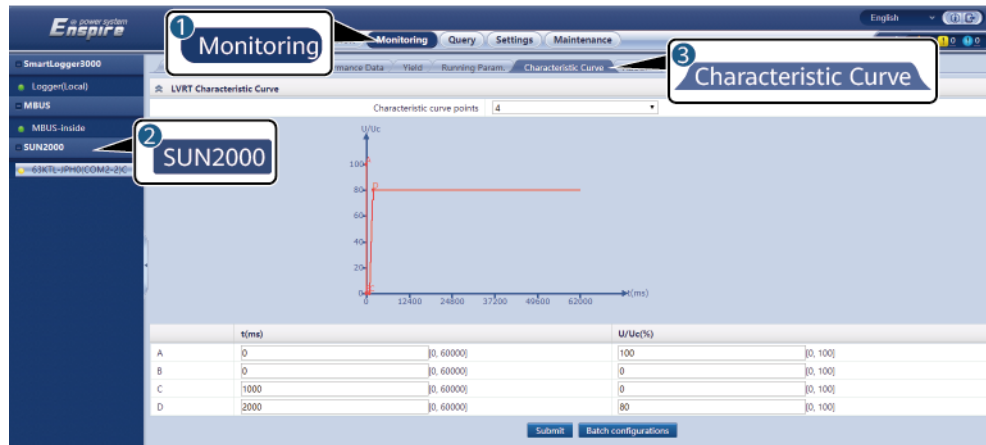

IL04J00026

Characteristic Curve Name	Description
LVRT Characteristic Curve	Configure this characteristic curve based on the power grid standard. NOTE The SmartLogger supports only the 10-second LVRT characteristic curve configuration. If the power grid standard requires that the duration of LVRT be greater than 60s, LVRT Characteristic Curve is not displayed for the grid code.
[Voltage Rise Suppression]Q-U curve	1. Set Voltage Rise Suppression to Enable . 2. Configure this characteristic curve based on the power grid standard.
[Voltage Rise Suppression]P-U curve	1. Set Voltage Rise Suppression to Enable . 2. Configure this characteristic curve based on the power grid standard.

----End

6.3.7 Setting PID Module Parameters

Procedure

Step 1 Set access parameters.

- **Method 1:** Click **Auto. Search** to connect the PID.
- **Method 2:** Click **Add Devices**, set access parameters, and click **Add Devices**.

Figure 6-23 Setting access parameters

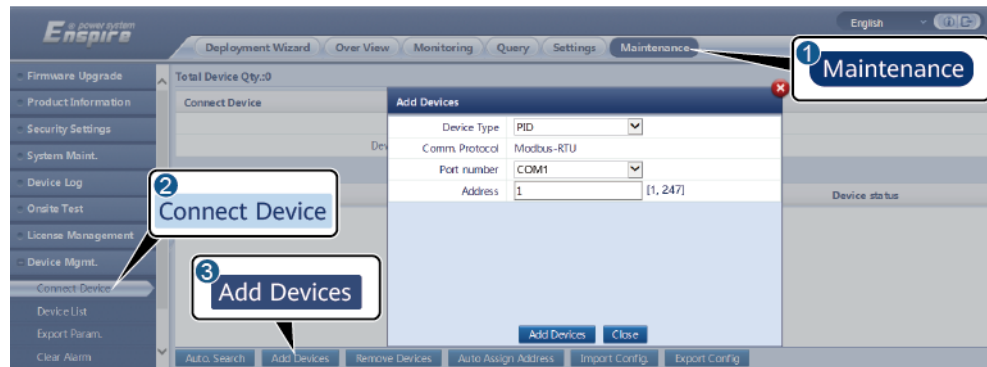

IL03J00017

Parameter	Description
Device Type	Set this parameter to PID .
Port number	<ul style="list-style-type: none"> If the PID-PVBOX uses the MBUS for communication, set this parameter to MBUS. If the PID uses RS485 for communication, set this parameter to the COM port connected to the PID.
Address	Set this parameter to the communications address of the PID.

Step 2 Set running parameters and click **Submit**.

Figure 6-24 Setting running parameters

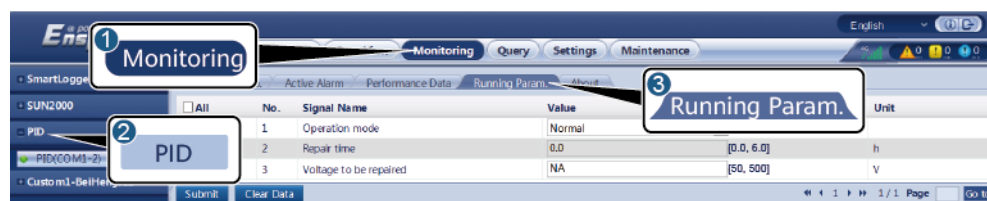

IL03J00018

----End

6.3.7.1 PID Module Running Parameters

NOTE

The parameter list provided in this document includes all configurable parameters. Configurable parameters vary depending on the device model. The actual display prevails.

Parameter	Description
Offset mode	<p>Specifies the offset mode of the PID module.</p> <ul style="list-style-type: none"> • Select Disabled if the PID module is not required. • Select N/PE if the PID module is required to use voltage output from the inductor virtual midpoint. • Select PV/PE if the PID module is required to use voltage output from the negative PV terminal. This mode is applicable only to Huawei SUN8000. • In the SUN2000 scenario, Automatic indicates the N/PE offset mode.
Output enabled	<p>Specifies whether PID module output is enabled.</p>
PV type	<p>Specifies the type of the PV module used in the PV plant. For details about the PV module type, consult the manufacturer.</p>
PV/PE offset voltage	<p>Specifies the DC output voltage when the offset mode is set to PV/PE.</p> <ul style="list-style-type: none"> • If the PV module type is P, set this parameter to P-type. In this case, the output voltage of the PID module is positive. • If the PV module type is N, set this parameter to N-type. In this case, the output voltage of the PID module is negative.
Operation Mode	<p>Specifies the working mode of the PID module.</p> <ul style="list-style-type: none"> • Manual mode: If Offset mode is set to N/PE or PV/PE, and Output enabled is set to Enable, the PID module outputs data based on Output voltage (manual). • Automatic mode: After the PID module and solar inverter communicate with the SmartLogger properly, the PID module automatically runs. <p>NOTE</p> <ul style="list-style-type: none"> • To check whether the PID module functions properly, it is recommended that Operation Mode be set to Manual upon first power-on. • After checking that the PID module functions properly, set Operation Mode to Automatic.
Output voltage (manual)	<p>Specifies the output voltage.</p> <p>NOTE</p> <p>After this parameter is set and the output from the PID module becomes stable, use a multimeter that is set to the DC position to measure the three-phase (A, B, and C) voltages of the power grid to the ground, and check whether the voltages are the same as the configured values.</p>
Maximum system DC-to-ground withstand voltage	<p>Specifies the PV-PE voltage when the normal operation mode is used.</p> <p>If the PV module type is P, the parameter value indicates the highest DC voltage between PV+ and PE. If the PV module type is N, the parameter value indicates the highest DC voltage between PV- and PE.</p>

Parameter	Description
Maximum output voltage	<p>Specifies the maximum output voltage of the PID module.</p> <p>If the offset mode is PV/PE, the parameter value indicates the highest DC output voltage between PV and PE. If the offset mode is N/PE, the parameter value indicates the highest DC output voltage between N and PE.</p>
IMD access	<p>Specifies whether the PID module and insulation monitor device (IMD) can operate in cycle mode.</p> <p>Only the IMDs of mainstream suppliers such as DOLD and BENDER are supported, and the IMDs must have enabled dry contacts.</p> <p>NOTICE You can set Periodic PID runtime, Periodic IMD runtime, and IMD control dry contact only when IMD access is set to Enable.</p>
Periodic PID runtime	<p>Specifies the operating time segment of the PID module when the PID module and IMD operate in cycle mode.</p> <p>The IMD is shut down when the PID module is operating.</p>
Periodic IMD runtime	<p>Specifies the operating time segment of the IMD when the PID module and IMD operate in cycle mode.</p> <p>The PID module is standby when the IMD is operating.</p>
IMD control dry contact	<p>Specifies the dry contact No. over which the SmartLogger controls the IMD.</p> <p>Set appropriate ports based on the cable connections between the IMD and the SmartLogger.</p>
PV module compensation voltage direction	<p>Specifies the offset direction of the PID module.</p> <ul style="list-style-type: none"> • PV- positive offset refers to raising the voltage between PV- and the ground to above 0 V through voltage compensation. Select PV- positive offset for P-type PV modules or the N-type PV modules that comprise the solar cells whose positive and negative polarities are on different sides. For example, P-type PV modules, HIT, CIS, thin-film PV modules, and CdTe PV modules meet the requirement for PV- positive offset. • PV+ negative offset refers to lowering the voltage between PV + and ground to below 0 V through voltage compensation. Select PV+ negative offset for the N-type PV modules that comprise the solar cells whose positive and negative polarities are on the same side. <p>NOTE When designing a PV plant, the design institute or user should ask the PV module vendor about the direction of voltage compensation for resisting the PID effect.</p>

Parameter	Description
Working mode	<p>Specifies the working mode of the PID module.</p> <ul style="list-style-type: none"> • Manual mode: The PID module provides output based on Output voltage (manual). • Automatic mode: The PID module operates automatically after the PID module, solar inverter, and SmartLogger communicate with each other properly. <p>NOTE</p> <ul style="list-style-type: none"> • To check whether the PID module functions properly, it is recommended that Operation Mode be set to Manual upon first power-on. • After checking that the PID module functions properly, set Operation Mode to Automatic.
Maximum system DC-to-ground withstand voltage	<p>Specifies the voltages between the PV side and PE and between the AC side and ground in normal mode.</p> <p>Specifies the lower thresholds of the maximum voltage ranges between the inverter DC side (including the inverter, PV module, cable, SPD, and switch) and ground in a PV power system.</p> <p>The default value is 1000 V. For the 1500 V inverter, the recommended value is 1500 V.</p>
AC-to-ground resistance alarm threshold	<p>Specifies the alarm threshold for the impedance between the AC side of the PID module and ground.</p> <p>You can set an alarm threshold for the impedance between the AC grid and ground for the PID module. If the detected impedance is below the threshold, the PID module will generate an alarm.</p>

Parameter	Description
Compensation offset voltage	<p>Specifies the compensation offset voltage between PV and PE after the PID module operates stably.</p> <p>The value ranges from 0–500 V, and the default value is 50 V.</p> <ul style="list-style-type: none"> If the PV module compensation voltage direction is set to PV- positive offset, the value indicates the positive voltage between PV- and the ground, and the compensation range is 0–500 V. If PV module compensation voltage direction is set to PV+ negative offset, the value indicates the negative voltage between PV+ and ground, and the compensation –500 V to 0 V. <p>NOTE</p> <ul style="list-style-type: none"> If Compensation offset voltage is set to 500 V, the PID module provides the maximum output to enhance the voltage compensation effect. The output voltage amplitude of the PID module is automatically capped to ensure the safety of a PV power plant. The output voltage amplitude is also related to the maximum system DC-to-ground withstand voltage and maximum output voltage. After this parameter is set and the PID module works properly, use a multimeter that is set to the DC position to measure the voltage between the PV input terminal of the SUN2000 and ground. (For PV- positive offset, check whether the voltage between PV- and ground is greater than or equal to 0 V. For PV+ negative offset, check whether the voltage between PV+ and ground is equal to or less than 0 V.)
Clear data	<p>Clears the active alarms and historical alarms stored on the PID module.</p> <p>You can select Clear data to clear active alarms and historical alarms for the PID module.</p>

6.3.7.2 PID-PVBOX Running Parameters

Parameter	Description
Operation mode	<p>Specifies the current working mode of the PID module.</p> <ul style="list-style-type: none"> Before setting this parameter to Manual, ensure that inverters in a PV array are powered off and their DC switches are turned off. This working mode is used during commissioning after deployment or fault locating. In this case, the PID-PVBOX delivers the output voltage based on the value of the commissioned output voltage. Set this parameter to Automatic after ensuring that the PID module works normally.
Output voltage (manual)	Specifies the output voltage when the PID module works in commissioning mode.
Repair time	Set the recovery time for each day.

Parameter	Description
Voltage to be repaired	Specifies the output voltage when the PID module works in normal mode.

6.3.7.3 PID-SSC Running Parameters

Parameter	Description
Operation mode	<p>Specifies the current working mode of the PID module.</p> <ul style="list-style-type: none"> Set this parameter to Manual during commissioning after deployment or fault locating. In this case, the PID-SSC delivers the output voltage based on the value of the commissioned output voltage. Set this parameter to Automatic after ensuring that the PID module works normally.
Output voltage (manual)	Specifies the output voltage when the PID module works in commissioning mode. It is recommended that Output voltage (manual) be set to a value greater than 250 V.

6.3.8 Setting Power Meter Parameters

6.3.8.1 Setting DL/T645 Power Meter Parameters

Procedure

Step 1 Set access parameters and click **Add Devices**.

Figure 6-25 Setting access parameters

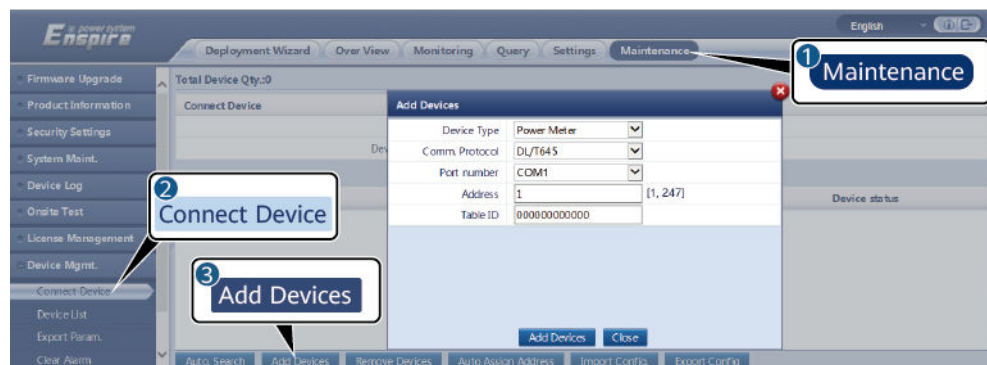

IL03J00019

Parameter	Description
Device Type	Set this parameter to Power Meter .
Comm. Protocol	Set this parameter to DL/T645 .
Port number	Set this parameter to the serial number of the COM port connected to the power meter.
Address	Set this parameter to the communication address of the power meter.
Table ID	Set this parameter to the meter ID.

Step 2 Set running parameters and click **Submit**.

Figure 6-26 Setting running parameters

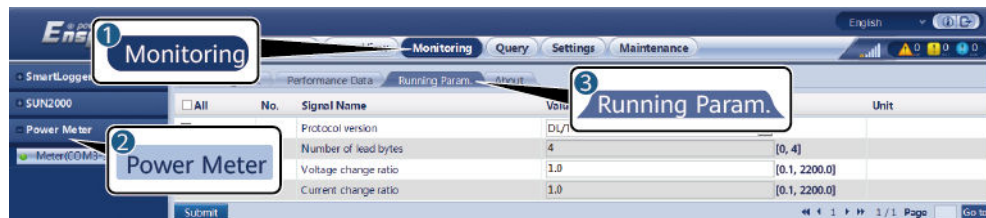

IL03J00020

Parameter	Description
Protocol version	Select DL/T645-2007 or DL/T645-1997 based on the protocol version of the power meter.
Number of lead bytes	Retain the default value unless otherwise specified.
Voltage change ratio	<ul style="list-style-type: none"> Set this parameter to 1 when the power meter uploads a value once. When the power meter uploads a value twice, set this parameter based on the actual transformer ratio.
Current change ratio	

----End

6.3.8.2 Setting Modbus-RTU Power Meter Parameters

Procedure

Step 1 Set power meter parameters and click **Submit**.

Figure 6-27 Setting power meter parameters

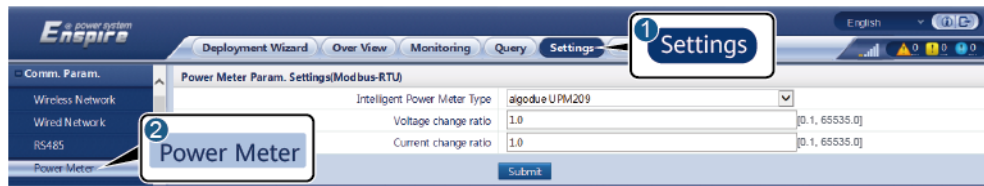

IL03J00021

- If the model of the connected device is displayed in the **Intelligent Power Meter Type** drop-down list box, set parameters as follows.

Parameter	Description
Intelligent Power Meter Type	Set this parameter to the corresponding meter model.
Voltage change ratio	<ul style="list-style-type: none"> • Set this parameter to 1 when the power meter uploads a value once. • When the power meter uploads a value twice, set this parameter based on the actual transformer ratio.
Current change ratio	

- If the connected power meter is of another model, set parameters as follows.

Parameter	Description
Intelligent Power Meter Type	Set this parameter to Other .
Read function code	Set this parameter to Read holding register 03H or Read holding register 04H based on the protocol adopted by the vendor.
Read mode	The value can be Multiple read or Single read .
Word ordering	Set this parameter to Big endian or Little endian based on the protocol adopted by the vendor.
Start address	If Read mode is set to Multiple read , set the start address for reading.
End address	If Read mode is set to Multiple read , set the end address for reading.
Voltage change ratio	<ul style="list-style-type: none"> • Set this parameter to 1 when the power meter uploads a value once. • When the power meter uploads a value twice, set this parameter based on the actual transformer ratio.
Current change ratio	

Parameter	Description
Signal parameters NOTE Signal parameters include Signal Name, Signal address, Number of Registers, Gain, Data Type, and Unit.	Set this parameter based on the vendor protocol. NOTE If the power meter can collect a signal, set Signal address for the signal to the corresponding register address. If the power meter cannot collect a signal, set Signal address for the signal to 65535 .

Step 2 Set access parameters and click **Add Devices**.

Figure 6-28 Setting access parameters

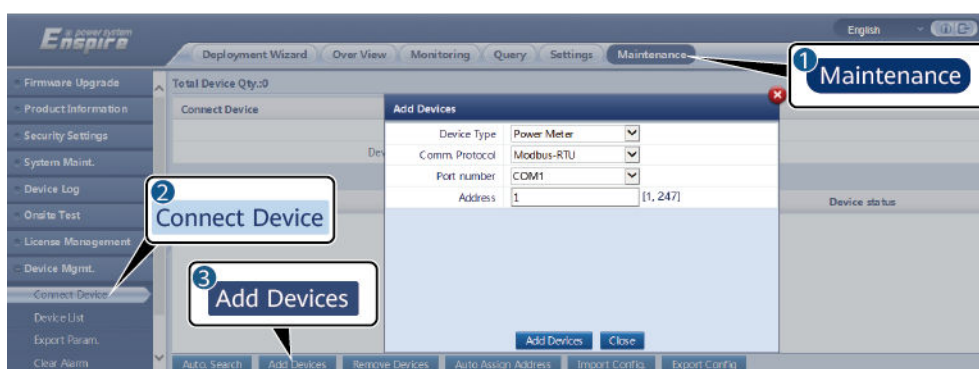

IL03J00022

Parameter	Description
Device Type	Set this parameter to Power Meter .
Comm. Protocol	Set this parameter to Modbus-RTU .
Port number	Set this parameter to the serial number of the COM port connected to the power meter.
Address	Set this parameter to the communication address of the power meter.

----End

6.3.9 Setting EMI Parameters

6.3.9.1 Setting Modbus-RTU EMI Parameters

Procedure

Step 1 Set access parameters and click **Add Devices**.

Figure 6-29 Setting access parameters

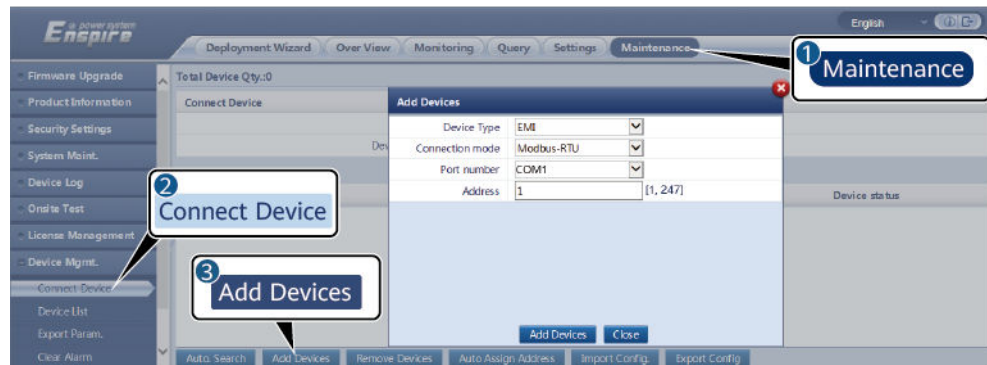

IL03J00023

Parameter	Description
Device Type	Set this parameter to EMI .
Connection mode	Set this parameter to Modbus-RTU .
Port number	Set this parameter to the serial number of the COM port connected to the EMI.
Address	Set this parameter to the communication address of the EMI.

Step 2 Set running parameters and click **Submit**.

Figure 6-30 Setting running parameters



IL03J00024

- If the model of the connected EMI is displayed in the **EMI model** drop-down list box, set parameters as follows.

Parameter	Description
EMI model	Set this parameter to the model of the connected EMI.
Synchronize Environment Data	You are advised to retain the default value Disable . NOTE When this parameter is set to Enable , the SmartLogger transmits the wind speed and direction data to the solar inverter in a PV plant with the tracking system.

Parameter	Description
Master/Slave	When the SmartLogger connects to multiple EMIs, set one of them to master mode . The solar inverter performance data displayed is the data of the EMI in master mode .

- If the connected EMI is a split EMI that supports Modbus-RTU, set parameters as follows.

Parameter	Description
EMI model	Set this parameter to Sensor(ADAM) .
Synchronize Environment Data	You are advised to retain the default value Disable . NOTE When this parameter is set to Enable , the SmartLogger transmits the wind speed and direction data to the solar inverter in a PV plant with the tracking system.
Master/Slave	When the SmartLogger connects to multiple EMIs, set one of them to master mode . The solar inverter performance data displayed is the data of the EMI in master mode .
Read function code	Set this parameter to Read holding register 03H or Read holding register 04H based on the protocol adopted by the vendor.
Data reporting mode	Set this parameter to Integer or Floating point based on the protocol adopted by the vendor.
Word ordering	Set this parameter to Big endian or Little endian based on the protocol adopted by the vendor.
Read mode	The value can be Multiple read or Single read .
Start address	If Read mode is set to Multiple read , set the start address for reading.
End address	If Read mode is set to Multiple read , set the end address for reading.
Signal parameters NOTE Signal parameters include Signal Name , Signal address , Lower Thres. , Upper Thres. , Spec , Start (mV/mA) , End (mV/mA) , and Unit .	Set these parameters based on the vendor protocol. NOTE If the EMI can collect a signal, set Signal address for the signal to the corresponding register address. If the EMI cannot collect a signal, set Signal address for the signal to 65535 .

- If the connected EMI is of another model, set parameters as follows.

Parameter	Description
EMI model	Set this parameter to Other .
Synchronize Environment Data	You are advised to retain the default value Disable . NOTE When this parameter is set to Enable , the SmartLogger transmits the wind speed and direction data to the solar inverter in a PV plant with the tracking system.
Master/Slave	When the SmartLogger connects to multiple EMIs, set one of them to master mode . The solar inverter performance data displayed is the data of the EMI in master mode .
Read function code	Set this parameter to Read holding register 03H or Read holding register 04H based on the protocol adopted by the vendor.
Data reporting mode	Set this parameter to Integer or Floating point based on the protocol adopted by the vendor.
Word ordering	Set this parameter to Big endian or Little endian based on the protocol adopted by the vendor.
Read mode	The value can be Multiple read or Single read .
Start address	If Read mode is set to Multiple read , set the start address for reading.
End address	If Read mode is set to Multiple read , set the end address for reading.
Signal parameters NOTE Signal parameters include Signal Name , Signal address , Gain , Offset , and Unit .	NOTE If the EMI can collect a signal, set Signal address for the signal to the corresponding register address. If the EMI cannot collect a signal, set Signal address for the signal to 65535 .

----End

6.3.9.2 Setting AI EMI Parameters

Procedure

Step 1 Set access parameters and click **Add Devices**.

Figure 6-31 Setting access parameters

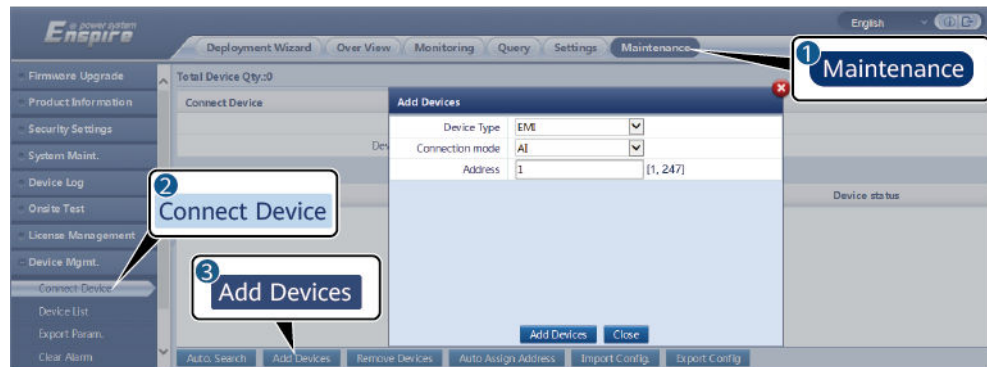

IL03J00025

Parameter	Description
Device Type	Set this parameter to EMI .
Connection mode	Set this parameter to AI .
Address	Set this parameter to the communication address of the EMI.

Step 2 Set running parameters and click **Submit**.

Figure 6-32 Setting running parameters

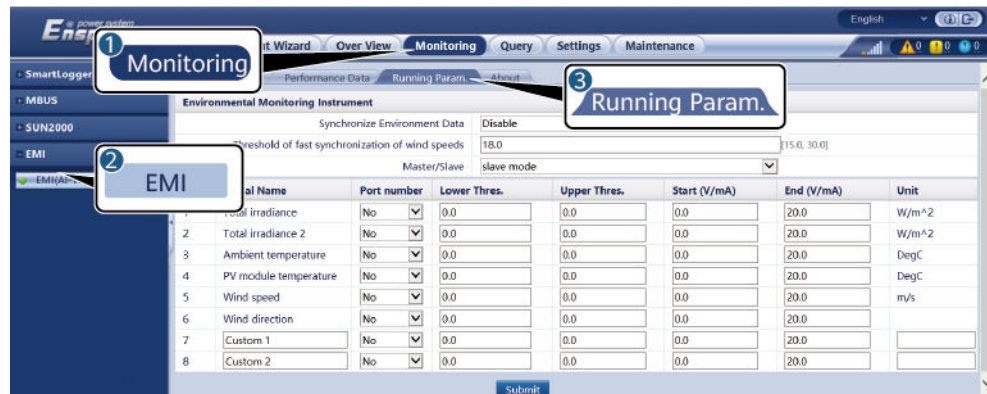

IL03J00026

Parameter	Description
Synchronize Environment Data	You are advised to retain the default value Disable . NOTE When this parameter is set to Enable , the SmartLogger transmits the wind speed and direction data to the solar inverter in a PV plant with the tracking system.

Parameter	Description
Master/Slave	When the SmartLogger connects to multiple EMIs, set one of them to master mode . The solar inverter performance data displayed is the data of the EMI in master mode .
Signal parameters NOTE Signal parameters include Signal Name , Port number , Lower Thres. , Upper Thres. , Start (V/mA) , End (V/mA) , and Unit .	NOTE When you need to change the configured port number, set Port number to No first, then to the required port number.

Step 3 If **Port number** is set to the number of the connected PT port, click **PT T Correction** to correct the temperature.

----End

6.3.10 Setting STS Parameters

Procedure

Step 1 Set access parameters and click **Add Devices**.

Figure 6-33 Setting access parameters

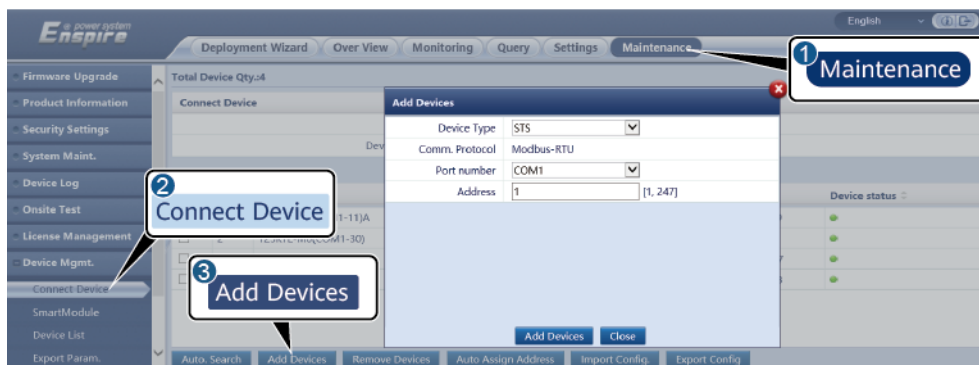

IL04J00006

Parameter	Description
Device Type	Set this parameter to STS .
Port number	Set this parameter to the number of the COM port connected to the STS.
Address	Set this parameter to the communications address of the STS.

Step 2 Set device monitoring parameters and click **Submit**.

Figure 6-34 Device monitoring



IL04J00007

Tab	Function	Description
Teleindication	Views the status parameters of the device, such as the switched-on or switched-off state.	N/A
Telemetry	Views the real-time data of the device, such as the voltage.	N/A
Telecontrol	Sets status control parameters, such as the parameter for controlling switch-on or switch-off.	Set this parameter as required.
Performance Data	Views or exports the performance data of the device.	N/A
Running Param.	Sets the standby signals for teleindication, telemetry, and teleadjust.	Set this parameter as required.
About	Queries communication information.	N/A

Step 3 Choose **Settings > Other Parameters** and set **STS overtemperature protection** as required.

----End

6.3.11 Setting IEC103 Device Parameters

Description

An IEC103 device supports two data transmission modes:

- **Transparent transmission mode:** When connecting to the management system, the SmartLogger transparently transmits the IEC103 device information to the management system. The SmartLogger does not parse the IEC103 device data.

- **Parsing mode:** The IEC103 device is connected to the SmartLogger, and the SmartLogger parses the IEC103 device data.

Transparent Transmission Mode

Step 1 Set IEC103 parameters and click **Submit**.

Figure 6-35 Setting IEC103 parameters

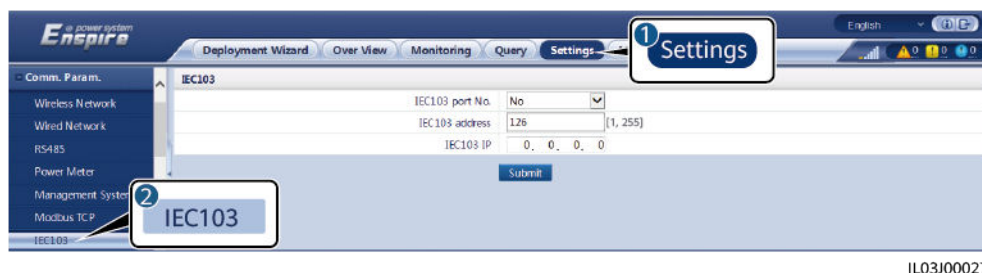

Parameter	Description
IEC103 port No.	Set this parameter based on the COM port connected to the device.
IEC103 address	Set this parameter to the IEC103 device address.
IEC103 IP	Set this parameter to the IP address of the management system.

Step 2 Choose **Settings > Other Parameters** and check that **Data forwarding** is set to **Enable**.

NOTICE

- If **Data forwarding** is set to **Enable**, the SmartLogger transparently transmits information about unconnected devices to the management system without parsing device data.
- If **Data forwarding** is set to **Disable**, the SmartLogger does not transmit information about unconnected devices to the management system.

----End

Parsing Mode

The SmartLogger can connect to third-party devices that support IEC103, such as the relay protection or monitoring device like the transformer substation. The protocol information points vary depending on vendors. Therefore, you need to obtain a protocol information file in **.cfg** format from Huawei and import the file into the SmartLogger for successfully connecting to a custom device.

The supported device types are IEC103 device 1 to IEC103 device 5. The corresponding configuration file names are **iec103_equip_custom_1.cfg** to **iec103_equip_custom_5.cfg**. Multiple devices of the same type can be connected.

Step 1 Configure a protocol information point file in **.cfg** format and import the file to the SmartLogger.

Figure 6-36 Importing configuration

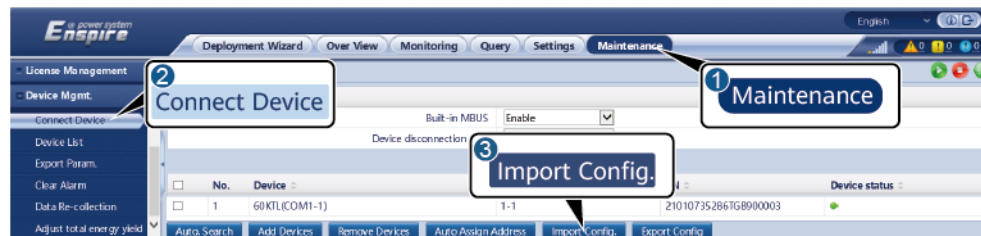

IL03J00028

Step 2 Set access parameters and click **Add Devices**.

Figure 6-37 Setting access parameters

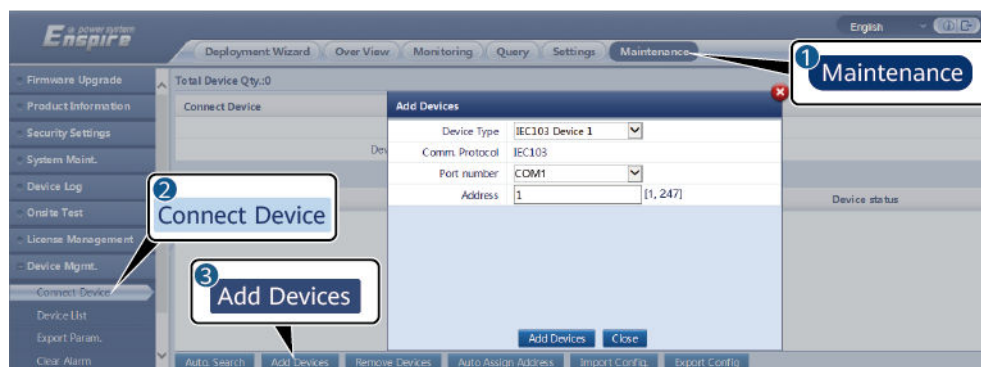

IL03J00029

Parameter	Description
Device Type	The value can be IEC103 Device 1 to IEC103 Device 5 . Select a value based on the configuration file. For example, if iec103_equip_custom_1.cfg needs to be imported, select IEC103 Device 1 .
Port number	Set this parameter to the COM port connected to the IEC103 device.
Address	Set this parameter to the communication address of the IEC103 device.

Step 3 Set device monitoring parameters and click **Submit**.

Figure 6-38 Device monitoring



IL03J00030

Tab	Function	Description
Running Info.	View the running information about the IEC103 device.	N/A
Teleindication	View the device status, such as the switch status.	N/A
Telemetry	View the real-time analog data of the device, such as the voltage.	N/A
Telecontrol	Set the status control parameters, such as the parameters for turning on or off switches.	Set the parameters on the tab page as required.
Teleadjust	Set analog parameters, for example, set voltage protection parameters.	Set the parameters on the tab page as required.

----End

6.3.12 Setting Parameters for a Custom Device

Context

The SmartLogger can connect to third-party devices supporting the Modbus-RTU protocol, such as the transformer substation and EMI. The protocol information points vary depending on vendors. Therefore, you need to configure a protocol information file in **.cfg** format and import the file into the SmartLogger for successfully connecting to a custom device.

The supported device types are custom device 1 to custom device 10. The corresponding configuration file names are **modbus_equip_custom_1.cfg** to **modbus_equip_custom_10.cfg**. Multiple devices of the same type can be connected.

Procedure

- Step 1** Configure a protocol information point file in **.cfg** format and import the file to the SmartLogger.

Figure 6-39 Importing configuration



IL03J00028

- Step 2** Set access parameters and click **Add Devices**.

Figure 6-40 Setting access parameters

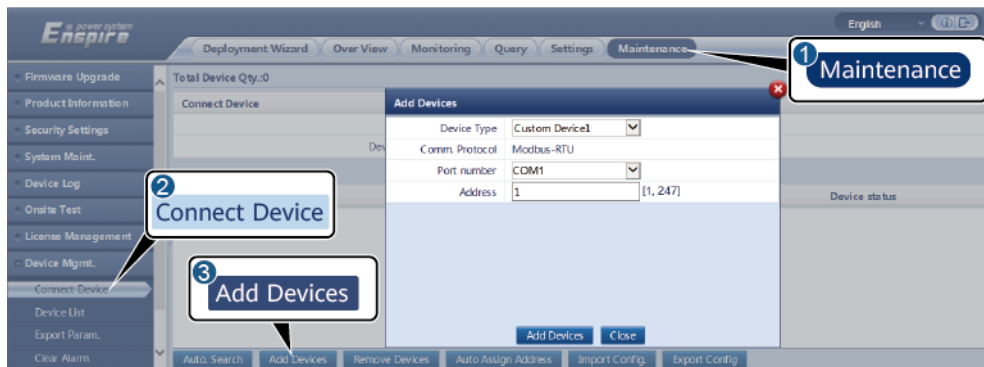

IL03J00031

Parameter	Description
Device Type	The value can be Custom Device 1 to Custom Device 10 . Select a value based on the imported configuration file. For example, if modbus_equip_custom_1.cfg is imported, select Custom Device 1 .
Port number	Set this parameter to the number of the COM port connected to the custom device.
Address	Set this parameter to the communications address of the custom device.

- Step 3** Set device monitoring parameters and click **Submit**.

Figure 6-41 Device monitoring

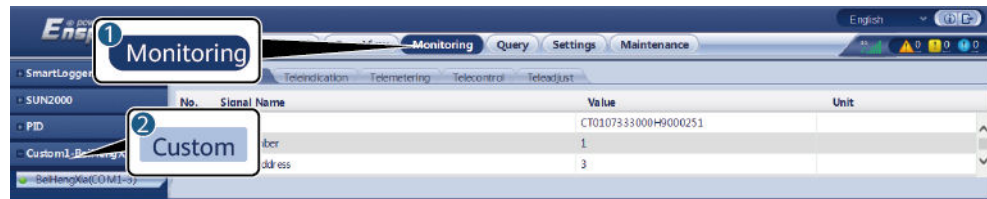

IL03J00032

Tab	Function	Description
Running Info.	View the running information about the custom device.	N/A
Teleindication	View the device status, such as the switch status.	N/A
Telemetry	View the real-time analog data of the device, such as the voltage.	N/A
Telecontrol	Set the status control parameters, such as the parameters for turning on or off switches.	Set the parameters on the tab page as required.
Teleadjust	Set analog parameters, for example, set voltage protection parameters.	Set the parameters on the tab page as required.

----End

6.3.13 Setting IEC104 Device Parameters

Context

The SmartLogger can connect to third-party devices that support IEC104, such as the relay protection or monitoring device like the transformer substation. Protocol information points vary with vendors. Therefore, you need to configure a protocol information point file in .cfg format and import the file to the SmartLogger for connecting to a third-party device.

The supported device types are IEC104 device 1 to IEC104 device 5. The corresponding configuration file names are **iec104_equip_custom_1.cfg** to **iec104_equip_custom_5.cfg**. Multiple devices of the same type can be connected.

Procedure

- Step 1** Configure a protocol information point file in .cfg format and import the file to the SmartLogger.

Figure 6-42 Importing configuration



IL03J00028

Step 2 Set access parameters and click **Add Devices**.

Figure 6-43 Setting access parameters

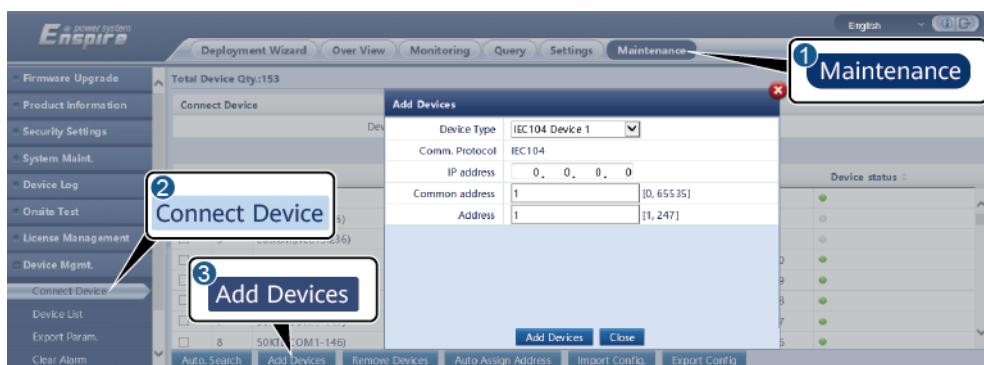

IL04J00012

Parameter	Description
Device Type	The value can be IEC104 Device 1 to IEC104 Device 5 . Select a value based on the imported configuration file. For example, if <code>iec104_equip_custom_1.cfg</code> is imported, select IEC104 Device 1 .
IP address	Set this parameter to the IP address of the IEC104 device.
Common address	Set this parameter to the common address of the IEC104 device.
Address	Set this parameter to the communications address of the IEC104 device.

Step 3 Set device monitoring parameters and click **Submit**.

Figure 6-44 Device monitoring

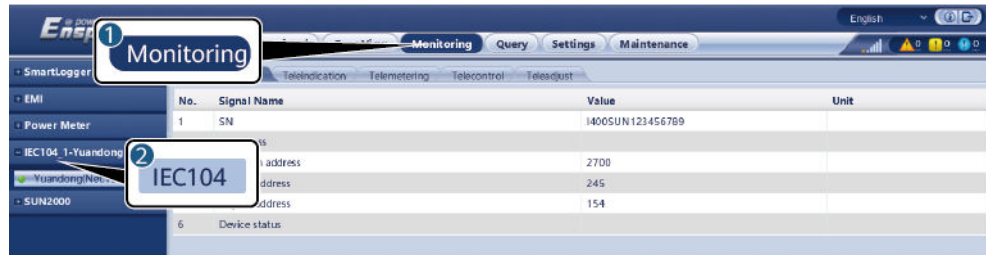

IL04J00013

Tab	Function	Description
Running Info.	View the running information about the custom device.	N/A
Teleindication	View the device status, such as the switch status.	N/A
Telemetry	View the real-time analog data of the device, such as the voltage.	N/A
Telecontrol	Set the status control parameters, such as the parameters for turning on or off switches.	Set the parameters on the tab page as required.
Teledjust	Set analog parameters, for example, set voltage protection parameters.	Set the parameters on the tab page as required.

----End

6.3.14 Sets the parameters related to the poverty alleviation monitoring center.

Context

The SmartLogger can be connected to the poverty alleviation monitoring center in either of the following modes:

- Method 1: The SmartLogger connects to the poverty alleviation monitoring center through the FusionSolar hosting cloud. Method 1 (recommended): Use the FusionSolar hosting cloud to import the PV plant information configuration package provided by the poverty alleviation monitoring center to the SmartLogger.
- Method 2: The SmartLogger directly connects to the poverty alleviation monitoring center. Method 2: Based on the PV plant information configuration package provided by the poverty alleviation monitoring center,

choose **Settings > Poverty Alleviation Monitoring Center** and set the parameters of the SmartLogger poverty alleviation monitoring center. Internet Explorer 8 is used as an example.

Procedure

Step 1 Set parameters for the poverty alleviation monitoring center and click Submit.

Figure 6-45 Poverty alleviation monitoring center



IL03J00019

Parameter		Setting Description
Basic Information	Server	Set this parameter to the address of the poverty alleviation monitoring center server.
	Port	Set this parameter to the port number of the poverty alleviation monitoring center server.
	User Name	Configure the power station information package based on the power station information provided by the poverty alleviation monitoring center.
	Password	
	Device SN:	
	PV plant ID	
This object indicates the name of a CA certificate file.		
Forwarding table	Solar inverter	

----End

6.4 Power Grid Scheduling

6.4.1 Power Adjustment Description

According to standard requirements, the SmartLogger can reliably adjust power for the connected solar inverters in real time to ensure that the PV plant can respond to requirements of the power grid company in a timely manner.

NOTICE

- To ensure that the SmartLogger will deliver scheduling commands to the connected solar inverters, you must select the active or reactive power control mode before adjusting the active or reactive power for a PV plant.
- If **Active power control mode** is set to **No limit** or **Reactive power control mode** is set to **No output**, the SmartLogger does not send scheduling commands to the connected solar inverters.

6.4.2 Setting Active Power Control

If the PV plant has requirements of power limitation, the power grid scheduling personnel should limit the active power or disable all the active power for the PV plant, that is, to enable the active power derating mode.

Step 1 Choose **Monitoring > SUN2000 > Running Param. > Power Adjustment**. On the displayed page, check that **Remote power schedule** is set to **Enable**.

Step 2 Set the parameters for active power control and click **Submit**.

Figure 6-46 Active power control

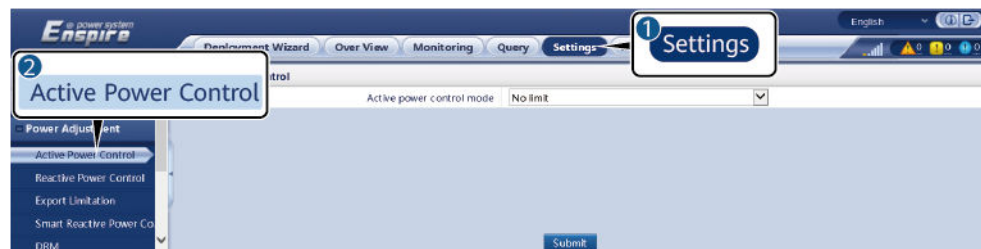

IL04J00008

----End

No Limit

Parameter	Description
Active power control mode	Set this parameter to No limit for the solar inverter to run at full load.

DI Active Scheduling

1. Set DI active scheduling parameters and click **Submit**.

Figure 6-47 DI active scheduling

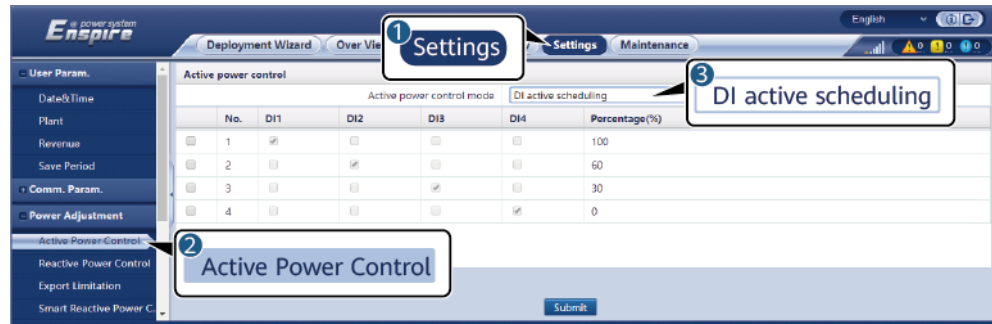

IL04J00027

NOTICE

- When setting this function, ensure that the user-defined DI port is not occupied. Otherwise, the setting will fail.
- When setting this function, ensure that the SmartLogger is correctly connected to a ripple control receiver. (In Germany and some other European areas, a Ripple Control Receiver is used to convert a power grid scheduling signal to a dry contact signal, in which a dry contact is needed.)

Parameter	Description
Active power control mode	Set this parameter to DI active scheduling .
DI NOTE DI parameters include DI1, DI2, DI3, DI4, and Percentage(%) .	<ul style="list-style-type: none"> • Sixteen levels are supported for the active power derating percentage. • "√" indicates a low level. When the four DI ports of the SmartLogger are connected, the ports are low-level ports. When not connected, the ports are high-level ports. • The percentage levels of DI1–DI4 should differ from each other. Otherwise, an abnormal command will be generated. • If the actual input DI signal is inconsistent with that configured on the WebUI, the SmartLogger controls the solar inverter to work at full load and the Abnormal Active Schedule alarm is raised.

Percentage Fixed-Value Limitation (Open Loop)

The SmartLogger provides simplified active power percentage configuration as well as power control automation, that is, to automatically adjust the active power derating percentage in different periods of a day.

Parameter	Description
Active power control mode	Set this parameter to Percentage fixed-value limitation (open loop) to control the maximum output power of the solar inverter by time segment.
Start time	If the solar inverter needs to run with specified maximum power in certain periods of a day, add setting records based on site requirements. When multiple time points are set, the solar inverter will run with the maximum power specified for the time point that is earlier than and the closest to the current system time. For example, if you add 00:00:00 and 12:00:00 on the WebUI and the current system current is 14:30:00, the solar inverter will run with the maximum power specified for 12:00:00.
Percentage(%)	

Remote Communication Scheduling

The management system or independent power adjustment device sends scheduling commands over the communications port that works with Modbus-TCP or IEC104, without the need of user configuration or operation. The SmartLogger can automatically switch between scheduling modes and send scheduling commands.

Parameter	Description
Active power control mode	Set this parameter to Remote communication scheduling . The SmartLogger parses the scheduling command delivered by the upper-layer management system to valid instruction data that can be identified by the solar inverters in the PV plant and delivers the data to all solar inverters connected to the SmartLogger. As the Remote communication scheduling mode has a higher priority, the SmartLogger automatically changes Active power control mode to Remote communication scheduling after receiving a scheduling command from the upper-layer management system.

Parameter	Description
Schedule strategy	<p>The value can be Disable, Strategy 1, or Strategy 2.</p> <ul style="list-style-type: none">• Disable: The SmartLogger controls the solar inverter to work at full load and will not receive scheduling commands sent by the management system.• Strategy 1: Open-loop scheduling policy. That is, the SmartLogger evenly allocates the power value from the scheduling and delivers the average value to each solar inverter, which then operates with the specific power. The adjustment value delivered by the SmartLogger is constant. If Adjustment coefficient is set, the power value will be sent to the solar inverter after being multiplied by the preset coefficient.• Strategy 2: The customized function is provided for a specific power plant. Set Overshoot, Adjustment period, and Adjustment deadband based on the scheduling requirements of the power plant.<ul style="list-style-type: none">– Overshoot: Indicates the maximum overshoot percentage during adjustment. If a PV plant cannot reach the preset target value due to factors such as insufficient sunlight, the set target value is the current value plus the overshoot.– Adjustment period: Indicates the time required from adjustment instruction delivery, solar inverter response to the instruction, to the detection of the preceding actions by the SmartLogger.– Adjustment deadband: Indicates the percentage of the adjustment deviation value to the rated output capacity. In the adjustment deadband, strategy 2 does not deliver control instructions but still detects the deviation in real time.
Shutdown upon communication exceptions	<p>If this parameter is set to Enable, the SmartLogger shuts down solar inverters when the communication between the SmartLogger and the scheduling background is interrupted and the duration of communication interruption exceeds the value specified by Time for communication exception detection.</p>

Parameter	Description
Time for communication exception detection	If the duration of communication interruption between the SmartLogger and the scheduling background exceeds the value specified by Time for communication exception detection , the communication between the SmartLogger and the scheduling background is abnormal.
Automatic startup upon communication recovery	Allows a solar inverter to be automatically started if the communication recovers after an exception.

Grid connection with limited power (kW)

NOTICE

- You are advised to choose **Settings > Grid connection with limited power** and enable the grid connection with limited power function.
- To enable this function, you need to set power meter, inverter, and grid connection with limited power parameters. This section describes how to set grid connection with limited power parameters.
- Before setting the parameters, ensure that a power meter has been connected to the SmartLogger.

Step 1 Set export limitation parameters and click **Submit**.

Parameter	Description
Active power control mode	Set this parameter to Grid connection with limited power (kW) .
Power meter	Set this parameter to Smart meter . Otherwise, the function will not take effect.
Electric meter power direction	When the inverter has no output power, set this parameter to Positive if the active power reading of the power meter is positive. Otherwise, set this parameter to Reverse .
Limitation mode	<ul style="list-style-type: none"> • Total power: controls the total power at the grid-tied point to limit the power fed to the power grid. • Single-phase power: controls the power of each phase at the grid-tied point to limit the power fed to the power grid.

Parameter	Description
Maximum grid feed-in power	Indicates the maximum power that the inverter can feed into the power grid. Suggestion: Set this parameter based on the export limitation threshold allowed by the power grid company.
Power lowering adjustment period	Specifies the period for lowering the inverter output power.
Maximum protection time	Specifies the maximum duration from the time when the SmartLogger detects backflow to the time when the inverter output power reaches 0. Suggestion: Set this parameter based on the maximum backflow duration allowed by the power grid company.
Power raising threshold	Specifies the threshold for raising the inverter output power.
Fail-safe power threshold	Inverter output power percentage is controlled by the SmartLogger when communication between the SmartLogger and the power meter is abnormal.
Switch-off with 0% power limit	Specifies whether the DO port is allowed to control switch-off.
Switch-off control port	Set this parameter to the DO port that controls switch-off.
Switch-on control port	Set this parameter to the DO port that controls switch-on.
Switch-off state feedback port	Set this parameter to the DI port that reports the switch-off status.
Switch-on state feedback port	Set this parameter to the DI port that reports the switch-on status.

Step 2 Verify that the SmartLogger can remotely turn on and off circuit breakers in scenarios with circuit breakers.

- Click **Switch off** and check that the circuit breaker is switched off properly.
- Click **Switch on** and check that the circuit breaker is switched on properly.

----End

Remote Output Control

Step 1 Synchronize the clock source of the server.

Path	Parameter	Description
Settings > User Param. > Date&Time	Clock source	Set this parameter to NTP .
	Server	Set this parameter to the IP address or domain name of the server for time synchronization.
	NTP synchronization test	You can click this button to check the time synchronization status.

Step 2 Set remote output control parameters.

Path	Parameter	Description
Settings > Active Power Control	Active power control mode	Set this parameter to Remote output control .
	Control area	Set this parameter to the area where the remote output control function is used. To enable the function in some areas, the license needs to be imported and enabled.
	Output control duration	Set this parameter to the time required for the solar inverter to change its output power from 0% to 100% or from 100% to 0%.
	PV plant ID	Set this parameter to the PV plant ID.
	Remote output control server	Set this parameter to the IP address or domain name of the server.
	Enable certificate	Determine whether to import and enable a certificate based on the actual situation.
	PV module capacity	Set this parameter to the capacity of PV modules connected to the PV plant.
	Plant AC capacity	Set this parameter to the AC capacity of the restricted power that is fed into the power grid from the PV plant.

 **NOTE**

- If the connection between the SmartLogger and the server is abnormal, obtain the output control file in .data format from the website of the power company and import the file.
- After the SmartLogger connects to the server, you can export the relevant file.

----End

6.4.3 Setting Reactive Power Control

Large-scale PV plants are required to adjust the voltage at the grid-tied point. Power grid scheduling personnel enable a PV plant to absorb or add reactive power at the grid-tied point, that is, to enable the reactive power compensation, based on the real-time reactive power transmission status in the power grid.

- Step 1** Choose **Monitoring > SUN2000 > Running Param. > Power Adjustment**. On the displayed page, check that **Remote power schedule** is set to **Enable**.
- Step 2** Set the parameters for reactive power control and click **Submit**.

Figure 6-48 Reactive power control



IL04J00009

----End

No Output

Parameter	Description
Reactive power control mode	If the PV plant is not required to adjust the voltage at the grid-tied point or perform reactive power compensation, solar inverters can run with pure active power output. In this case, set this parameter to No output .

DI Reactive Scheduling

- 1. Set DI reactive scheduling parameters and click **Submit**.

Figure 6-49 DI reactive scheduling



IL04J00028

NOTICE

- When setting this function, ensure that the user-defined DI port is not occupied. Otherwise, the setting will fail.
- SmartLogger scenario: Before setting this function, ensure that the SmartLogger is properly connected to the Ripple Control Receiver.
- SmartLogger+SmartModule scenario: Before setting this function, ensure that the SmartModule is properly connected to the Ripple Control Receiver.

Table 6-5 SmartLogger scenario

Parameter	Description
Reactive power control mode	Set this parameter to DI reactive scheduling .
DI NOTE DI parameters include DI1, DI2, DI3, DI4, and Power factor .	<ul style="list-style-type: none"> • Sixteen levels are supported for power factors. • "√" indicates a low level. When the four DI ports of the SmartLogger are connected, the ports are low-level ports. When not connected, the ports are high-level ports. • The percentage levels of DI1–DI4 should differ from each other. Otherwise, an abnormal command is generated. • If the actual input DI signal is inconsistent with that configured on the WebUI, the SmartLogger controls the solar inverter to work at full power and the Abnormal Reactive Schedule alarm is raised.

Table 6-6 SmartLogger+SmartModule scenario

Parameter	Description
Reactive power control mode	Set this parameter to DI reactive scheduling .
DI NOTE The DI parameters include M1.DI1, M1.DI2, M1.DI3, M1.DI4, and Percentage(%) .	<ul style="list-style-type: none"> • Supports 16 levels of percentages. • "√" indicates a low level. When the four DI ports of the SmartModule are connected, the ports are low-level ports. When not connected, the ports are high-level ports. • The percentage levels of M1.DI1 to M1.DI4 should differ from each other. Otherwise, an exception will occur during command parsing. If the actual input DI signal is inconsistent with that configured on the WebUI, the SmartLogger controls the solar inverters to work at full load and generates the Abnormal Reactive Schedule alarm.

 NOTE

- Before connecting the SmartModule to the SmartLogger, if **DI reactive scheduling** has been configured for the DI port and the scheduling signal needs to be connected to the SmartModule, delete the DI configuration and reconfigure it.
- In the scenario where the SmartLogger and SmartModule are combined, if the SmartModule is removed and the scheduling signal needs to be connected to the SmartLogger, delete the DI configuration and reconfigure it.

Reactive Power Fix Control

Parameter	Description
Reactive power control mode	If the PV array is required to generate constant reactive power at a specified time, set this parameter to Reactive power fix control .
Start time	If the solar inverter is required to run with specified maximum power in certain periods of a day, add setting records based on site requirements. When multiple time points are set, the solar inverter will run with the maximum power specified for the time point that is earlier than and the closest to the current system time. For example, if you add 00:00:00 and 12:00:00 on the WebUI and the current system current is 14:30:00, the solar inverter will run with the maximum power specified for 12:00:00.
Reactive power (kVar)	

Power Factor Fix Control

Parameter	Description
Reactive power control mode	If the PV plant is required to generate a constant power factor at the grid-tied point and the solar inverter is required to adjust the real-time reactive power based on the preset power factor, set this parameter to Power factor fix control .
Start time	If the solar inverter is required to run with a specified power factor in certain periods of a day, add setting records based on site requirements. When multiple time points are set, the solar inverter will run with the maximum power specified for the time point that is earlier than and the closest to the current system time. For example, if you add 00:00:00 and 12:00:00 on the WebUI and the current system current is 14:30:00, the solar inverter will run with the maximum power specified for 12:00:00.
Power factor	

Q-U Characteristic Curve

If you do not need the SmartLogger to send remote reactive power control commands, you can configure the characteristic curve as a substitute. The SmartLogger delivers the values configured for the characteristic curve to the solar inverter, which then operates according to the configuration. The SmartLogger no longer adjusts the values.

NOTICE

Configure the characteristic curve under instructions from professionals to ensure that the solar inverter works properly.

The Q-U characteristic curve control mode is to dynamically adjust the ratio Q/S of output reactive power to apparent power in accordance with the ratio U/Un(%) of the actual grid voltage to the rated grid voltage.

Parameter	Description
Reactive power control mode	Set this parameter to Q-U characteristic curve .
Reactive power adjustment time	Specifies the change interval of the reactive power for a grid-tied point.
Trigger power ratio	Under a specific grid code, after you set this parameter, the characteristic curve takes effect only when the actual output active power of the solar inverter is greater than the preset value.
Characteristic curve points	Specifies the number of characteristic curve points. The characteristic curve supports a maximum of 10 valid points.
U/Un(%)	When configuring the curve, ensure that the U/Un(%) value of a point is greater than the U/Un(%) value of the previous point. Otherwise, the message indicating invalid input will be displayed.
Q/S	

cosφ-P/Pn Characteristic Curve

If you do not need the SmartLogger to send remote reactive power control commands, you can configure the characteristic curve as a substitute. The SmartLogger delivers the values configured for the characteristic curve to the solar inverter, which then operates according to the configuration. The SmartLogger no longer adjusts the values.

NOTICE

Configure the characteristic curve under instructions from professionals to ensure that the solar inverter works properly.

The $\cos\phi$ -P/Pn characteristic curve control mode is to dynamically adjust the power factor $\cos\phi$ in accordance with the P/Pn (%) based on the VDE-4105 and BDEW German standards.

Parameter	Description
Reactive power control mode	Set this parameter to $\cos\phi$-P/Pn characteristic curve .
Characteristic curve points	Specifies the number of characteristic curve points. The characteristic curve supports a maximum of 10 valid points.
U/Un(%) $\cos\phi$	When configuring the curve, ensure that the P/Pn(%) value of a point is greater than the P/Pn(%) value of the previous point. Otherwise, the message indicating invalid input will be displayed.

Q-U Hysteresis Curve (CEI0-16)

If you do not need the SmartLogger to send remote reactive power control commands, you can configure the characteristic curve as a substitute. The SmartLogger delivers the values configured for the characteristic curve to the solar inverter, which then operates according to the configuration. The SmartLogger no longer adjusts the values.

NOTICE

Configure the characteristic curve under instructions from professionals to ensure that the solar inverter works properly.

The Q-U hysteresis curve (CEI0-16) control mode is the Italian standard CEI0-16 version of the Q-U characteristic curve. It dynamically adjusts the output reactive power of the solar inverter in accordance with the ratio of the actual voltage to the rated voltage. The final value should be in the form of Q/S.

Parameter	Description
Reactive power control mode	Set this parameter to Q-U hysteresis curve(CEI0-16) .
Reactive power adjustment time	Specifies the change interval of the reactive power for a grid-tied point.
Percents of trigger frequency	Under a specific grid code, after you set this parameter, the characteristic curve takes effect only when the actual output active power of the solar inverter is greater than the preset value.
U/Un(%)	When configuring the curve, ensure that the U/Un(%) value of a point is greater than the U/Un(%) value of

Parameter	Description
Q/S	the previous point. Otherwise, the message indicating invalid input will be displayed. When configuring the curve, ensure that the Q/S values at points A and B are the same and set in sequence, and that the Q/S values at points C and D are the same and set in sequence. Otherwise, a message indicating invalid input is displayed.

Remote Communication Scheduling

The management system or independent power adjustment device sends scheduling commands over the communications port that works with Modbus-TCP or IEC104, without the need of user configuration or operation. The SmartLogger can automatically switch between scheduling modes and send scheduling commands.

Parameter	Description
Reactive power control mode	As the Remote communication scheduling mode has a higher priority, the SmartLogger automatically changes Reactive power control mode to Remote communication scheduling after receiving a scheduling command from the upper-layer management system. If this parameter is set to Remote communication scheduling , the SmartLogger parses the scheduling command delivered by the upper-layer management system to valid instruction data that can be identified by the solar inverters in the PV plant and delivers the data to all solar inverters connected to the SmartLogger.

Power Factor Closed-Loop Control (Old Policy)

NOTICE

Before setting this parameter, ensure that the power meter is correctly connected to the SmartLogger.

Parameter	Description
Reactive power control mode	Set this parameter to Power factor closed-loop control (old policy) .

Parameter	Description
Target power factor	Specifies the target value for the adjustment power factor of the power meter.
Adjustment period	Specifies the interval for sending adjustment commands by the SmartLogger.
Adjustment deadband	Specifies the adjustment power factor precision. NOTICE This parameter is valid only when the power factor of the power meter is greater than 0.9.

Power Factor Closed-Loop Control

To improve the revenue, a distributed PV plant needs to reduce or avoid the power factor surcharge by performing distributed reactive power compensation. To enable the function, set the related parameters.

NOTICE

- You are advised to choose **Settings > Smart Reactive Power Compensation** to enable smart reactive power compensation.
- Before setting the parameters, ensure that the license for smart reactive power compensation has been loaded on the **Maintenance > License Management** page.
- Before setting the parameters, ensure that a power meter has been connected to the SmartLogger.

Parameter	Description
Reactive power control mode	Set this parameter to Power factor closed-loop control .
Electric meter power direction	When the solar inverter has no output power, set this parameter to Positive if the active power displayed on the meter is positive. Otherwise, set this parameter to Reverse . After the setting is complete, you can check the power direction of the power meter if you are not sure about it.
Power meter	Set this parameter to Smart meter .
Target power factor	Specifies the target value for the adjustment power factor of the power meter. The target value should be larger than the appraisal value of the PV plant power factor.
Adjustment period	Specifies the interval for sending adjustment commands by the SmartLogger.

Parameter	Description
Adjustment deadband	Specifies the adjustment power factor precision. NOTICE This parameter is valid only when the power factor of the power meter is greater than 0.9.
Reactive compensation delay	Specifies the delay time for starting the distributed power factor compensation if the current power factor is lower than the target power factor.

NOTICE

When the SmartLogger receives a remote reactive power scheduling command from the PV plant, it automatically changes **Reactive power control mode** to **Remote communication scheduling**. If power factor closed-loop control is required, set **Reactive power control mode** to **Power factor closed-loop control** and set the target power factor correctly.

6.4.4 Setting Export Limitation Parameters

Context

When the PV plant generates power for self-consumption, countercurrent may feed into the power grid if the loads cannot consume all the power. In this case, you can set the export limitation parameters over the WebUI to prevent countercurrent.

- Scenario without a circuit breaker: The countercurrent feeding into the power grid can be eliminated by sending a command from the SmartLogger to lower the solar inverter output power.

Figure 6-50 Network diagram (without a circuit breaker)

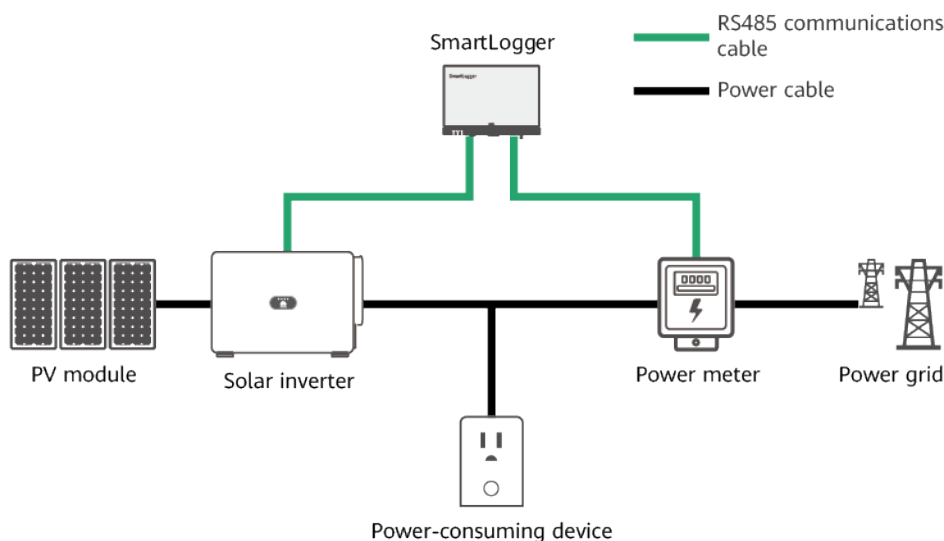

IL04P00002

- Scenario with a circuit breaker: If the countercurrent feeding into the power grid cannot be eliminated by sending a command from the SmartLogger to lower the solar inverter output power, and **Maximum protection time** is exceeded, the SmartLogger drives the relay to switch off the circuit breaker by controlling the DO port to prevent countercurrent. When the DI port detects that the circuit breaker is switched off, the DO port of the SmartLogger and the relay will be switched off, and the SmartLogger will restore to the initial state.

NOTE

Connect the DO ports in series to the 12 V power supply loop of the relay coils. You are advised to use the 12 V power output port on the SmartLogger to power the relay coils. You can also prepare a 12 V power supply.

Figure 6-51 Network diagram (with a circuit breaker)

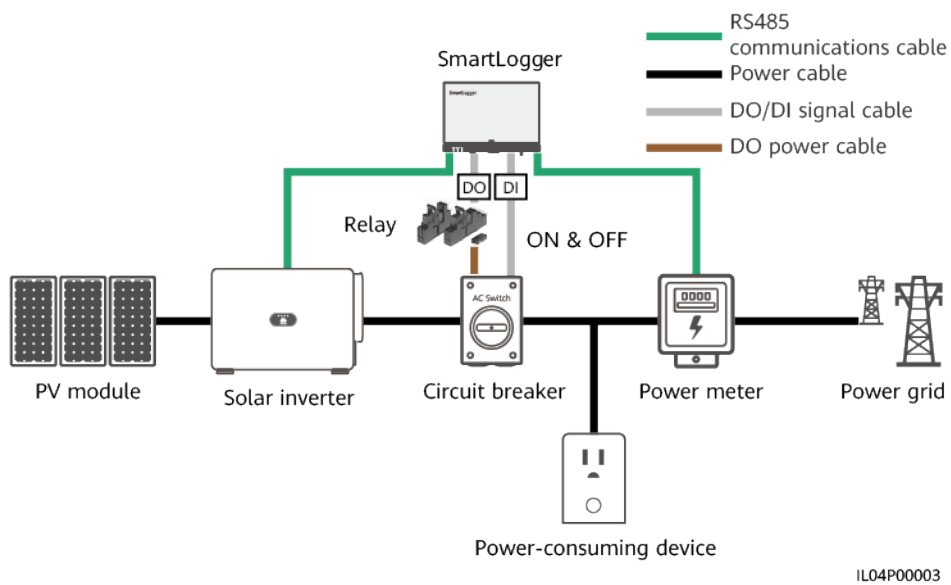

CAUTION

In the scenario with a circuit breaker, place the power supply of the SmartLogger before the circuit breaker to avoid the SmartLogger power-off after the DO switches off the circuit breaker.

Procedure

- Step 1** Set parameters as prompted. For details, click **Help** on the page.

NOTE

Click **Previous** and **Next** as required.

Figure 6-52 Setting export limitation parameters

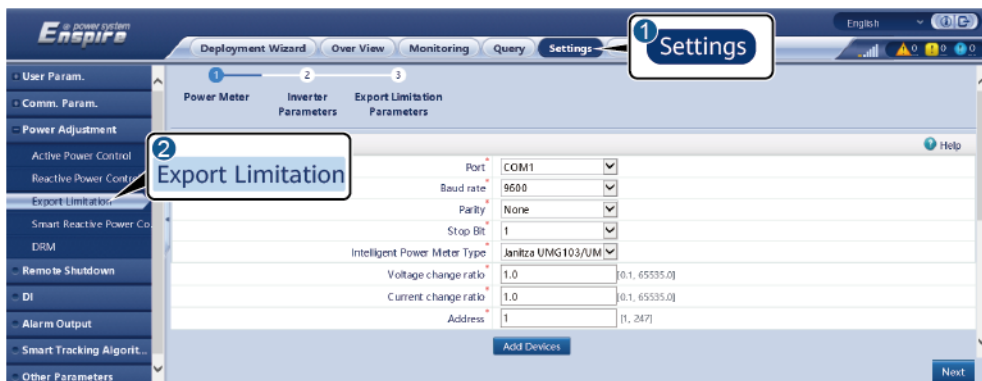

IL04J00011

----End

6.4.5 Setting Parameters for Smart Reactive Power Compensation

Context

The smart reactive power compensation algorithm obtains the power data of the gateway power meter through the SmartLogger, performs intelligent algorithm analysis, adjusts the reactive power output of the solar inverter, optimizes the power factor of the gateway, and reduces or avoids power factor charge to increase the energy yield of the PV plant.

NOTE

- Before setting the parameters, ensure that the solar inverters are connected to the SmartLogger.
- If a power meter is connected to the SmartLogger, the power meter access procedure in the wizard is only used as a check guide. If no power meter is connected to the SmartLogger, add a power meter by following the wizard.
- Before setting the parameters, ensure that the license for smart reactive power compensation has been loaded on the **Maintenance > License Management** page.

Procedure

Step 1 Set parameters as prompted. For details, click **Help** on the page.

Figure 6-53 Setting parameters for smart reactive power compensation

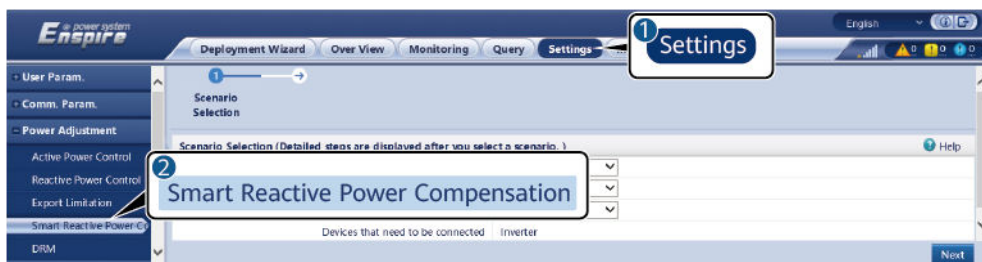

IL04J00014

NOTICE

When the SmartLogger receives a remote reactive power scheduling command from the PV plant, it automatically changes **Reactive power control mode** to **Remote communication scheduling**. If power factor closed-loop control is required, set **Reactive power control mode** to **Power factor closed-loop control** and set the target power factor correctly.

----End

6.4.6 Setting DRM Parameters

Context

According to an Australian standard, the inverters must comply with demand response modes (DRM).

Figure 6-54 Wiring diagram for the DRM function

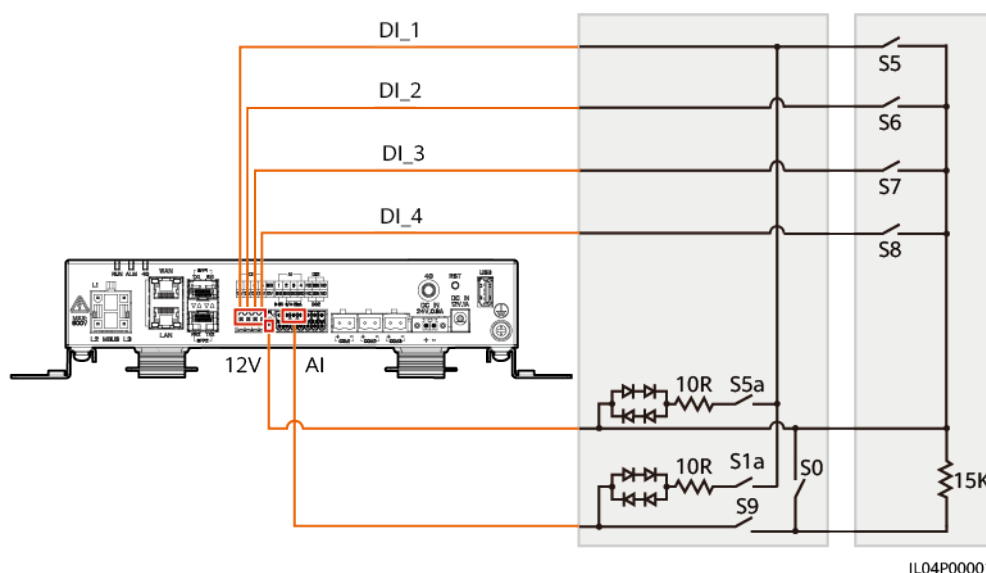

Table 6-7 DRM requirements

Mode	Corresponding Port on the SmartLogger	Requirements	Remarks
DRM0	AI2-AI4	<ul style="list-style-type: none"> When S0 is turned on, the inverters shut down. When S0 is turned off, the inverters are connected to the power grid. 	N/A
DRM5	DI1	When S5 is turned on, the inverters do not output active power.	When two or more DRM modes are

Mode	Corresponding Port on the SmartLogger	Requirements	Remarks
DRM6	DI2	When S6 is turned on, the output active power of the inverters does not exceed 50% of the rated power.	used at the same time, the strictest requirement must be met.
DRM7	DI3	When S7 is turned on, the output active power of the inverters does not exceed 75% of the rated power, and the inverters consume the maximum reactive power.	
DRM8	DI4	When S8 is turned on, the output active power of inverters recovers. NOTE The inverters output active power based on the percentage set on the SmartLogger.	

Procedure

- Step 1** Click **Settings** and ensure that **Active Power Control Mode** is set to **No limit**, **Reactive Power Control Mode** is set to **No output**, and **connection port** for **Remote Shutdown** is set to **No**.
- Step 2** Set DRM parameters and click **Submit**.

Figure 6-55 Setting DRM parameters

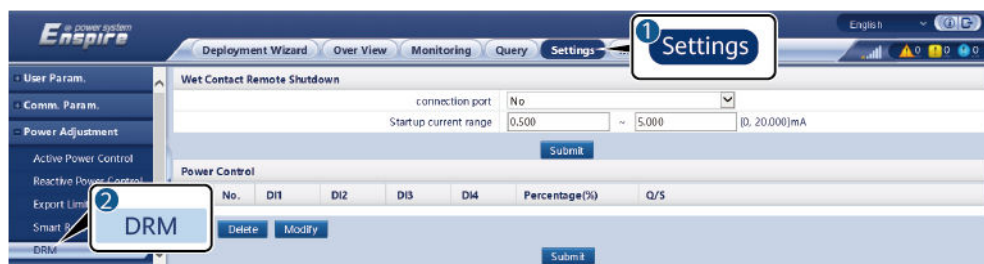

IL04J00015

Parameter	Description
connection port	Set the parameter to the AI port for DRM signals.
Startup current range	If the current of the AI port is within the setting range, inverters are turned on. Otherwise, inverters are turned off.

Parameter	Description
Power Control	Set DI parameters based on the DRM requirements.

----End

6.4.7 Setting Remote Shutdown

Context

The SmartLogger provides four DI ports. The OVGR can connect to any DI port. The SmartLogger shuts down the solar inverter over OVGR signals.

Figure 6-56 Networking

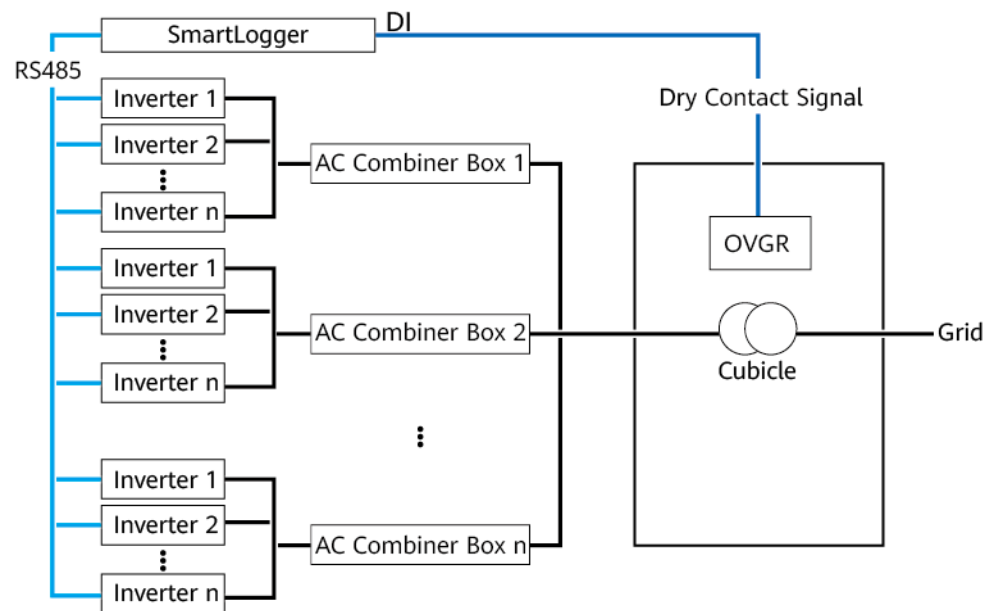

IL01IC3020

NOTICE

When setting this function, ensure that the user-defined DI port is not occupied. Otherwise, the setting will fail.

Procedure

Step 1 Set remote shutdown parameters.

Figure 6-57 Remote shutdown



IL04J00010

Parameter	Description
connection port	Set this parameter to the DI port connected to OVGR signals.
Effective dry contact status	The value can be Open or Close . NOTE If OVGR shutdown is enabled and this parameter is set to Close , the SmartLogger sends a solar inverter shutdown command only when the corresponding DI port is in the Close state.
OVGR shutdown	Specifies whether to enable shutdown over OVGR.
Cubicle alarm enabling	If this parameter is set to Enable , the Abnormal Cubicle alarm is raised when the dry contact signal is effective and the Cubicle is abnormal.

----End

7 Device Maintenance

7.1 Routine Maintenance

- Ensure that the SmartLogger is free from strong electromagnetic interference.
- Ensure that the SmartLogger is away from heat sources.
- Ensure that the heat dissipation holes are not blocked.
- Regularly clean the SmartLogger.
- Regularly check that cables are secured.

7.2 Troubleshooting

No.	Fault	Cause	Suggestions
1	The SmartLogger cannot be powered on.	<ol style="list-style-type: none">1. The DC output power cable for the power adapter is not connected the 12V IN port of the SmartLogger.2. The power cable is not connected to the AC power input port of the power adapter.3. The AC input power cable is not connected to the AC socket.4. The power adapter is faulty.5. The SmartLogger is faulty.	<ol style="list-style-type: none">1. Connect the DC output power cable for the power adapter to the 12V IN port of the SmartLogger.2. Check that the power cable is connected to the AC power input port of the power adapter.3. Check that the power cable is connected to the AC socket.4. Replace the power adapter.5. Contact the dealer or Huawei technical support.

No.	Fault	Cause	Suggestions
2	The SmartLogger cannot find any device.	<ol style="list-style-type: none"> 1. The COM ports are not connected to devices, or the cables are loose, disconnected, or reversely connected. 2. The RS485 communications parameters are not correctly set, and the solar inverter address is beyond the search range preset on the SmartLogger. 3. The devices that cannot be detected automatically, such as the EMI and power meter, are not manually added. 	<ol style="list-style-type: none"> 1. Check the RS485 cable connection. If the cable is loose, disconnected, or reversely connected, reconnect it firmly. 2. Check the RS485 communications parameter settings. Ensure that the baud rate and communication address are set correctly and that the solar inverter address is within the search range of the SmartLogger. 3. Manually add the devices that cannot be detected automatically, such as the EMI and power meter. 4. Contact the dealer or Huawei technical support.
3	The communication for MBUS networking failed.	<ol style="list-style-type: none"> 1. The solar inverter and SmartLogger do not support MBUS. 2. The AC power cable is loose, disconnected, or reversely connected. 3. The upstream circuit breaker for the AC power cable is turned off. 4. In MBUS networking, Built-in MBUS or Networking is set to Disable. 5. The SmartLogger is faulty. 	<ol style="list-style-type: none"> 1. Check whether the solar inverter and SmartLogger support MBUS. 2. Check the AC power cable. If it is loose, disconnected, or reversely connected, reconnect it firmly. 3. Check that the upstream circuit breaker for the AC power cable is turned on. 4. Set Built-in MBUS and Networking to Enable. 5. Contact the dealer or Huawei technical support.

No.	Fault	Cause	Suggestions
4	The device status is displayed as disconnected on the SmartLogger.	<ol style="list-style-type: none"> 1. The cable between the solar inverter and the SmartLogger is loose or disconnected. 2. The solar inverter is powered off. 3. The baud rate or RS485 address of the solar inverter is changed. 4. The solar inverter is replaced. 5. The solar inverter is removed and not reconnected. 	<ol style="list-style-type: none"> 1. Check the cable between the solar inverter and the SmartLogger. If the cable is loose or disconnected, reconnect it firmly. 2. Check the solar inverter connection and power on the solar inverter. 3. Check that the baud rate and RS485 address of the solar inverter are set correctly. 4. If any device is replaced, search for the device again or manually add the device. 5. If the device has been removed, perform the Remove Devices operation on the Device Mgmt. page.
5	The EMI fails in communication.	<ol style="list-style-type: none"> 1. The RS485 communications cable between the EMI and the SmartLogger is connected incorrectly, loose, or disconnected. 2. The EMI is not powered on. 3. The EMI and SmartLogger use different RS485 communications parameter settings. 4. The EMI parameters are incorrectly set. 	<ol style="list-style-type: none"> 1. Check the cable connection. If the cable is loose or disconnected, reconnect it firmly. 2. Power on the EMI. 3. Check that the RS485 communications parameters of the EMI are correctly. 4. Log in to the WebUI and ensure that the EMI parameters are set correctly.
6	The SmartLogger cannot communicate with the management system.	<ol style="list-style-type: none"> 1. The SmartLogger is not connected to the PC, or the cable is loose or disconnected. 2. The parameters of the wired or wireless network are incorrectly set. 3. The management system parameters are incorrectly set. 	<ol style="list-style-type: none"> 1. Check that the Ethernet port of the SmartLogger is correctly connected to the PC or a router. 2. Check that the parameters of the wired or wireless network are set correctly. 3. Check that the management system parameters are correctly set.

No.	Fault	Cause	Suggestions
7	The communication for RS485 networking failed.	<ol style="list-style-type: none"> 1. The RS485 communications cable is incorrectly connected, loose, or disconnected. 2. The SmartLogger is not powered on. 3. The RS485 communications parameters are incorrectly set. 	<ol style="list-style-type: none"> 1. Terminal block connection: Check that the RS485 communications cable is connected to the correct port of the terminal block. 2. RJ45 network port connection: Check that the RJ45 connector is properly crimped and that each wire is connected to the correct pin. 3. Check that the RS485 ports of other devices are connected to the correct ports of the SmartLogger. 4. Check the RS485 cable connection. If the cable is loose, disconnected, or reversely connected, reconnect it firmly. 5. Power on the SmartLogger and its connected device. 6. Check the RS485 communications parameter settings. 7. Contact the dealer or Huawei technical support.
8	The 4G communication is abnormal.	<ol style="list-style-type: none"> 1. The SIM card is not inserted or it is in arrears or damaged. 2. The 4G antenna is not tightened or is damaged. 3. The management system parameters and wireless network parameters are incorrectly set. 4. The SIM card registration failed. 	<ol style="list-style-type: none"> 1. Insert or replace the SIM card. 2. Tighten or replace the 4G antenna. 3. Check that the management system parameters and wireless network parameters are set correctly. 4. Contact the SIM card carrier or Huawei technical support.

7.3 Alarm List

Alarm ID	Alarm Name	Alarm Severity	Alarm Sub-ID	Cause	Suggestions
1100	Active Power Scheduling Instruction Exception	Major	4	In Dry contact remote control mode of the active power, the four DI ports read command combinations that are not configured.	<ol style="list-style-type: none"> 1. Check that the cables are connected correctly to the DI ports. 2. Access the Dry contact remote control configuration page of the active power and check the mapping table of the DI signal configuration. 3. Contact the power grid company to check that the configurations in the mapping table are complete and meet the requirements.
1101	Reactive Power Scheduling Instruction Exception	Major	4	In Dry contact remote control mode of the reactive power, the four DI ports read command combinations that are not configured.	<ol style="list-style-type: none"> 1. Check that the cables are connected correctly to the DI ports. 2. Access the Dry contact remote control configuration page of the reactive power and check the mapping table of the DI signal configuration. 3. Contact the power grid company to check that the configurations in the mapping table are complete and meet the requirements.
1103	General Circuit Breaker Disconnected	Major	1	The general circuit breaker at the grid connection point is disconnected.	Check whether the disconnection is a normal. If it is abnormal, contact service engineers to reconnect the circuit breaker.
1104	Abnormal Cubicle	Major	1	The Cubicle device has detected an exception at the grid connection point.	When the Cubicle alarm is enabled, check whether the DI signal received by the SmartLogger is consistent with the dry contact status. If yes, restart the solar inverter.

Alarm ID	Alarm Name	Alarm Severity	Alarm Sub-ID	Cause	Suggestions
1105	Device Address Conflict	Major	1	The SmartLogger RS485 address conflicts with the physical address (RS485 address) or logical address for the connected southbound device.	<ul style="list-style-type: none"> • If the SmartLogger RS485 address conflicts with the communications address for the connected southbound device, choose Settings > Modbus TCP and change the SmartLogger address, or choose Maintenance > Device Mgmt. > Connect Device and change the southbound device address. If the southbound device is a solar inverter, you can change its address on the app. • If the SmartLogger RS485 address conflicts with the logical address for the connected southbound device, choose Settings > Modbus TCP and change the SmartLogger address.
1106	AC SPD Fault	Major	1	The SPD in the smart array controller is faulty.	<ul style="list-style-type: none"> • Check whether the cable to the SPD in the smart array controller is loose, disconnected, or reversely connected. If so, reconnect the cable firmly. • Check whether the SPD in the smart array controller is faulty. If so, replace the faulty SPD.
1107–1110	DI1 user-defined alarm to DI4 user-defined alarm	Major	1	The dry contact signal from the peripheral to the corresponding DI port of the SmartLogger is abnormal.	<ul style="list-style-type: none"> • Check the DI port cable connection. If the cable is loose, disconnected, or reversely connected, reconnect it firmly. • Check that the relevant device works properly.
1111–1114	M1.DI1 user-defined alarm to M1.DI4 user-defined alarm	Major	1	The dry contact signal from the peripheral to the corresponding DI port of the SmartModule is abnormal.	<ul style="list-style-type: none"> • Check the DI port cable connection. If the cable is loose, disconnected, or reversely connected, reconnect it firmly. • Check that the relevant device works properly.

Alarm ID	Alarm Name	Alarm Severity	Alarm Sub-ID	Cause	Suggestions
1115	24 V Power Failure	Major	1	The 24 V power supply in the smart array controller is faulty.	<ol style="list-style-type: none"> 1. Check whether the cable to the 24 V power supply in the smart array controller is loose, disconnected, and connected in reverse. If so, reconnect the cable securely. 2. Check whether the 24 V power supply in the smart array controller is faulty. Replace the faulty power module.
1116	WebUI Server Certificate Invalid	Warning	1	WebUI Server Digital Signature Certificate Invalid	Check the time or change the digital signature certificate.
1117	WebUI Server Certificate to Expire	Warning	1	WebUI Server Digital Signature Certificate to Expire	Change the digital signature certificate in time.
1118	WebUI Server Certificate Expired	Major	1	WebUI Server Digital Signature Certificate Expired	Change the digital signature certificate immediately.
1119	License Expired	Warning	1	<ul style="list-style-type: none"> • The privilege license has entered the grace period. • The privilege feature will be invalid soon. 	Apply for a new license and replace the current one.
1120	Management System Certificate Invalid	Warning	1	Management System Digital Signature Certificate Invalid	Check the time or change the digital signature certificate.

Alarm ID	Alarm Name	Alarm Severity	Alarm Sub-ID	Cause	Suggestions
1121	Management System Certificate to Expire	Warning	1	Management System Digital Signature Certificate to Expire	Change the digital signature certificate in time.
1122	Management System Certificate Expired	Major	1	Management System Digital Signature Certificate Expired	Change the digital signature certificate immediately.
1123	Remote Output Control Certificate Invalid	Warning	1	Remote Output Control Digital Signature Certificate Invalid	Check the time or change the digital signature certificate.
1124	Remote Output Control Certificate to Expire	Warning	1	Remote Output Control Digital Signature Certificate to Expire	Change the digital signature certificate in time.
1125	Remote Output Control Certificate Expired	Major	1	Remote Output Control Digital Signature Certificate Expired	Change the digital signature certificate immediately.
1126	Poverty Alleviation Monitoring Center Certificate Invalid	Warning	1	Poverty Alleviation Monitoring Center Digital Signature Certificate Invalid	Check the time or change the digital signature certificate.

Alarm ID	Alarm Name	Alarm Severity	Alarm Sub-ID	Cause	Suggestions
1127	Poverty Alleviation Monitoring Center Certificate to Expire	Warning	1	Poverty Alleviation Monitoring Center Digital Signature Certificate to Expire	Change the digital signature certificate in time.
1128	Poverty Alleviation Monitoring Center Certificate Expired	Major	1	Poverty Alleviation Monitoring Center Digital Signature Certificate Expired	Change the digital signature certificate immediately.
1129	SmartLogger Certificate Invalid	Warning	1	The SmartLogger digital signature certificate is invalid.	Check the time or change the digital signature certificate.
1130	SmartLogger Certificate About to Expire	Warning	1	The SmartLogger digital signature certificate is about to expire.	Change the digital signature certificate in time.
1131	SmartLogger Certificate Expired	Major	1	The SmartLogger digital signature certificate has expired.	Change the digital signature certificate immediately.
1251	SmartModule Certificate Invalid	Warning	1	The SmartModule digital signature certificate is invalid.	Check the time or change the digital signature certificate.

Alarm ID	Alarm Name	Alarm Severity	Alarm Sub-ID	Cause	Suggestions
1252	SmartModule Certificate About to Expire	Warning	1	The SmartModule digital signature certificate is about to expire.	Change the digital signature certificate in time.
1253	SmartModule Certificate Expired	Major	1	The SmartModule digital signature certificate has expired.	Change the digital signature certificate immediately.

7.4 WebUI Maintenance Operations

7.4.1 Upgrading the Device Firmware Version

Context

You can upgrade the firmware of the SmartLogger, solar inverter, MBUS module, or PID module over the WebUI.

Procedure

Step 1 Perform an upgrade.

Figure 7-1 Upgrade

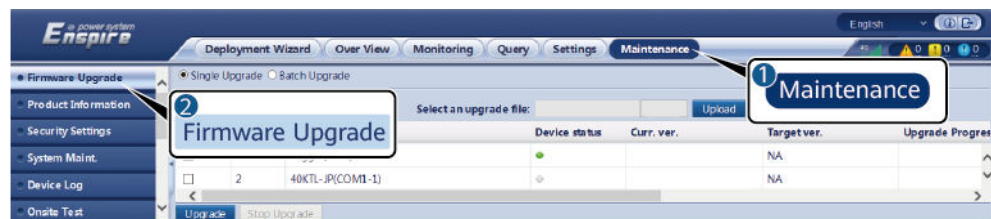

IL03J00037

Tab	Function	Operation Description
Single Upgrade	Upgrade a device of any type. NOTE The Single Upgrade mode does not apply to two or more types of device at a time. For example, you cannot select both SUN2000 and MBUS .	<ol style="list-style-type: none"> 1. Select the upgrade package and click Upload. 2. Select the device that requires a firmware upgrade. 3. Click Upgrade.
Batch Upgrade	Upgrade solar inverters in batches.	<ol style="list-style-type: none"> 1. Select the upgrade package and click Upload. 2. Click Upgrade.

 **NOTE**

The **Stop Upgrade** function applies only to the devices waiting to be upgraded.

----End

7.4.2 Setting Security Parameters

Figure 7-2 Security settings

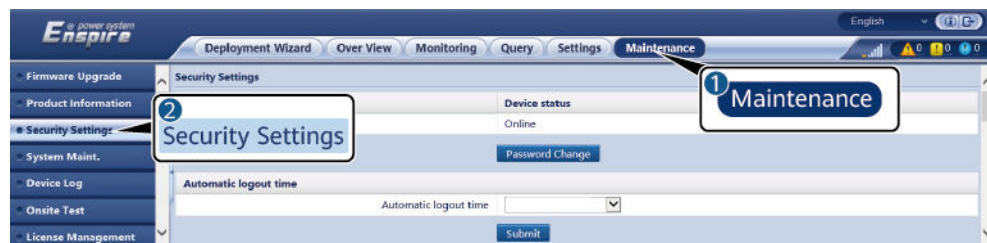

IL03J00038

Parameter	Description
Password Change	Change the password for the current login user to log in to the WebUI.
Automatic logout time	After this parameter is set, a user is automatically logged out if the user does not perform any operation within the period specified by this parameter.
WebUI Security Certificate	You are advised to use the existing network security certificate and key.
Update Key	Update the key for saving the password.

Parameter	Description
SmartModule Security Certificate	Load the network security certificate of the SmartModule. If the private key file has a password, select Enable key password and enter the key password obtained from the certificate provider.
Communication using expired certificate	Specifies whether to enable communication using an expired certificate. If this parameter is set to Enable , the SmartLogger can communicate with the SmartModule. After the certificate expires, set this parameter to Disable to prevent the SmartLogger from communicating with the SmartModule to ensure network security.
TLS1.0 enable	Enables or disables the TLS1.0 function.
Digital signature verification for upgrade package	<ul style="list-style-type: none"> If this parameter is set to Enable, the upgrade package must contain the digital signature file and the upgrade package must not be modified. If this parameter is set to Disable, the digital signature of the upgrade package is not verified.

7.4.3 Sending a System Maintenance Command

Figure 7-3 System maintenance



IL03J00039

Function	Description
Reset System	Resets the SmartLogger, which will automatically shut down and restart.

Function	Description
Restore Factory Settings	After the factory settings are restored, all configured parameters (except the current date, time, and communication parameters) are restored to their factory default values. The running information, alarm records, and system logs are not changed. Exercise caution when deciding to perform this operation.
Clear Data	Clears all historical data of the SmartLogger.
Full profile export	Before replacing the SmartLogger, export the SmartLogger configuration file to a local PC.
Full profile import	After replacing the SmartLogger, import the local configuration file to the new SmartLogger. After the import is successful, the SmartLogger restarts for the configuration file to take effect. Ensure that the parameters on the Settings tab page and the parameters for the built-in MBUS are correctly set.

7.4.4 Exporting Device Logs

Procedure

Step 1 Access the device log page.

Figure 7-4 Exporting logs

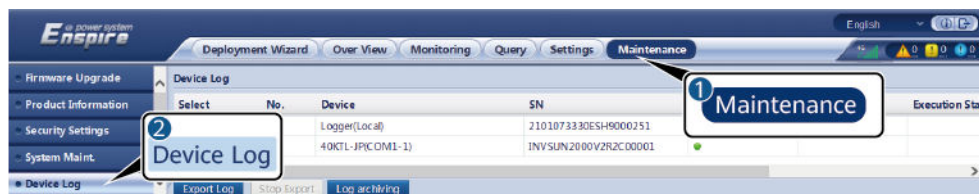

IL03J00040

Step 2 Select the device whose logs are to be exported and click **Export Log**.

NOTE

- Logs of two or more types of devices cannot be exported at a time. For example, you cannot select both **SUN2000** and **MBUS**.
- Logs can be exported for a maximum of five devices of the same type at a time.

Step 3 Observe the progress bar and wait until the log export is complete.

Step 4 After the export is successful, click **Log archiving** to save the logs.

----End

7.4.5 Starting an Onsite Test

Context

After an inverter is put into use, you need to periodically check its health to detect potential risks and problems.

Procedure

Step 1 Start an onsite test.

Figure 7-5 Onsite test

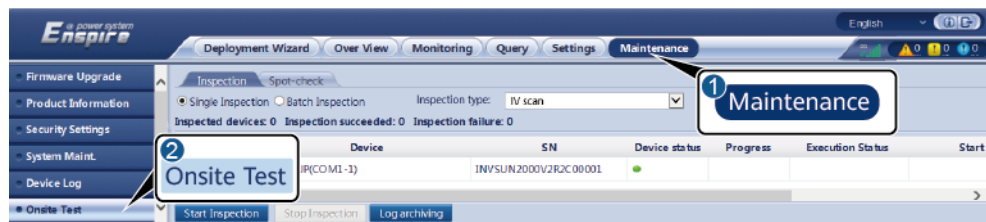

IL03J00041

Tab	Function	Operation Description
Inspection	Check the health status of the inverter.	<ol style="list-style-type: none"> 1. If Single Inspection is selected, select the device to be inspected. If Batch Inspection is selected, you do not need to select a device. 2. Set Inspection type. 3. Click Start Inspection. 4. Observe the progress bar and wait until the inspection is complete. 5. After the inspection is successful, click Log archiving to download the inspection log.
Spot-check	Start a spot-check. NOTE The spot-check function is available only for a device whose grid code is set to the Japanese standard.	<ol style="list-style-type: none"> 1. Select the device to be spot-checked. 2. Click Start Spot-Check. 3. Perform a spot-check test onsite. 4. After the spot-check test is complete, click Stop Spot-Check.

----End

7.4.6 Managing Licenses

Context

The smart I-V curve diagnosis, smart PV string monitoring, smart tracking algorithm, and smart reactive power compensation functions can be used only after a license is purchased.

The license files for smart I-V curve diagnosis and smart PV string monitoring need to be stored in the solar inverter, and the license files for smart tracking algorithm and smart reactive power compensation need to be stored in the SmartLogger. The matching between the SN of a device and a license is unique.

License management allows you to view the license information about the solar inverter and obtain the current license status. Before a device is replaced, the current device license needs to be revoked so that the revocation code can be generated and used for applying for a new device license.

The size of the license file imported to the SmartLogger must be less than 1 MB. Otherwise, the page will be abnormal.

Procedure

Step 1 Access the license management page.

Figure 7-6 License management

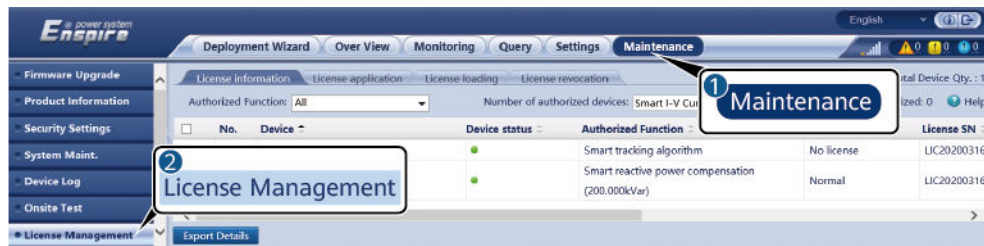

IL03J00042

Tab	Function	Operation Description
License information	Views the license information.	<ol style="list-style-type: none"> 1. Select the name of the device whose license details are to be exported. 2. Click Export Details.
License application	Exports the license application file.	<ol style="list-style-type: none"> 1. Select the name of the device for which you want to apply for a license. 2. Click Export License Appli File. 3. Purchase a license from Huawei and obtain the license file from Huawei technical support engineers.

Tab	Function	Operation Description
License loading	Loads the obtained license to the corresponding device.	<ol style="list-style-type: none">1. Click Upload License.2. Select the name of the device whose license is to be loaded.3. Click Load License.
License revocation	Revokes a license or exports the revocation code file.	<ol style="list-style-type: none">1. Select the name of the device whose license is to be revoked.2. Click Revoke License.3. Click Export Revo Code File.

 **NOTE**

Ensure that the extension of the license file to be imported is .dat or .zip.

----End

7.4.7 Managing the SmartModule

Context

When replacing the SmartModule, you need to manually remove the device on the WebUI.

Procedure

1. Choose **Maintenance > Device Mgmt. > SmartModule**.
2. Select the device to be removed and click  to remove it.

 **NOTE**

is used to change the secondary authentication password of the SmartModule.

7.4.8 Collecting Performance Data

Context

You can recollect the solar inverter performance data as well as daily, monthly, and yearly energy yields.

Procedure

- Step 1** Choose **Maintenance > Device Mgmt. > Data Re-Collection**.
- Step 2** Select the type of the data to be collected and set the collection period.
- Step 3** Select the name of the device whose data is to be collected and click **Collect Data**.

Step 4 Wait until all data is gathered. On the **Monitoring** page, query the collection result.

----End

7.4.9 Adjusting the Total Energy Yield

Procedure

Step 1 Choose **Maintenance > Device Mgmt. > Adjust total energy yield**.

Step 2 Set **Adjust total energy yield(kWh)**, select the name of the device whose total energy yield needs to be adjusted, and click **Submit**.

----End

7.5 Device Disposal

If the service life of the SmartLogger expires, dispose of the SmartLogger according to the local disposal act for waste electric appliances.

8 FAQ

8.1 How Do I Connect the SmartLogger to the SUN2000 App or FusionSolar App?

Prerequisites

- The SmartLogger has been powered on.
- The WLAN function has been enabled on the SmartLogger.

NOTE

- By default, **WLAN** is set to **OFF in idle state**.
- When **WLAN** is set to **OFF in idle state**, the WLAN function is available within 4 hours after the SmartLogger is powered on. In other cases, hold down the RST button (for 1s to 3s) to enable the WLAN function.
- If **WLAN** is set to **Always OFF**, choose **Settings > Wireless Network** on the SmartLogger WebUI and set **WLAN** to **Always ON** or **OFF in idle state**.
- The FusionSolar app is recommended when the SmartLogger is connected to the FusionSolar hosting cloud. The SUN2000 app is recommended when the SmartLogger is connected to other management systems.
- The SUN2000 app or FusionSolar app has been installed on the mobile phone.

Context

- The SUN2000 app or FusionSolar app communicates with the SmartLogger through the WLAN to provide functions such as alarm query, parameter settings, and routine maintenance.
- Mobile phone operating system: Android 4.0 or later
- Access the Huawei app store (<https://appstore.huawei.com>), search for **SUN2000** or **FusionSolar**, and download the app installation package.

Figure 8-1 WLAN connection range

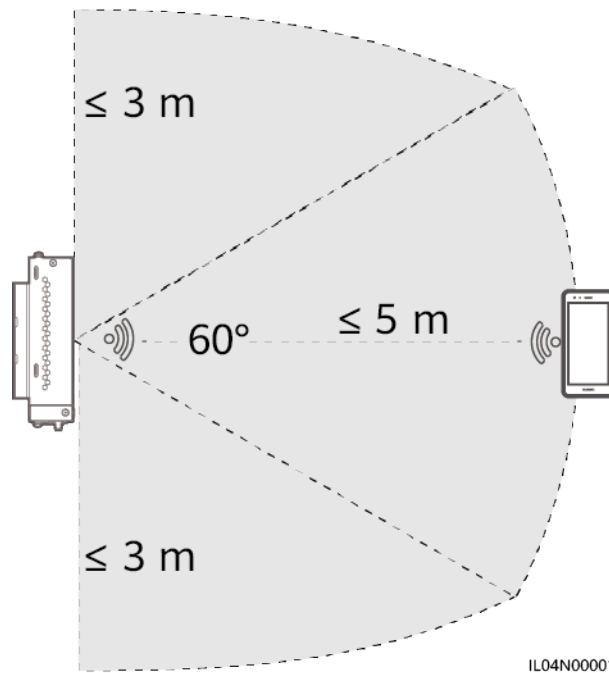

Procedure

Step 1 Log in to the app.

1. (Connecting the SmartLogger to the FusionSolar Hosting Cloud) Open the FusionSolar app, log in to intl.fusionsolar.huawei.com as installer account, and choose **My > Device commissioning** to connect to the WLAN hotspot of the SmartLogger.
2. (Connecting the SmartLogger to Other Management Systems) Open the SUN2000 app and connect to the WLAN hotspot of the SmartLogger.
3. Select **installer** and enter the login password.
4. Tap **LOG IN** and go to the **Quick Settings** screen or **SmartLogger** screen

NOTE

- The screenshots in this document correspond to SUN2000 app and the FusionSolar app local commissioning tool version 3.2.00.002 (Android).
- The initial WLAN hotspot name of the SmartLogger is **Logger_SN** and the initial password is **Changeme**. The SN can be obtained from the SmartLogger label.
- The initial passwords of **installer** and **user** are both **00000a** for the SUN2000 app and FusionSolar app device commissioning.
- Use the initial password upon first power-on and change it immediately after login. To ensure account security, change the password periodically and keep the new password in mind. Not changing the initial password may cause password disclosure. A password left unchanged for a long period of time may be stolen or cracked. If a password is lost, the device cannot be accessed. In these cases, the user is liable for any loss caused to the PV plant.
- If the SmartLogger is powered on for the first time or the factory defaults are restored and parameter configuration is not performed on the WebUI, the quick settings screen is displayed after you log in to the app. You can set parameters based on site requirements.

Figure 8-2 Logging in to the app

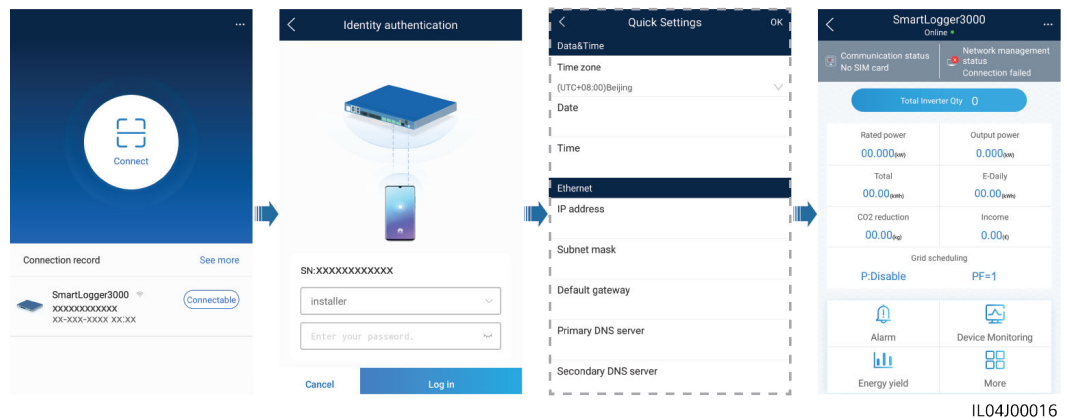

IL04J00016

----End

8.2 How Do I Set FTP Parameters?

Context

The FTP function is used to access a third-party NMS. The SmartLogger can report the configuration information and running data of the managed PV plant system through FTP. A third-party NMS can access Huawei devices after being configured.

FTP is a universal standard protocol without any security authentication mechanism. Data transmitted by FTP is not encrypted. To reduce network security risks, the IP address of the connected third-party FTP server is left blank by default. This protocol can transmit the running data of PV plants, which may cause user data breach. Therefore, exercise caution when using this protocol. Users are liable for any loss caused by the enabling of the FTP protocol (non-secure protocol). Users are advised to take measures at the PV plant level to reduce security risks, or use Huawei management system to mitigate the risks.

Procedure

- Step 1 Set FTP parameters and click **Submit**.

Figure 8-3 Setting FTP parameters

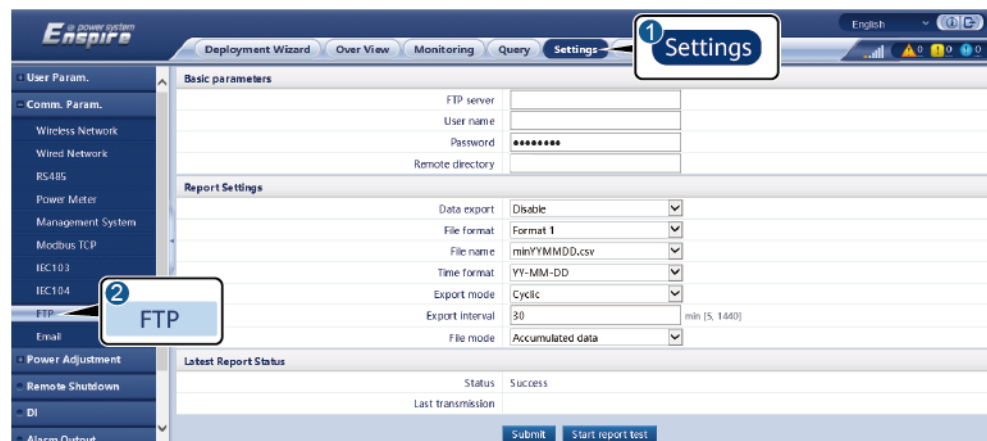

IL04J00017

Parameter	Description
FTP server	Set this parameter to the domain name or IP address of the FTP server.
User name	Set this parameter to the user name for logging in to the FTP server.
Password	Set this parameter to the password for logging in to the FTP server.
Remote directory	After you set this parameter, a subdirectory of the same name is created in the default data upload directory (specified by the FTP server).
Data export	Specifies whether data can be reported.
File format	Format 1, Format 2, Format 3, and Format 4 are supported. NOTE Format 2 has two more information points than Format 1 : E-Day (current-day energy yield) and E-Total (total energy yield). Format 3 has more information points than Format 1 and Format 2 : power meter, PID module, user-defined device, and SmartLogger data. Format 4 has more information points than Format 3 : active and reactive power of power meters.
File name	Set this parameter to the format of the file name.
Time format	Set this parameter to the time format.
Export mode	The value can be Cyclic or Fixed time . <ul style="list-style-type: none"> ● Cyclic: Periodically reports data. Export interval specifies the period for reporting data. File mode specifies whether all data or only the incremental data of a day is reported each time. ● Fixed time: Reports data at a specified time. Fixed time specifies the time for reporting data.

 **NOTE**

You can click **Start report test** to check whether the SmartLogger can report data to the FTP server.

----End

Troubleshooting

NOTICE

If the error code is not listed in the following table, provide SmartLogger run logs and contact Huawei technical support.

Error Code	Troubleshooting Suggestion	Error Code	Troubleshooting Suggestion
0x1002	Configure the FTP server address.	0x1003	<ol style="list-style-type: none">1. Check whether the DNS server address is correctly configured.2. Check whether the domain name of the third-party FTP server is correctly configured.
0x1004	Configure the user name of the FTP account.	0x1005	Configure the user name of the FTP account.
0x3001	<ol style="list-style-type: none">1. Check whether the FTP server address is correctly configured.2. Check whether the third-party FTP server is working properly.	0x3002	<ol style="list-style-type: none">1. Check whether the user name of the FTP account is correctly configured.2. Check whether the password of the FTP account is correctly configured.
0x3007	Check whether the third-party FTP server allows the client to upload data.	0x3008	Ensure that the SmartLogger data upload directory exists on the third-party FTP server.
Other Codes	Provide SmartLogger run logs and contact Huawei technical support.	N/A	N/A

8.3 How Do I Set Email Parameters?

Context

The SmartLogger can send emails to inform users of the current energy yield information, alarm information, and device status about the PV plant system, helping users know the running conditions of the PV plant system in time.

When using this function, ensure that the SmartLogger can connect to the configured email server and the Ethernet parameters and email parameters are correctly set for the SmartLogger.

Procedure

Step 1 Set email parameters and click **Submit**.

Figure 8-4 Setting email parameters

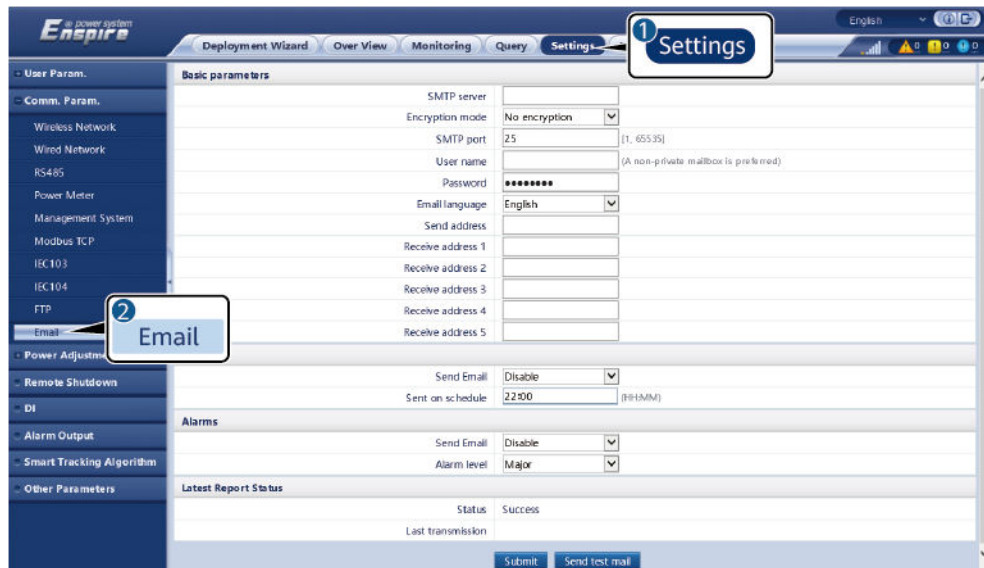

IL04J00018

Parameter	Description
SMTP server	Set this parameter to the domain name or IP address of the SMTP server.
Encryption mode	Set this parameter to the email encryption mode.
SMTP port	Set this parameter to the email sending port.
User name	Set this parameter to the user name for logging in to the SMTP server.
Password	Set this parameter to the password for logging in to the SMTP server.
Email language	Set this parameter to the language for sending emails.
Send address	Set this parameter to the email address for sending emails.
Receive address N NOTE N is 1, 2, 3, 4, or 5.	Set this parameter to the email address for receiving emails.
Yield	Specifies whether to send energy yield data by email and the time for sending emails.
Alarms	Specifies whether to send alarms by email and the severity of the alarms to be sent.

 NOTE

You can click **Send test mail** to check whether the SmartLogger can successfully send emails to users.

----End

Troubleshooting

NOTICE

If the error code is not listed in the following table, provide SmartLogger run logs and contact Huawei technical support.

Error Code	Troubleshooting Suggestion	Error Code	Troubleshooting Suggestion
0x2002	<ol style="list-style-type: none">1. Check whether the DNS server address is correctly configured.2. Check whether the domain name and the IP address of the SMTP server are correct.3. Check whether the network communication between the management system and the DNS server is normal.	0x2003	<ol style="list-style-type: none">1. Try again later.2. Check whether the domain name and the IP address of the SMTP server are correct.
0x200b	<ol style="list-style-type: none">1. Check whether the DNS server address is correct.2. Check whether the domain name and the IP address of the SMTP server are correct.	0x4016	<ol style="list-style-type: none">1. Try again later.2. Check whether the DNS server address is correctly configured.3. Check whether the domain name and the IP address of the SMTP server are correct.
0x406e	Confirm the encryption mode and port supported by the email box, and check whether they are correct.	0x8217	<ol style="list-style-type: none">1. Check whether the user name and password are correct.2. Log in to the email box of the email sender and start the SMTP service.3. Log in to the email box of the email sender and start the third-party client license code function.

Error Code	Troubleshooting Suggestion	Error Code	Troubleshooting Suggestion
0xa003	Check whether the domain name and the IP address of the SMTP server are correct.	0xa005	Enter the user name correctly.
0xa006	Enter the password correctly.	0xe002	Configure the domain/IP of the SMTP server correctly.
0xe003	Configure the addresses for sending and receiving emails correctly.	Others	Please provide SmartLogger running logs and contact Huawei Service Center.

8.4 How Do I Change the SSID and Password of the Built-in WLAN?

Procedure

Step 1 Choose **Settings > Wireless Network**, set parameters for the built-in WLAN, and click **Submit**.

Parameter	Description
WLAN	Specifies the status of the built-in WLAN. <ul style="list-style-type: none">• Always ON: The WLAN module is powered on.• OFF in idle state: The WLAN module is automatically powered off when idle. You can hold down the RST button for 1s to 3s to power on the WLAN module and wait for connecting to the SUN2000 app. If the SUN2000 app is not connected, the WLAN module is automatically powered off after it is powered on for 4 hours.• Always OFF: The WLAN module is not powered on and cannot be powered on by holding down the button.
SSID	<ul style="list-style-type: none">• Specifies the name of the built-in WLAN.• The default name of the built-in WLAN is Logger_SN.

Parameter	Description
Password	<ul style="list-style-type: none"> Specifies the password for accessing the built-in WLAN. The initial password of the built-in WLAN is Changeme. Use the initial password upon first power-on and change it immediately after login. To ensure account security, change the password periodically and keep the new password in mind. Not changing the initial password may cause password disclosure. A password left unchanged for a long period of time may be stolen or cracked. If a password is lost, the device needs to be restored to factory settings. In these cases, the user is liable for any loss caused to the PV plant.

----End

8.5 How Do I Use DI Ports?

The SmartLogger provides four DI ports, which support DI active scheduling, DI reactive scheduling, DRM, remote shutdown, and input of correlated alarms.

For details about DI active scheduling, DI reactive scheduling, DRM and remote shutdown, see [6.4 Power Grid Scheduling](#).

NOTICE

Before setting the corresponding function, ensure that the DI port is not set for other purposes. Otherwise, the setting will fail.

Alarm Input

When a valid level is delivered into a DI port, an alarm is raised. You can set the alarm name and severity.

Step 1 Choose **Settings > DI** and associate alarms with DI ports.

Parameter	Description
Activation status	If this parameter is set to Activated for a DI port, you can set the function of the DI port. Otherwise, you cannot set the function of the DI port.
Dry contact status	Specifies the valid input status of a DI port.
Alarm generation	Specifies whether to allow alarm generation.
Alarm severity	Specifies the alarm severity.

Parameter	Description
Trigger shutdown	Specifies whether to deliver a solar inverter remote shutdown command.
Trigger startup	Specifies whether to deliver a solar inverter remote startup command.
Alarm name	Specifies the alarm name.
Startup delay	Specifies the delay time for the automatic startup of the solar inverter after Trigger startup is set to Enable .

----End

8.6 How Do I Use DO Ports?

The SmartLogger provides two DO ports, which support the reset of external routers, audible and visual alarming for grounding faults, and output of correlated alarms.

NOTICE

Before setting the corresponding function, ensure that the DO port is not set for other purposes. Otherwise, the setting will fail.

Resetting an External Router

Connect one DC power cable of the 3G router to a DO port on the SmartLogger, and power on or off the wireless module by connecting or disconnecting the DO dry contact to control the reset of the 3G router.

- Step 1** Cut off a DC power cable of the router, and connect the DC power cable to a DO port on the SmartLogger.

Figure 8-5 Connecting to a DO port

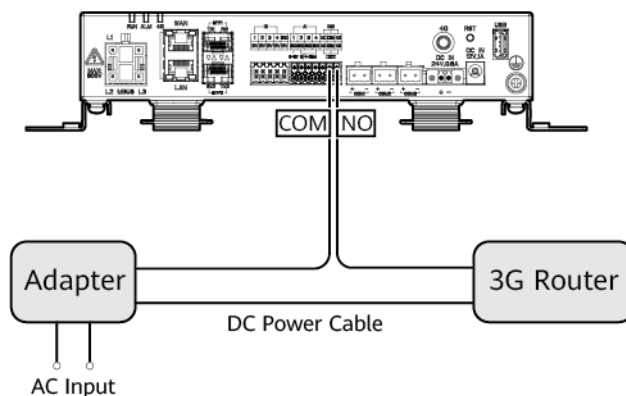

IL04100001

- Step 2** Choose **Settings > Other parameters** and set **Reset the external router** to the DO port.

----End

Audible and Visual Alarm for Grounding Fault

Connect one DC power cable of the audible and visual alarm to a DO port on the SmartLogger, and power on or off the audible and visual alarm by connecting or disconnecting the DO dry contact to implement audible and visual alarming for grounding faults.

- Step 1** Connect one DC power cable of the audible and visual alarm to the DO port (COM/NO) on the SmartLogger.

- Step 2** Choose **Settings > Alarm Output** and associate **Low Insulation Resistance** with the DO port.

----End

Alarm Output

After a solar inverter alarm is associated with a DO port, the alarm signal is delivered from the DO port when the solar inverter raises the alarm.

- Step 1** Choose **Settings > Alarm Output** and associate solar inverter alarms with the DO port.

NOTE

If the SmartLogger is restarted or powered off after the function is enabled, the DO port status may change and the alarm output may be abnormal.

----End

8.7 How Do I Use the USB Port?

The SmartLogger has a USB port, which provides 5 V/1 A power supply.

- The USB port can connect to a 3G router to supply power to the router, and the power supply of the USB port is disconnected when communication is disconnected, implementing 3G router reset control.

NOTICE

If the maximum operating current of the 3G router is greater than 1 A, it cannot be connected through the USB port.

- The USB port can connect to a USB flash drive for local maintenance, device log export, and device upgrade.

NOTE

It is recommended that you use a SanDisk, Netac, or Kingston USB flash drive to ensure compatibility.

Connecting to a 3G Router

If the DC power cable of the 3G router has a standard USB connector with the maximum operating current of less than 1 A, it can be directly connected to the USB port on the SmartLogger.

- Step 1** Connect the USB connector of the DC power cable for the 3G router to the USB port on the SmartLogger.
- Step 2** If you need to use the reset function of the external router, choose **Settings > Other Parameters** and set **Reset the external router** to **USB**.

----End

Connecting to a USB Flash Drive for Local Maintenance

- Step 1** Insert the USB flash drive into the USB port at the bottom of the SmartLogger.
- Step 2** Log in to the app as **installer**, choose **More > System Maintenance** on the SmartLogger screen, and perform the local maintenance.

Local Maintenance	Description	Prerequisites
Offline Configuration	After the power station deployment configuration file is imported through Offline Configuration, the SmartLogger automatically completes the deployment configuration.	The power station deployment configuration file has been saved in the root directory of the USB flash drive.
Exporting All Files	Before replacing the SmartLogger, export the SmartLogger configuration file to a local PC.	N/A
Importing All Files	After replacing the SmartLogger, import the local configuration file to the new SmartLogger. After the import is successful, the SmartLogger restarts for the configuration file to take effect. Ensure that the parameters on the Settings tab page and the parameters for the built-in MBUS are correctly set.	All exported files have been saved in the root directory of the USB flash drive.

Step 3 After the local maintenance is complete, remove the USB flash drive.

NOTICE

After files are imported, the SmartLogger automatically restarts.

----End

Connecting to a USB Flash Drive to Export Device Logs

Step 1 Connect the USB flash drive to the USB port on the SmartLogger.

Step 2 Log in to the app as **installer**, choose **More > Device Logs**, select the device whose logs you want to export, and tap **Next**.

Step 3 Select the types of logs to be exported and tap **Confirm** to start exporting device logs.

Step 4 After the logs are exported, remove the USB flash drive.

----End

Connecting to a USB Flash Drive for Device Upgrade

You can upgrade the SmartLogger, solar inverter, MBUS module, or PID module using a USB flash drive.

Step 1 Save the device upgrade package to the USB flash drive.

 **NOTE**

Do not decompress the upgrade package.

Step 2 Connect the USB flash drive to the USB port on the SmartLogger.

Step 3 Log in to the app as **installer**, choose **More > Upgrade**, select a single device or multiple devices of the same type, and tap **Next**.

Step 4 Select the upgrade package and tap **Next**.

Step 5 Confirm the upgrade package and the device to be upgraded, and tap **Finish** to start upgrading the device.

 **NOTE**

After the upgrade is complete, the device automatically restarts.

Step 6 After the upgrade is complete, remove the USB flash drive.

----End

8.8 How Do I Change a Device Name?

Procedure

- Step 1** Choose **Maintenance > Device Mgmt > Device List**.
- Step 2** Modify the device name based on the actual situation, select the modified entry, and click **Modify Device Info**.

NOTE

You can also export device information to a .csv file, modify the file, and import the modified file to modify device information.

----End

8.9 How Do I Change the Communications Address?

The SmartLogger allows you to change the communications addresses of Huawei devices on the **Connect Device** or **Device List** page.

Changing the Communications Address on the Connect Device Page

- Step 1** Choose **Maintenance > Device Mgmt. > Connect Device**.
- Step 2** Click **Auto Assign Address**, set the start address for assignment, and confirm the address assignment.
- Step 3** Confirm the address adjustment, adjust the device address as required, and click **Address Adjustment**.
- Step 4** Confirm to search for the device again.
- Step 5** After the search is complete, click **Close**.

----End

Changing the Communications Address on the Device List Page

- Step 1** Choose **Maintenance > Device Mgmt. > Device List**.
- Step 2** Change the device communications address and device name based on the site requirements, select the modified entries, and click **Modify Device Info**.
- Step 3** Choose **Maintenance > Device Mgmt. > Connect Device** and click **Auto. Search**.
- Step 4** After the search is complete, click **Close**.

----End

8.10 How Do I Export Inverter Parameters?

Context

You can export configuration parameters of multiple solar inverters to a .csv file. Site engineers can then check whether the solar inverter configurations are correct in the exported file.

Procedure

- Step 1** Choose **Maintenance > Device Mgmt > Export Param.**
- Step 2** Select the name of the device whose parameters are to be exported, and click **Export.**
- Step 3** Observe the progress bar and wait until the export is complete.
- Step 4** After the export is successful, click **Log archiving** to save the file.

----End

8.11 How Do I Clear Alarms?

Context

You can clear all active and historical alarms for the selected device and re-collect alarm data.

Procedure

- Step 1** Choose **Maintenance > Device Mgmt. > Clear Alarm.**
- Step 2** Select the name of the device whose alarms are to be cleared, click **Submit**, and choose **All, Locally synchronized alarms, or Alarms stored on devices** to clear alarms.

NOTE

If alarms are cleared for the SmartLogger, you must reset alarms on the management system. Otherwise, the management system cannot obtain the alarm information collected by the SmartLogger after the alarms are cleared.

----End

8.12 How Do I Enable the AI1 Port to Detect SPD Alarms?

Context

In the smart array controller application scenario, the AI1 port on the SmartLogger can be connected to the SPD alarm output to raise an alarm when the SPD is faulty.

Procedure

Step 1 Choose **Settings > Other Parameters** and set **AI1 SPD detection alarm** to **Enable**.

----End

8.13 Which Models of Power Meters and EMIs Are Supported by the SmartLogger?

Table 8-1 Supported power meters

Vendor	Model	Export Limitation
ABB	A44	N/A
Acrel	PZ96L	Supported
Algodue	UPM209	Supported NOTE When the power meter connects to the SmartLogger, an external 120-ohm resistor needs to be connected to the RS485 bus of the power meter. For details, see the user manual of the power meter.
CHNT	DTSU666	N/A
HUAWEI	DTSU666-H	Supported
Elster	A1800ALPHA	N/A
GAVAZZI	EM210	N/A
Janitza	UMG604/UMG103/ UMG104	Supported
Lead	LD-C83	N/A
MingHua	CRDM-830	N/A

Vendor	Model	Export Limitation
Mitsubishi	EMU4-BD1-MB	Supported NOTE <ul style="list-style-type: none"> • Not applicable to single-phase power scenarios. • When the power meter connects to the SmartLogger, an external 120-ohm resistor needs to be connected to the RS485 bus of the power meter. For details, see the user manual of the power meter.
Mitsubishi	ME110NSR-MB	N/A
Mitsubishi	ME110SR-MB	N/A
Mitsubishi	ME110SSR-MB	N/A
NARUN	PD510	N/A
Netbiter	CEWE	N/A
People	RM858E	N/A
REAL ENERGY SYSTEM	PRISMA-310A	N/A
Schneider	PM1200	N/A
Schneider	PM2xxx	N/A
Schneider	PM5100	N/A
Schneider	PM5300	N/A
SFERE	PD194Z	N/A
Socomec	COUNTIS E43	Supported NOTE <ul style="list-style-type: none"> • Not applicable to single-phase power scenarios. • When the power meter connects to the SmartLogger, an external 120-ohm resistor needs to be connected to the RS485 bus of the power meter. For details, see the user manual of the power meter.
Toshiba	S2MS	N/A
Wave Energy	PWM-72	N/A
WEG	MMW03-M22CH	N/A

 **NOTE**

The SmartLogger can connect to only one power meter that uses the Modbus-RTU protocol.

Table 8-2 Supported EMIs

Vendor	Model	EMI Information
ABB	VSN800-12	Total irradiance, ambient temperature, and PV module temperature
	VSN800-14	Total irradiance, ambient temperature, PV module temperature, wind direction, and wind speed
Gill MetPak Pro	Gill MetPak Pro	Total irradiance, ambient temperature, PV module temperature, wind direction, and wind speed
Hukseflux SRx	Hukseflux SRx	Total irradiance and ambient temperature
Ingenieurbüro Si-RS485TC	Ingenieurbüro Si-RS485TC	Total irradiance, ambient temperature, PV module temperature, and wind speed
Kipp&Zonen	SMPx series	Total irradiance and ambient temperature
Lufft	WSx-UMB	Total irradiance, ambient temperature, wind direction, and wind speed
	WSx-UMB(external sensors)	Total irradiance, ambient temperature, PV module temperature, wind direction, and wind speed
Meier-NT ADL-SR	Meier-NT ADL-SR	Total irradiance, ambient temperature, PV module temperature, and wind speed
MeteoControl	SR20-D2	Total irradiance and ambient temperature

Vendor	Model	EMI Information
RainWise	PVmet-150	Total irradiance, ambient temperature, and PV module temperature
	PVmet-200	Total irradiance, ambient temperature, PV module temperature, wind direction, and wind speed
Soluzione Solare	SunMeter	Total irradiance and ambient temperature
JinZhou LiCheng	JinZhou LiCheng	Total irradiance, ambient temperature, PV module temperature, wind direction, and wind speed
JinZhou YangGuang	PC-4	Total irradiance, ambient temperature, PV module temperature, wind direction, and wind speed
HanDan	RYQ-3	Total irradiance, ambient temperature, PV module temperature, wind direction, and wind speed
Sensor ADAM NOTE The sensor-type EMI (current-type or voltage-type) communicates with the SmartLogger through the ADAM analog-to-digital converter.	N/A	N/A

8.14 How Do I Check the SIM Card Status?

Choose **Over View** > **Mobile Data** to view the SIM card status.

Table 8-3 SIM card status

Parameter	Status	Description
4G module status	Card absent	No SIM card is detected. Insert a SIM card.

Parameter	Status	Description
	Failed to register the card.	<ol style="list-style-type: none"> 1. Check whether the SIM card account is in arrears. If yes, top up the account. 2. Check whether the network quality is poor. If yes, use a SIM card of another carrier with good signal quality. 3. Check whether the SIM card has been bound to another device. If yes, unbind the SIM card from the device or replace the SIM card.
	<ul style="list-style-type: none"> • Not connected • The card is in position. 	The SmartLogger is trying to set up a dial-up connection. Wait for the connection to be set up.
	Connected	The dial-up connection is set up successfully.
	Enter the PIN.	The SIM card has been set to require a personal identification number (PIN). Contact the carrier of the SIM card for the PIN, choose Settings > Wireless Network , and enter the correct PIN.
	Enter the PUK.	If the number of incorrect PIN attempts exceeds the upper limit, you need to enter the PIN unblocking key (PUK). Contact the carrier of the SIM card for the PUK. Choose Settings > Wireless Network and enter the correct PUK.
Traffic status	Normal	The used traffic does not exceed the monthly traffic package, and the remaining traffic is sufficient.
	Warning	The used traffic exceeds 80% of the monthly traffic package, and the remaining traffic is insufficient.
	Used up	The used traffic exceeds the monthly traffic package. Traffic is used up. Top up the SIM card account immediately.
	No package configured	Choose Settings > Wireless Network and configure a monthly traffic package.

8.15 How Do I Use Mobile Network Sharing?

Remotely Accessing the WebUI over a Mobile Network

NOTE

A 4G SmartLogger supports remote access to the SmartLogger WebUI over the built-in 4G wireless communication.

- Step 1** Insert a SIM card with a fixed IP address into the SIM card slot of the SmartLogger. Choose **Over View > Mobile Data** to check the SIM card status and ensure that the 4G wireless communication is normal.
- Step 2** Choose **Settings > Other Parameters** and set **Mobile network sharing** to **Enable**.

Figure 8-6 Other Parameters



- Step 3** Open a web browser, enter <https://XX.XX.XX.XX> (XX.XX.XX.XX is the fixed IP address of the SIM card) in the address box, and press **Enter**. The login page is displayed.

----End

Sharing a Mobile Network with Other Devices

NOTE

A 4G SmartLogger supports the sharing of the built-in 4G network with other devices for Internet access.

- Step 1** Connect the network cable of another device to the WAN port of the SmartLogger.
- Step 2** Choose **Settings > Other Parameters** and set **Mobile network sharing** to **Enable**.

Figure 8-7 Other Parameters

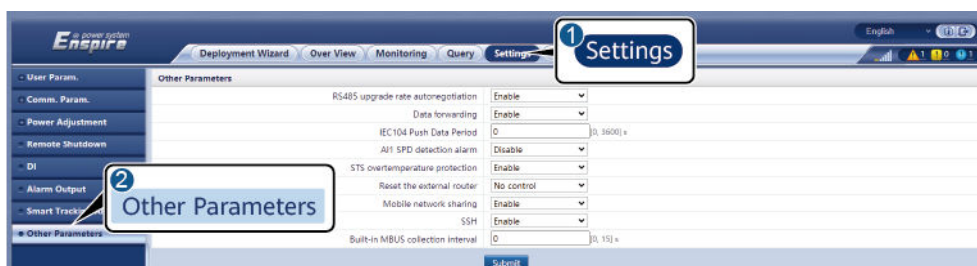

- Step 3** Set network parameters for third-party devices. (To query the network parameters of the SmartLogger, choose **Settings** > **Wired Network**.)

Figure 8-8 Setting wired network parameters

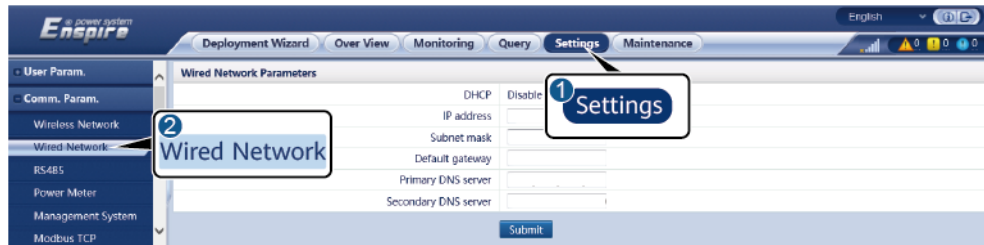

1. IP address of the third-party device: This parameter must be in the same network segment as that of the SmartLogger and must be different from that of other devices.
2. Subnet mask of the third-party device: Set this parameter to the subnet mask of the SmartLogger.
3. Third-party device gateway: Set this parameter to the IP address of the SmartLogger.
4. (Optional) Third-party DNS server: If the third-party device needs to connect to the server address in domain name format, you need to set the DNS server address, which can be set to a public DNS server address, for example, 8.8.8.8. (The DNS server address of the wired network of the SmartLogger with mobile network sharing enabled cannot be the same as that of the third-party device. You are advised to set the DNS server address to 0.0.0.0 or 10.129.0.84.)

----End

9 Technical Specifications

9.1 Technical Specifications of the SmartLogger

Device Management

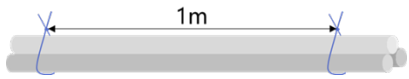
Parameter	Specifications
Number of solar inverters	<ul style="list-style-type: none"> SmartLogger3000A: can connect to a maximum of 80 solar inverters. SmartLogger3000B: can connect to a maximum of 150 solar inverters.
Communications mode	RS485, ETH, MBUS (optional), 4G (optional), and SFP (optional)
Maximum communication distance	<ul style="list-style-type: none"> RS485: 1000 m ETH: 100 m MBUS (multi-core cable): 1000 m; MBUS (single-core cable): 400 m (The three-phase cables must be bound at 1 m intervals)  <ul style="list-style-type: none"> Optical fiber (single-mode, 1310 nm optical module): 10,000 m (with the 1000M optical module); 12,000 m (with the 100M optical module)

Common Specifications

Parameter	Specifications
Power adapter	<ul style="list-style-type: none"> AC input: 100–240 V, 50/60 Hz DC output: 12 V, 2 A
DC power supply	24 V, 0.8 A
Power consumption	<ul style="list-style-type: none"> SmartLogger3000A: 8 W (typical) SmartLogger3000B: 9 W (typical) SmartLogger3000B + SmartModule1000A: 10 W (typical) 15 W (maximum)
Dimensions (W x H x D)	<ul style="list-style-type: none"> 259 mm x 160 mm x 59 mm (including mounting ears) 225 mm x 160 mm x 44 mm (excluding mounting ears)
Net weight	2 kg
Operating temperature	–40°C to +60°C
Storage temperature	–40°C to +70°C
Relative humidity	5%–95% RH
IP rating	IP20
Installation mode	Installed on a wall or guide rail
Highest operating altitude	4000 m
Pollution degree	2
Corrosion level	Class B

Ports

Parameter	Specifications
Ethernet electrical port (WAN and LAN)	2 PCS; 10M/100M/1000M auto-negotiation
Ethernet optical port (SFP)	2 PCS; supports 100M/1000M SFP/eSFP optical modules
MBUS port	1 PCS; supports an AC input voltage of 800 V at most
RS485 (COM) port	3 PCS; supported baud rates: 1200 bit/s, 2400 bit/s, 4800 bit/s, 9600 bit/s, 19,200 bit/s, and 115,200 bit/s

Parameter	Specifications
USB port	USB2.0
Power output port	1 PCS; DC output: 12 V, 0.1 A
Digital input (DI) port	4 PCS; supports only the access from relay dry contacts
Digital output (DO) port	2 PCS; relay dry contact output ports, supporting NO or NC contacts; supports 12 V, 0.5 A signal voltage
Analog input (AI) port	4 PCS; AI1: supports 0–10 V voltage (passive); AI2–AI4: support 4–20 mA or 0–20 mA input current (passive)
4G antenna port (4G)	1 PCS; SMA-K (external screw inner hole) port, used with the antenna with the SMA-J (internal screw inner pin) port

Wireless Communication

Parameter	Specifications
4G/3G/2G	<p>The SmartLogger3000A01CN supports 2G, 3G, and 4G networks of China Mobile and China Unicom as well as 4G networks of China Telecom.</p> <p>The following frequency bands are supported:</p> <ul style="list-style-type: none"> ● LTE FDD: B1, B3, B8 ● LTE TDD: B38, B39, B40, B41 ● WCDMA: B1, B5, B8, B9 ● TD-SCDMA: B34, B39 ● GSM: 900 MHz/1800 MHz <p>The SmartLogger3000A01EU and SmartLogger3000A03EU support the following frequency bands:</p> <ul style="list-style-type: none"> ● LTE FDD: B1, B3, B5, B7, B8, B20 ● LTE TDD: B38, B40, B41 ● WCDMA: B1, B5, B8 ● GSM: 900 MHz/1800 MHz

Parameter	Specifications
	<p>SmartLogger3000A01NH: Supports 3G/4G of Docomo and SoftBank.</p> <p>The following frequency bands are supported:</p> <ul style="list-style-type: none"> • LTE FDD: B1, B3, B8, B18, B19, B26 (only Tokyo, Nagoya, and Osaka support B3) • LTE TDD: B41 • WCDMA: B1, B6, B8, B19
	<p>The SmartLogger3000A01KR supports networks of SK Telecom.</p> <p>The following frequency bands are supported:</p> <ul style="list-style-type: none"> • LTE FDD: B1, B3, B5, B7 • WCDMA: B1
	<p>The SmartLogger3000A01AU supports the following frequency bands:</p> <ul style="list-style-type: none"> • LTE FDD: B1, B2, B3, B4, B5, B7, B8, B28 • LTE TDD: B40 • WCDMA: B1, B2, B5, B8 • GSM: 850MHz/900 MHz/1800 MHz/1900MHz
WLAN (local maintenance using app)	2.4G

RF Bands of the 4G Module (SmartLogger3000A01EU and SmartLogger3000A03EU)

Frequency Band	Tx	Rx
WCDMA Band 1	1920–1980 MHz	2110–2170 MHz
WCDMA Band 5	824–849 MHz	869–894 MHz
WCDMA Band 8	880–915 MHz	925–960 MHz
GSM 900	880–915 MHz	925–960 MHz
GSM 1800	1710–1785 MHz	1805–1880 MHz
LTE Band 1	1920–1980 MHz	2110–2170 MHz
LTE Band 3	1710–1785 MHz	1805–1880 MHz
LTE Band 5	824–849 MHz	869–894 MHz

Frequency Band	Tx	Rx
LTE Band 7	2500–2570 MHz	2620–2690 MHz
LTE Band 8	880–915 MHz	925–960 MHz
LTE Band 20	832–862 MHz	791–821 MHz
LTE Band 38	2570–2620 MHz	
LTE Band 40	2300–2400 MHz	
LTE Band 41	2555–2655 MHz	

Output Power of the 4G Module (SmartLogger3000A01EU and SmartLogger3000A03EU)

Frequency Band		Standard Value (Unit: dBm)	Remarks (Unit: dB)
GSM 900	GMSK (1Tx Slot)	33	±2
	8PSK (1Tx Slot)	27	±3
GSM 1800	GMSK (1Tx Slot)	30	±2
	8PSK (1Tx Slot)	26	±3
WCDMA Band 1		24	+1/-3
WCDMA Band 5		24	+1/-3
WCDMA Band 8		24	+1/-3
LTE Band 1		23	±2
LTE Band 3		23	±2
LTE Band 5		23	±2
LTE Band 7		23	±2
LTE Band 8		23	±2
LTE Band 20		23	±2
LTE Band 38		23	±2
LTE Band 40		23	±2
LTE Band 41		23	±2

WLAN

Parameter	Specifications
Frequency band	2.4 GHz: 2.4–2.4835 GHz
Gain	2.4 GHz: 2.85 dBi
Transmit power	2.4 GHz: 1 x 100 mW
Maximum throughput	2.4 GHz: 65 Mbit/s
Single/Dual band mode	Single
MIMO	2.4 GHz frequency band: 1T1R
Maximum number of online users	6
Polarization mode	Linear
Directivity	Multi-dimensional

9.2 Technical Specifications of the SmartModule

Device Management

Parameter	Specifications
Communications mode	RS485, ETH
Maximum communication distance	<ul style="list-style-type: none"> ● RS485:1000 m ● ETH: 100 m

Common Specifications

Parameter	Specifications
DC power supply	<ul style="list-style-type: none"> ● DC 12 V: DC 2.0 power socket male connector ● DC 24 V: cord end terminal
Power consumption	Typical: 4 W; maximum: 5 W
Dimensions (H x W x D)	<ul style="list-style-type: none"> ● Including mounting ears: 160 mm x 179 mm x 59 mm ● Without mounting ears: 160 mm x 125 mm x 44 mm
Net weight	1 kg
Operating temperature	-40°C to +60°C

Parameter	Specifications
Storage temperature	-40°C to +70°C
Humidity	5%–95% RH
Ingress protection rating	IP20
Installation mode	Installed on a wall or guide rail
Maximum operating altitude	4000 m
Pollution level	Level 2
Corrosion level	Class B

Ports

Parameter	Specifications
Ethernet electrical port (GE)	4 PCS; 10M/100M/1000M auto-negotiation
RS485 port (COM)	3 PCS; supported baud rates: 1200 bit/s, 2400 bit/s, 4800 bit/s, 9600 bit/s, 19,200 bit/s, and 115,200 bit/s
Power output port	1 PCS; DC output: 12 V, 0.1 A
Digital input (DI) port	4 PCS; supports only the access from relay dry contacts
PT port (PT)	Two PCS; supports the access of signals from a 3-wire or 2-wire PT100/PT1000 temperature sensor
Analog input (AI) port	4 PCS; AI1: supports 0–10 V voltage (passive); AI2–AI4: support 4–20 mA or 0–20 mA input current (passive)

A Product User Lists

Table A-1 User list

Login Mode	User Name	Initial Password
App	installer	00000a
	user	00000a
WebUI	admin	Changeme

Table A-2 Second challenge authentication

Authentication Mode	User Name	Initial Password
SmartLogger authentication by the management system	emscomm	/EzFp+2%r6@IxSCv
SmartModule authentication by the SmartLogger	SmoduleAdmin	/EzFp+2%r6@IxSCv

Table A-3 Operating system user list

User Name	Initial Password
enspire	Changeme
root	Changeme
prorunacc	No initial password

User Name	Initial Password
bin	No initial password
daemon	No initial password
nobody	No initial password
sshd	No initial password

B Domain Name List of Management Systems

 **NOTE**

The list is subject to change.

Table B-1 Domain names of management systems

Domain Name	Data Type	Scenario
intl.fusionsolar.huawei.com	Public IP address	FusionSolar hosting cloud NOTE The domain name is compatible with cn.fusionsolar.huawei.com (Chinese mainland).
neteco.alsoenergy.com	Public IP address	Partner management system
re-ene.kyuden.co.jp	Public IP address	Remote output control server of Kyushu Electric Power Company
re-ene.yonden.co.jp	Public IP address	Remote output control server of Shikoku Electric Power Company

C Port No. List

Table C-1 Port No.

Type of Connected Access Management	Management System Setting Port No.	Open Port No. of Router (Firewall)	Remarks
NetEco	16100	16100, 2121, 11000–11500	<ul style="list-style-type: none">• 16100: used to query and set data between the SmartLogger and the management system.• 2121 and 11000–11500: used to upload and download data or files between the SmartLogger and the management system using FTPS.
FusionSolar Smart PV Hosting Cloud Center	16100	16100, 2121, 50000–55000	<p>The device performance data is updated in real time. Each device requires 3 MB traffic per day.</p> <ul style="list-style-type: none">• 16100: used to query and set data between the SmartLogger and the management system.• 2121 and 50000–55000: used to upload and download data or files between the SmartLogger and the management system using FTPS.

Type of Connected Access Management	Management System Setting Port No.	Open Port No. of Router (Firewall)	Remarks
	27250	27250, 27251, 2122, 55000–56000	<p>Traffic-saving port. This port is recommended when the SmartLogger connects to the management system in wireless mode. The device performance data is updated every 5 minutes.</p> <ul style="list-style-type: none">• 27250 and 27251: used to query and set data between the SmartLogger and the management system.• 2122 and 55000–56000: used to upload and download data or files between the SmartLogger and the management system using FTPS.

 **NOTE**

- If a third-party management system connects to the SmartLogger over Modbus TCP, the SmartLogger port No. is 502, which is used to query and set data between the SmartLogger and the third-party management system.
- If a third-party management system connects to the SmartLogger over IEC104, the SmartLogger port No. is 2404, which is used to query and set data between the SmartLogger and the third-party management system.
- If the SmartLogger connects to a third-party FTP server over FTP, the common port No. is 21, which is used to periodically upload performance data to the third-party FTP server.
- If the SmartLogger connects to a third-party email server over SMTP, the common port No. is 25, 465, or 587, which is used to send emails to the email server.
- If the SmartLogger connects to a third-party NTP server over NTP, the common port No. is 123, which is used for time synchronization with the NTP server.
- If the SmartLogger connects to a remote output server of Japan Electric Power Company over HTTPS, the common port No. is 443, which is used to synchronize the scheduling table with the electric power company.

D Acronyms and Abbreviations

A

AC Alternating Current

AI Analog Input

AO Analog Output

App Application

C

COM Communication

CPE Customer Premises
Equipment

D

DC Direct Current

DI Digital Input

DO Digital Output

E

EMI Environmental Monitoring
Instrument

ETH	Ethernet
G	
GE	Gigabit Ethernet
GND	Ground
L	
LAN	Local Area Network
LED	Light-emitting Diode
LTE	Long Term Evolution
M	
MBUS	Monitoring bus
N	
NC	Normally Closed
NO	Normally Open
P	
POE	Power over Ethernet
R	
RST	Reset
RSTP	Rapid Spanning Tree Protocol
S	

SFP	Small Form-factor Pluggable
STP	Spanning Tree Protocol
U	
USB	Universal Serial Bus
W	
WAN	Wide Area Network
WEEE	Waste Electrical and Electronic Equipment