

Installation Manual
485 Data Module Type B

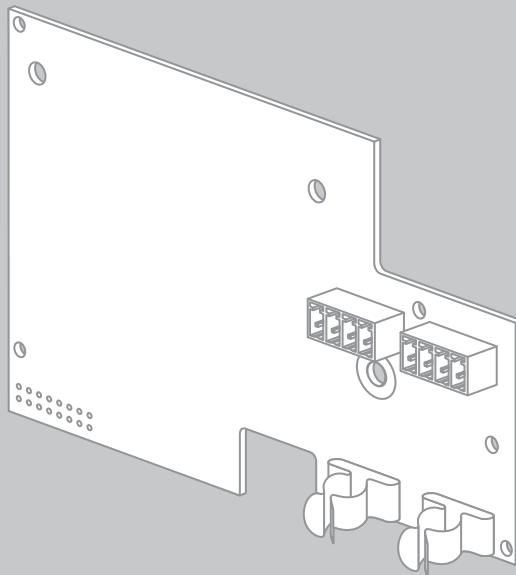

Legal Provisions

The information contained in this document is the property of SMA Solar Technology AG. Publishing its content, either partially or in full, requires the written permission of SMA Solar Technology AG. Any internal company copying of the document for the purposes of evaluating the product or its correct implementation is allowed and does not require permission.

SMA Warranty

You can download the current warranty conditions from the Internet at www.SMA-Solar.com.

Trademarks

All trademarks are recognized, even if not explicitly identified as such. A lack of identification does not mean that a product or symbol is not trademarked.

The BLUETOOTH® word mark and logos are registered trademarks owned by Bluetooth SIG, Inc. and any use of these marks by SMA Solar Technology AG is under license.

Modbus® is a registered trademark of Schneider Electric and is licensed by the Modbus Organization, Inc.

QR Code is a registered trademark of DENSO WAVE INCORPORATED.

Phillips® and Pozidriv® are registered trademarks of Phillips Screw Company.

Torx® is a registered trademark of Acument Global Technologies, Inc.

SMA Solar Technology AG

Sonnenallee 1
34266 Niestetal
Germany

Tel. +49 561 9522-0

Fax +49 561 9522-100

www.SMA.de

E-mail: info@SMA.de

© 2004 to 2014 SMA Solar Technology AG. All rights reserved.

Table of Contents

1	Information on this Document	5
1.1	Validity	5
1.2	Target Group	5
1.3	Additional Information	5
1.4	Symbols	5
1.5	Typography	6
1.6	Nomenclature	6
2	Safety	7
2.1	Appropriate Usage	7
2.2	Safety Precautions	8
3	Scope of Delivery	9
4	Product Description	10
4.1	485 Data Module	10
4.2	Type Label	10
5	Electrical Connection	11
5.1	Safety during Electrical Connection	11
5.2	Mounting Position and Cable Routing	12
5.3	Installing the 485 Data Module in the Inverter	13
5.4	Preparing the Cables	14
5.5	Preparing the Cable Gland on the Inverter	15
5.6	Connecting the Cables to the 485 Data Module	17
6	Troubleshooting	19
7	Decommissioning	20
7.1	Disassembling the 485 Data Module	20
7.2	Packaging the 485 Data Module for Shipping	20
7.3	Disposing of the 485 Data Module	20
8	Technical Data	21
9	Contact	22

1 Information on this Document

1.1 Validity

This document is valid for the device type "485BRD-10" (485 Data Module Type B).

1.2 Target Group

The tasks described in this document must be performed by qualified persons only. Qualified persons must have the following skills:





- Training in how to deal with the dangers and risks associated with installing and using electrical devices and plants
- Training in the installation and commissioning of electrical devices and plants
- Knowledge of all applicable standards and directives
- Knowledge of how an inverter works and is operated
- Knowledge of and compliance with this document and all the safety precautions

1.3 Additional Information

Links to additional information can be found at www.SMA-Solar.com:

Document title	Document type
RS485 Cabling Plan	Technical description

1.4 Symbols

Symbol	Explanation
 DANGER	Indicates a hazardous situation which, if not avoided, will result in death or serious injury
 WARNING	Indicates a hazardous situation which, if not avoided, could result in death or serious injury
 CAUTION	Indicates a hazardous situation which, if not avoided, could result in minor or moderate injury
NOTICE	Indicates a situation which, if not avoided, could result in property damage
	Information that is important for a specific topic or goal, but is not safety-relevant
<input type="checkbox"/>	Indicates an essential requirement for achieving a specific goal
<input checked="" type="checkbox"/>	Desired result
x	A problem that might occur

1.5 Typography

Typography	Explanation	Example
bold	<ul style="list-style-type: none"> • Display texts • Elements of a user interface • Terminals • Elements to be selected • Elements to be entered 	<ul style="list-style-type: none"> • The value can be read from the Energy field. • Select Settings. • Enter the value 10 in the Minutes field.
>	<ul style="list-style-type: none"> • Connects several elements to be selected 	<ul style="list-style-type: none"> • Select Settings > Date.
[Button/Key]	<ul style="list-style-type: none"> • Button or key to be selected or pressed 	<ul style="list-style-type: none"> • Select [Next].

1.6 Nomenclature

In this document, the "485 Data Module Type B" is referred to as "485 data module".

2 Safety

2.1 Appropriate Usage

The 485 data module enables you to setup cable-connected RS485 communication.

The 485 data module can be retrofitted, or installed in the inverter at the factory if specified in the order.

The inverter still complies with the standard after the product has been installed.

The 485 data module is suitable for installation in the following SMA inverters:

Sunny Tripower	Windy Tripower
STP 5000TL-20	WTP 5000TL-20
STP 6000TL-20	WTP 6000TL-20
STP 7000TL-20	WTP 7000TL-20
STP 8000TL-20	WTP 8000TL-20
STP 9000TL-20	WTP 9000TL-20
STP 10000TL-20	
STP 12000TL-20	

Use this product only in accordance with the information provided in the enclosed documentation and with the locally applicable standards and directives. Any other use may result in personal injury or property damage.

For safety reasons, it is not permitted to modify the product or install components that are not explicitly recommended or distributed by SMA Solar Technology AG for this product.

The enclosed documentation is an integral part of this product.

- Read and observe the documentation.
- Keep the documentation in a convenient place for future reference.

2.2 Safety Precautions

This section contains safety precautions that must be observed at all times when working on or with the product.

To prevent personal injury or property damage and to ensure long-term operation of the product, read this section carefully and follow the safety precautions at all times.

⚠ WARNING

Electric shock due to live voltage

High voltages that can cause fatal electric shocks are present in the live components of the inverter.

- Prior to performing any work on the inverter, always disconnect the inverter from any voltage sources as described in the corresponding installation manual (see inverter installation manual).

⚠ CAUTION

Risk of burns due to hot enclosure parts

Some parts of the inverter enclosure can get hot during operation.

- During operation, touch the inverter on the enclosure lid and the protective cover only.

NOTICE

Damage to the 485 data module or the inverter due to electrostatic discharge

Touching electronic components on the 485 data module or in the inverter can cause damage to or destroy the 485 data module and the inverter through electrostatic discharge.

- Earth yourself before touching any components.
- Avoid any contact with components and plug contacts.

3 Scope of Delivery

Check the scope of delivery for completeness and any externally visible damage. Contact your specialist dealer if the delivery is incomplete or damaged.

If the 485 data module has already been installed in the inverter at the factory, only those parts necessary for electrical connection are included in the scope of delivery.

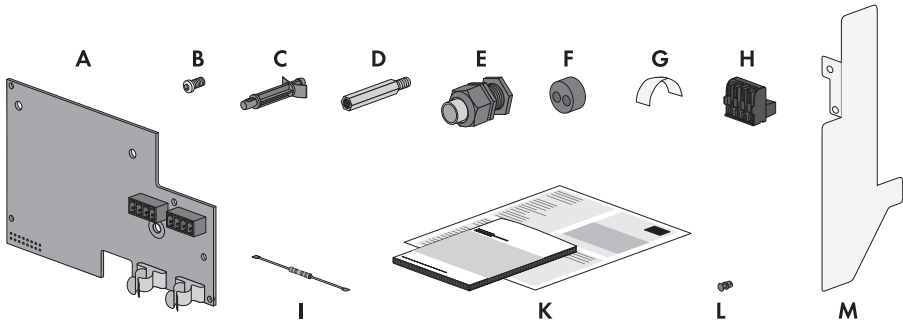

Figure 1: Components included in the scope of delivery

Item	Number	Designation
A	1	485 data module
B	1	M4x10 screw
C	2	Plastic spacer
D	1	Metal spacer
E	1	M25 cable gland with sealing plug, cable support sleeve with one hole and M25 counter nut
F	1	Cable support sleeve with two holes for M25 cable gland
G	2	Copper foil
H	2	Spring-cage connector
I	1	Terminator
K	1	Installation manual, RS485 cabling plan
L	1	Expanding rivet
M	1	Plastic foil for isolating the communication connection from the AC connection

4 Product Description

4.1 485 Data Module

The 485 data module enables you to setup cable-connected RS485 communication.

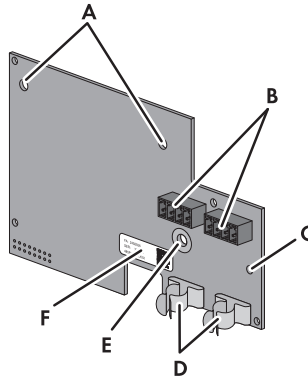

Item	Designation
A	Holes for attaching the data module using the plastic spacers
B	Sockets to plug in the spring clamp terminals
C	Hole for attaching the plastic foil
D	Shield clamps
E	Hole for attaching the data module using the metal spacer
F	Type label

4.2 Type Label

The type label clearly identifies the 485 data module. The type label is located on the front of the 485 data module.

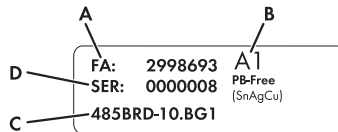

Figure 2: Layout of the type label (example)

Item	Explanation
A	Number of the production order
B	Version of the 485 data module
C	Device type
D	Serial number

You require the information on the type label for customer support from the SMA Service Line. The type label must remain permanently attached to the 485 data module.

5 Electrical Connection

5.1 Safety during Electrical Connection

⚠ DANGER**Danger to life due to electric shock**

High voltages that can cause fatal electric shocks are present in the live components of the inverter.

- Prior to performing any work on the inverter, always disconnect the inverter from any voltage sources as described in the corresponding installation manual (see inverter installation manual).

NOTICE**Damage of components due to electrostatic discharge**

Touching electronic components on the module or in the inverter can cause damage to or destroy the module and the inverter through electrostatic discharge.

- Earth yourself before touching any components.
- Avoid any contact with components and plug contacts.

5.2 Mounting Position and Cable Routing

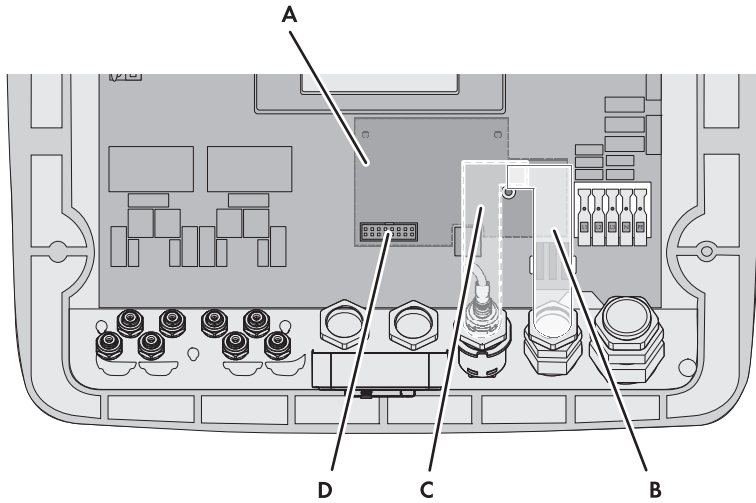
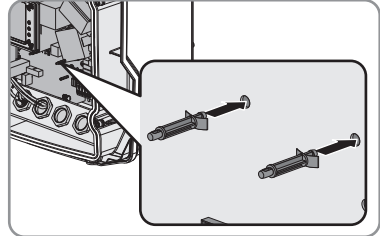

Figure 3: Mounting position and cable route in the inverter with the enclosure lid open

Item	Designation
A	Mounting position
B	Cable route
C	Optional cable route
D	Socket to plug in the 485 data module

5.3 Installing the 485 Data Module in the Inverter

1. Disconnect the inverter from voltage sources on the AC and DC sides and open it (see the inverter installation manual).
2. Attach all spacers in the inverter.
 - Insert the plastic spacers into the holes.



- Screw the metal spacer into the screw connection (torque: $3.5 \text{ Nm} \pm 0.3 \text{ Nm}$).

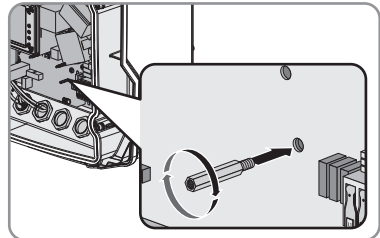

3. Insert the module in the inverter. Position the plug at the bottom of the 485 data module in the socket and lead the spacers through the holes in the 485 data module.

The 485 data module audibly clicks into place.

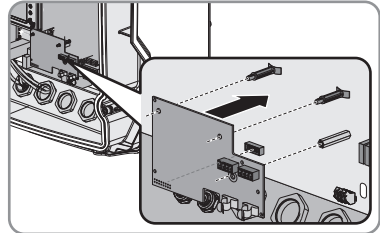

4. Fasten the 485 data module using the screw M4x10 and a Torx screwdriver (T 20) (torque: $3.5 \text{ Nm} \pm 0.3 \text{ Nm}$).

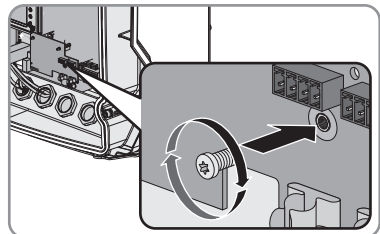

5.4 Preparing the Cables

i Disturbance of data transmission due to AC cables

During operation, AC cables generate an electromagnetic field which may induce interference in plant communication.

- Do not lay the cables of the RS485 communication together with the AC cable.

Requirement:

- The cable requirements are complied with (see Technical Description "RS485 Cabling Plan").
- Diameter of the cable when using the cable support sleeve with one hole: at maximum 17 mm
- Diameter of the cable when using the cable support sleeve with two holes: at maximum 6.5 mm

Depending on whether the inverter is located at the end or in the middle of the communication bus, prepare one or two cables as described in the following:

1. Remove 40 mm of the cable sheath at the end of the cable to be connected to the 485 data module.
2. Shorten the cable shield to 15 mm.
3. Fold the surplus cable shield back onto the cable sheath.

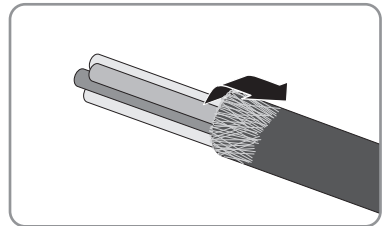

4. Wrap the cable shield with copper foil.

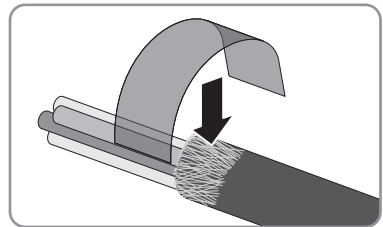

5. Strip the insulation on the three wires each by 6 mm. Two wires for communication must be a twisted pair.
6. Shorten all other wires flush with the cable sheath.

5.5 Preparing the Cable Gland on the Inverter

In order to prepare the cable gland on the inverter, you have to know whether one or two cables are to be connected to the 485 data module and whether the multi-function relay in the inverter is to be used immediately or at a later time.

If you wish to connect one or two cables to the 485 data module and do not want to use the multi-function relay in the inverter neither immediately nor at a later time, prepare the M25 cable gland on the inverter for one or two cables.

If you wish to connect two cables to the 485 data module and the multi-function relay in the inverter is used immediately or at a later time, you must remove the Ethernet socket from the inverter and mount another M25 cable gland on the inverter.

Preparing the Cable Gland on the Inverter for One or Two Cables

1. Unscrew the swivel nut from the M25 cable gland and push out the sealing plug.
2. If one cable is to be connected, remove the cable support sleeve with one hole from the M25 cable gland and insert the cable into the one-hole cable support sleeve.
3. If two cables are to be connected, remove the cable support sleeve with one hole from the M25 cable gland and insert the cables into the supplied two-hole cable support sleeve.

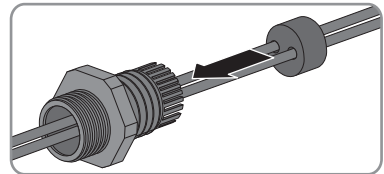

4. Press the cable support sleeve into the cable gland and lead each cable all the way up to the sockets on the 485 data module.
5. Screw the swivel nut onto the M25 cable gland.
6. Remove the protective cover of the multi-function relay from the inside of the inverter.
The protective cover is no longer required.

Mounting and Preparing the Supplied Cable Gland on the Inverter

1. Remove the plug from the Ethernet socket.

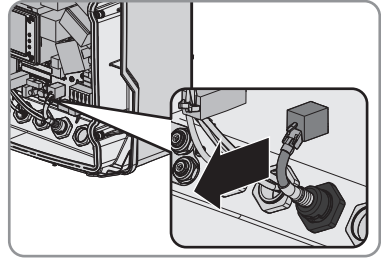

2. Unscrew the Ethernet socket from the enclosure opening.

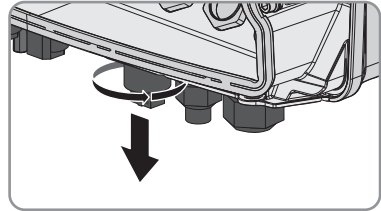

3. Insert the supplied M25 cable gland in the enclosure opening and tighten it from the inside using the counter nut (torque: $3.5 \text{ Nm} \pm 0.3 \text{ Nm}$).

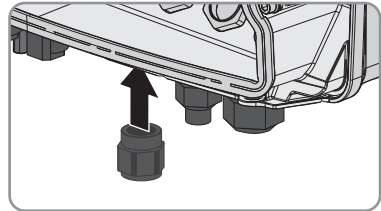

4. Unscrew the swivel nut from the cable gland and remove the sealing plug from the cable gland.
5. Remove the cable support sleeve with one hole from the M25 cable gland and insert the cables into the supplied cable support sleeve with two holes.

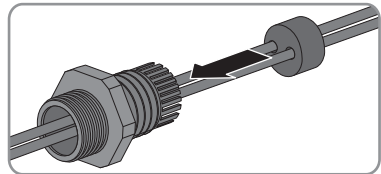

6. Press the cable support sleeve into the cable gland and lead each cable all the way up to the sockets on the 485 data module.
7. Screw the swivel nut onto the M25 cable gland.
8. Remove the protective cover of the multi-function relay from the inside of the inverter. The protective cover is no longer required.

5.6 Connecting the Cables to the 485 Data Module

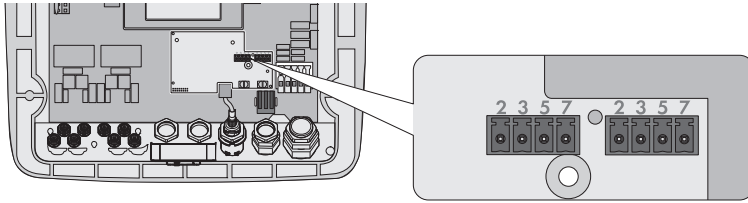
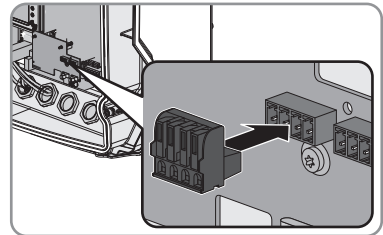

Figure 4: Overview of the connection area

Connect each cable to the 485 data module according to the following procedure.

1. Plug one spring-cage connector into each of the sockets on the 485 data module.



2. If one cable is to be connected, attach the terminator:
 - Push the levers of the terminals 2 and 7 of one spring-cage connector upwards.
 - Bend the ends of the terminator downwards and plug the terminator into the open terminals.
 - Push the levers back down.

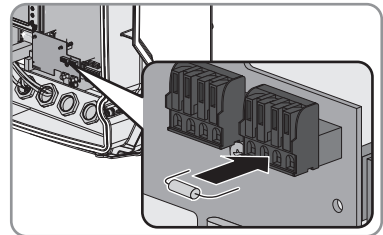

3. Push the levers of the terminals 2, 5 and 7 of one spring-cage connector upwards.

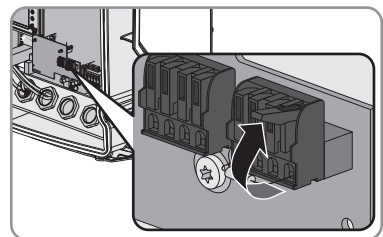

4. Connect the wire to the terminals of the spring clamp terminal and note down the colour of the wires. The cables can be allocated to any spring-cage connector.

	Signal	485 data modules	Insulated wire colour	RS485 bus
	GND	5		5
	Data+	2		2
	Data-	7		7

5. Close the spring clamp terminals.

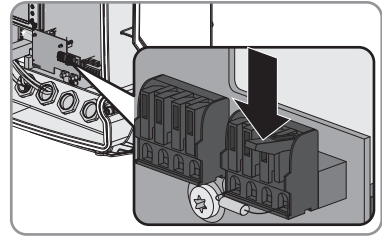

6. Press each cable with the cable shield into the shield clamp.

7. **⚠ WARNING**

Electric shock due to live cables

If, during inverter operation, an insulated wire (L1, L2 or L3) should become detached from the AC terminal, there is the risk that the cables of the RS485 communication become live. Touching the cables can cause fatal electric shock.

- Attach the supplied plastic foil to the module using the supplied expanding rivet. This isolates the AC connection area in the inverter from other terminals.

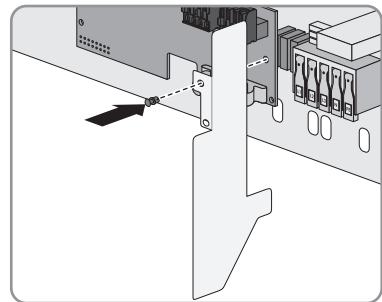

8. Tighten the swivel nut of the cable gland.
9. Close and commission the inverter (see inverter installation manual).
10. Connect the cable end to the RS485 bus (for information on the terminal assignment and wiring in the system, see the Technical Description "RS485 Cabling Plan").

6 Troubleshooting

Problem	Cause and corrective measures
<p>The emergency channel list "Emergency" or "EmgncyXX" is displayed in the communication product (e. g. Sunny WebBox, Sunny Explorer).</p> <p>The inverter is displayed with the device class "Other" in Sunny Portal.</p>	<p>The 485 data module has been installed in an inverter without first disconnecting the inverter on the AC and DC sides. This prevents the inverter from detecting the new 485 Data Module.</p> <p>Corrective measures:</p> <ul style="list-style-type: none"> • Prior to performing any work on the inverter, disconnect the inverter from any voltage sources on the AC and DC sides (see inverter installation manual). <hr/> <p>Several SMA communication products query data simultaneously from the devices via <i>Bluetooth</i> (e.g. Sunny Explorer, Sunny Beam with <i>Bluetooth</i>) and RS485 communication (e.g. Sunny WebBox).</p> <p>This can cause data congestion if a lot of data is transmitted simultaneously. If this state lasts for more than five minutes, the inverter carries out a reset of the 485 data module. Due to the data congestion, the inverter cannot detect the 485 data module after the reset.</p> <p>Corrective measures:</p> <ul style="list-style-type: none"> • Wait until the inverter restarts the next morning, then the inverter will detect the 485 data module. <p>or</p> <p>Disconnect the inverter from voltage sources on the AC and DC sides and recommission it (see the inverter installation manual).</p> <hr/>

7 Decommissioning

7.1 Disassembling the 485 Data Module

1. Disconnect the inverter from voltage sources on the AC and DC sides and open it (see the inverter installation manual).
2. Open the spring clamp terminals of the plug at the 485 data module.
3. Remove the wires from the plug.
4. Slightly loosen the swivel nut of the cable gland and remove the cable support sleeve.
5. Remove each cable from the inverter and from the cable support sleeve.
6. Unscrew the screw M4x10 to which the 485 data module is attached to the inverter using a Torx screwdriver (T 20).

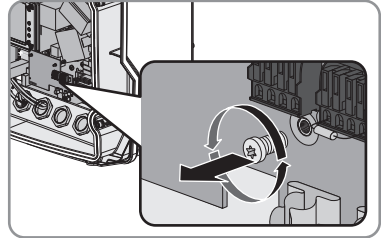

7. Remove the 485 data module from the inverter. The spacers remain in the inverter.

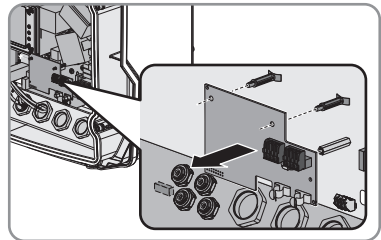

8. Insert the sealing plug into the cable gland. This ensures that the inverter complies with its degree of protection.
9. Tighten the swivel nut of the cable gland.
10. Close and commission the inverter (see inverter installation manual).

7.2 Packaging the 485 Data Module for Shipping

- Pack the 485 data module. Use the original packaging or packaging that is suitable for the weight and size of the 485 data module.

7.3 Disposing of the 485 Data Module

- Dispose of the 485 data module in accordance with the regulations for the disposal of electronic waste applicable at the installation site.

8 Technical Data

Mechanical Data

Dimensions (width x height x depth)	127 mm x 77 mm x 39 mm
Weight	47 g

Communication

Communication interface	RS485
Maximum cable length	1,200 m

Connections

Type of plug	4-pole spring clamp terminal
Number of RS485 terminals	2

Ambient Conditions during Operation

Ambient temperature	- 25 °C to +85 °C
Relative humidity, non-condensing	5% to 95%
Maximum height above sea level (MSL)	3,000 m

Ambient Conditions for Storage/Transport

Ambient temperature	- 40 °C to +85 °C
Relative humidity, non-condensing	5% to 95%
Maximum height above MSL	3,000 m

9 Contact

If you have technical problems concerning our products, please contact the SMA Service Line. We require the following information in order to provide you with the necessary assistance:

- Serial number and firmware version of the inverter (tap twice on the inverter display or see Sunny Portal or Sunny Explorer)
- Special country-specific settings of the inverter (if applicable)
- Serial number and version of the 485 data module
- Type and serial number or version of the communication product (e.g., Sunny Explorer)
- Detailed description of the problem

Australia	SMA Australia Pty Ltd. Sydney	Toll free for Australia: International:	1800 SMA AUS (1800 762 287) +61 2 9491 4200
Belgien/ Belgique/ België	SMA Benelux BVBA/SPRL Mechelen	+32 15 286 730	
Brasil	Vide España (Espanha)		
Česko	SMA Central & Eastern Europe s.r.o. Praha	+420 235 010 417	
Chile	Ver España		
Danmark	Se Deutschland (Tyskland)		
Deutschland	SMA Solar Technology AG Niestetal	Medium Power Solutions Wechselrichter: Kommunikation: SMA Online Service Center: www.SMA.de/Service Hybrid Energy Solutions Sunny Island: PV-Diesel Hybridsysteme: Power Plant Solutions Sunny Central:	+49 561 9522-1499 +49 561 9522-2499 +49 561 9522-399 +49 561 9522-3199 +49 561 9522-299
España	SMA Ibérica Tecnología Solar, S.L.U. Barcelona	Llamada gratuita en España: Internacional:	900 14 22 22 +34 902 14 24 24
France	SMA France S.A.S. Lyon	Medium Power Solutions Onduleurs : Communication : Hybrid Energy Solutions Sunny Island : Power Plant Solutions Sunny Central :	+33 472 09 04 40 +33 472 09 04 41 +33 472 09 04 42 +33 472 09 04 43

India	SMA Solar India Pvt. Ltd. Mumbai	+91 22 61713888
Italia	SMA Italia S.r.l. Milano	+39 02 8934-7299
Κύπρος/ Kıbrıs	Βλέπε Ελλάδα/ Bkz. Ελλάδα (Yunanistan)	
Luxemburg/ Luxembourg	Siehe Belgien Voir Belgique	
Magyarország	lásd Česko (Csehország)	
Nederland	zie Belgien (België)	
Österreich	Siehe Deutschland	
Perú	Ver España	
Polska	Patrz Česko (Czechy)	
Portugal	SMA Solar Technology Portugal, Unipessoal Lda Lisboa	Isento de taxas em Portugal: Internacional: 800 20 89 87 +351 2 12 37 78 60
România	Vezi Česko (Cehia)	
Schweiz	Siehe Deutschland	
Slovensko	pozri Česko (Česká republika)	
South Africa	SMA Solar Technology South Africa Pty Ltd. Centurion (Pretoria)	08600 SUNNY (08600 78669) International: +27 (12) 643 1785
United Kingdom	SMA Solar UK Ltd. Milton Keynes	+44 1908 304899
Ελλάδα	SMA Hellas AE Αθήνα	801 222 9 222 International: +30 212 222 9 222
България	Вижте Ελλάδα (Γърция)	
ไทย	SMA Solar (Thailand) Co., Ltd. กรุงเทพฯ	+66 2 670 6999
대한민국	SMA Technology Korea Co., Ltd. 서울	+82 2 508-8599

+971 2 234-6177

SMA Middle East LLC

أبو ظبي

الإمارات
العربية المتحدة

Other countries	International SMA Service Line Niestetal	Toll free worldwide: 00800 SMA SERVICE (+800 762 7378423)
-----------------	---	--

SMA Solar Technology

www.SMA-Solar.com

