

SMA DATA MANAGER M

EDMM-20

Legal Provisions

The information contained in these documents is the property of SMA Solar Technology AG. No part of this document may be reproduced, stored in a retrieval system, or transmitted, in any form or by any means, be it electronic, mechanical, photographic, magnetic or otherwise, without the prior written permission of SMA Solar Technology AG. Internal reproduction used solely for the purpose of product evaluation or other proper use is allowed and does not require prior approval.

SMA Solar Technology AG makes no representations or warranties, express or implied, with respect to this documentation or any of the equipment and/or software it may describe, including (with no limitation) any implied warranties of utility, merchantability, or fitness for any particular purpose. All such representations or warranties are expressly disclaimed. Neither SMA Solar Technology AG nor its distributors or dealers shall be liable for any indirect, incidental, or consequential damages under any circumstances.

The exclusion of implied warranties may not apply in all cases under some statutes, and thus the above exclusion may not apply.

Passwords managed by this SMA product are always stored encrypted.

Specifications are subject to change without notice. Every attempt has been made to make this document complete, accurate and up-to-date. Readers are cautioned, however, that product improvements and field usage experience may cause SMA Solar Technology AG to make changes to these specifications without advance notice or per contract provisions. SMA Solar Technology AG shall not be responsible for any damages, including indirect, incidental or consequential damages, caused by reliance on the material presented, including, but not limited to, omissions, typographical errors, arithmetical errors or listing errors in the content material.

SMA Warranty

You can download the current warranty conditions from the Internet at www.SMA-Solar.com.

Software licenses

The licenses for the installed software modules (open source) can be found in the user interface of the product.

Trademarks

All trademarks are recognized, even if not explicitly identified as such. Missing designations do not mean that a product or brand is not a registered trademark.

SMA Solar Technology AG

Sonnenallee 1

34266 Niestetal

Germany

Tel. +49 561 9522-0

Fax +49 561 9522-100

www.SMA.de

E-mail: info@SMA.de

Status: Tuesday, October 8, 2024

Copyright © 2024 SMA Solar Technology AG. All rights reserved.

Table of Contents

1	Information on this Document.....	10
1.1	Validity	10
1.2	Target Group.....	10
1.3	Content and Structure of this Document	10
1.4	Levels of Warning Messages	10
1.5	Symbols in the Document	11
1.6	Typographies in the document	11
1.7	Designations in the Document	11
1.8	Additional Information	12
2	Safety	13
2.1	Intended Use	13
2.2	IMPORTANT SAFETY INSTRUCTIONS.....	14
3	Scope of delivery	16
4	Product overview	17
4.1	Device function.....	17
4.2	Product Description	18
4.3	Symbols on the Product	18
4.4	Reset button	19
4.5	LED Signals.....	20
4.6	Interfaces and Functions	21
4.6.1	Wi-Fi access point.....	21
4.6.2	SMA Speedwire	21
4.6.3	Modbus.....	21
4.6.4	SunSpec Modbus	22
4.6.5	User Interface.....	22
4.6.6	Sunny Portal	22
4.6.7	Dashboard	23
4.6.8	Plant-wide parameterization	23
4.6.9	Energy Monitoring.....	23
4.6.10	FTP push.....	23
4.6.11	SMA Smart Connected	23
4.6.12	Grid Management Services.....	23
4.6.13	Reactive Power Control	24
4.6.14	Zero export	24
4.6.15	Active Power Limitation.....	24
4.6.16	Direct selling.....	24
4.6.17	Device Key (DEV KEY)	24

5	Mounting	25
5.1	Requirements for Mounting	25
5.1.1	Requirements for the Mounting Location.....	25
5.1.2	Permitted and prohibited mounting positions.....	25
5.1.3	Dimensions for mounting	26
5.1.4	Recommended clearances for mounting.....	26
5.2	Mounting the Product on the DIN Rail.....	26
5.3	Mounting the Product on the Wall.....	27
6	Connection.....	28
6.1	Requirements for the Connection	28
6.1.1	Connection cable requirements for power supply terminal X1.....	28
6.1.2	Signal cable requirements for fast stop X2	28
6.1.3	Signal cable requirements for multifunction relay X3	28
6.1.4	Signal cable requirements for analog terminals X4 to X7	28
6.1.5	Signal cable requirements for temperature input X8.....	28
6.1.6	RS485 X9 cable requirements.....	28
6.1.7	Signal cable requirements for digital terminals X10 to X13	29
6.1.8	Network cable requirements X14 to X16	29
6.2	Overview of the Connection Area	29
6.3	Preparing the Connection Cable.....	30
6.4	Terminal for fast stop X2	31
6.4.1	Fast stop X2.....	31
6.4.2	PIN assignment X2	31
6.4.3	Circuitry overview X2	31
6.4.4	Connect switch for fast stop to X2	31
6.5	Connection to the multifunction relay X3.....	32
6.5.1	Digital output X3 (MFR).....	32
6.5.2	Pin assignment X3 (MFR)	32
6.5.3	Circuitry overview X3	33
6.5.4	Connecting signal source to X3.....	33
6.6	Connection to the analog output X4/X5.....	33
6.6.1	Analog outputs X4/X5	33
6.6.2	PIN assignment X4	34
6.6.3	PIN assignment X5	34
6.6.4	Circuitry overview X4/X5.....	34
6.6.5	Connecting the remote terminal to X4/X5	34
6.7	Connection to the analog input X6/X7	35
6.7.1	Analog inputs X6/X7.....	35
6.7.2	PIN assignment X6	35
6.7.3	PIN assignment X7	36
6.7.4	Circuitry overview X6/X7	36
6.7.5	Connecting signal source to X6/X7	36
6.8	Connection to temperature input X8.....	37

6.8.1	Temperature input X8	37
6.8.2	PIN assignment X8	37
6.8.3	Circuitry overview X8	37
6.8.4	Connecting temperature sensor to X8	38
6.9	Connection to the RS485 X9 input	38
6.9.1	RS485 input X9	38
6.9.2	PIN assignment X9	39
6.9.3	Circuitry overview X9	39
6.9.4	Connecting RS485 devices to X9.....	39
6.10	Connection to digital input X10	40
6.10.1	Digital inputs X10	40
6.10.2	PIN assignment X10.....	41
6.10.3	Circuitry overview X10.....	41
6.10.4	Connecting signal source to X10.....	42
6.11	Connection to digital input X11	42
6.11.1	Digital inputs X11	42
6.11.2	PIN assignment X11	43
6.11.3	Circuitry overview X11	43
6.11.4	Connecting signal source to X11.....	43
6.12	Connection to the multifunction relay X12/X13	44
6.12.1	Digital output X12/X13 (MFR).....	44
6.12.2	Pin assignment X12 (MFR).....	44
6.12.3	Pin assignment X13 (MFR).....	44
6.12.4	Circuitry overview X12/X13.....	45
6.12.5	Connecting signal source to X12/X13	45
6.13	Connection to the system network X14/X15	45
6.13.1	System network X14/X15.....	45
6.13.2	Connecting network cables to X14/X15.....	46
6.14	Connection to the Internet X16	46
6.14.1	Internet X16.....	46
6.14.2	Connecting network cable to X16.....	46
6.15	Connection to the voltage supply X1	47
6.15.1	Voltage supply X1	47
6.15.2	PIN assignment X1	47
6.15.3	Circuitry overview X1	47
6.15.4	Connecting the voltage supply to X1	48
7	Commissioning	50
7.1	Requirements for Commissioning	50
7.2	Changing the Network Configuration	50
7.3	Starting the Installation Assistant.....	50
7.4	Establishing a connection to the user interface	51
7.4.1	Connection in the local network.....	51
7.4.1.1	Access addresses for the product in the local network.....	51

7.4.1.2	Ports for data communication in the local network	51
7.4.1.3	Establishing a connection in the local network.....	52
7.4.2	Direct connection via Wi-Fi	52
7.4.2.1	Connection options for Wi-Fi direct connection	52
7.4.2.2	Access information for direct Wi-Fi connection	53
7.4.2.3	Establishing a direct Wi-Fi connection by entering the Wi-Fi data	53
7.4.2.4	Establishing a direct Wi-Fi connection by scanning the QR code.....	53
7.5	Registration in Sunny Portal.....	54
7.5.1	Profiles for data communication	54
7.5.2	Register as a new user in Sunny Portal.....	54
7.5.3	Log in to Sunny Portal as an existing user	55
7.5.4	Create new PV system	55
7.5.5	Add product to an existing system	56
8	Operation	57
8.1	Design of the User Interface	57
8.2	Access rights to the user interface	58
8.3	Device Administration	58
8.3.1	Register Devices	58
8.3.2	Delete devices	59
8.4	Backup file	59
8.4.1	Function and content of the backup file	59
8.4.2	Creating a Backup File	60
8.4.3	Upload backup file	60
8.5	Resetting the product to default setting	61
8.6	Deleting the Admin Account	61
8.7	Firmware Update	61
8.7.1	Carry out a manual firmware update.....	61
8.7.2	Automatically Updating the Firmware.....	62
8.7.3	Automatically updating the firmware of connected devices	63
8.8	Grid management service	63
8.8.1	Active Power Limitation.....	63
8.8.2	Configuring active and reactive power setpoints	64
8.8.3	Configure additional specifications from the grid operator for the country data set	64
8.8.4	Configure additional direct seller's specifications for the country data set.....	65
8.9	Modbus	66
8.9.1	SMA Modbus Profile	66
8.9.2	SunSpec Modbus Profile	66
8.9.3	Creating a New Modbus Profile	66

8.9.4	Registering a New Modbus Device and Assigning a Modbus Profile	67
8.10	Limiting-value based switching	67
8.10.1	Operators for limit-based switching	67
8.10.2	Parameter for limit-based switching	67
8.10.3	Switch digital outputs based on thresholds	68
8.11	Speedwire encryption	68
8.11.1	Speedwire Encryption of the System Communication	68
8.11.2	Enabling Speedwire Encryption	68
8.12	Fallback Behavior	69
8.12.1	Function of the fallback behavior	69
8.12.2	Fallback behavior in the event of communication failure to the digital inputs	69
8.12.3	Fallback behavior in the event of communication failure to the energy meter at the point of interconnection	69
8.12.4	Fallback behavior in reactive power mode	69
8.13	Replace the SMA Data Manager M (EDMM-10) with the SMA Data Manager M (EDMM-20)	70
9	Troubleshooting	72
9.1	Obsolete or incorrect measured values are displayed	72
9.2	Not all devices are being detected	72
9.3	The product user interface cannot be called up	72
9.4	Parameter changes via the device settings or a parameter adjustment are not confirmed	73
9.5	The product cannot be registered in Sunny Portal	73
9.6	The firmware of a connected SMA product was not updated during a firmware update	73
9.7	No data are displayed on the user interface of the product	74
10	Decommissioning the Product	75
11	Disposal	76
12	Technical Data	77
12.1	Communication	77
12.2	Voltage supply	77
12.3	Climatic Conditions	77
12.4	General Data	77
12.5	Digital inputs	78
12.6	Digital output (multifunction relay)	78
12.7	Analog inputs	78
12.8	Analog outputs	78
12.9	Temperature inputs	78

12.10	RS485 inputs	79
12.11	Equipment	79
13	Accessories	80
14	Compliance Information	81
15	EU Declaration of Conformity	82
16	Contact	83

1 Information on this Document

1.1 Validity

This document is valid for:

- EDMM-20 (SMA Data Manager M)

1.2 Target Group

The tasks described in this document must only be performed by qualified persons. Qualified persons must have the following skills:

- Training in the installation and commissioning of electrical devices and installations
- Training in the installation and configuration of IT systems
- Knowledge of all applicable laws, regulations, standards, and directives
- Knowledge of how an inverter works and is operated
- Knowledge of and compliance with this document and all safety information
- Training in how to deal with the dangers and risks associated with installing, repairing and using electrical devices and installations

1.3 Content and Structure of this Document

This document describes the mounting, installation, commissioning, configuration, operation, troubleshooting and decommissioning of the product.

The latest version of this document and additional information about the product can be found in PDF format and as an eManual at www.SMA-Solar.com. You can also call up the eManual via the user interface of the product.





Illustrations in this document are reduced to the essential information and may deviate from the real product.

1.4 Levels of Warning Messages

The following levels of warning messages may occur when handling the product.

 DANGER
Indicates a hazardous situation which, if not avoided, will result in death or serious injury.
 WARNING
Indicates a hazardous situation which, if not avoided, could result in death or serious injury.
 CAUTION
Indicates a hazardous situation which, if not avoided, could result in minor or moderate injury.
NOTICE
Indicates a situation which, if not avoided, can result in property damage.

1.5 Symbols in the Document

Symbol	Explanation
	Information that is important for a specific topic or goal, but is not safety-relevant
	Indicates a requirement for meeting a specific goal
	Required result
	Example
	Sections describing activities to be performed by qualified persons only

1.6 Typographies in the document

Typography	Use	Example
bold	<ul style="list-style-type: none"> Messages Terminals Elements on a user interface Elements to be selected Elements to be entered 	<ul style="list-style-type: none"> Connect the insulated conductors to the terminals X703:1 to X703:6. Enter 10 in the field Minutes.
>	<ul style="list-style-type: none"> Connects several elements to be selected 	<ul style="list-style-type: none"> Go to Settings > Date.
[Button] [Key]	<ul style="list-style-type: none"> Button or key to be selected or pressed 	<ul style="list-style-type: none"> Select [Enter].
#	<ul style="list-style-type: none"> Placeholder for variable components (e.g., parameter names) 	<ul style="list-style-type: none"> Parameter WCtHz.Hz#

1.7 Designations in the Document

Complete designation	Designation in this document
SMA Data Manager M	Data Manager, product
SMA Speedwire fieldbus	SMA Speedwire network, Speedwire
SMA Speedwire Encrypted Communication	Speedwire encryption
Sunny Portal powered by ennexOS	Sunny Portal

1.8 Additional Information

Additional information is available at www.SMA-Solar.com.

Title and information content	Type of information
Answers to frequently asked questions	FAQ on product page
User information on the operation and features of the product	User information on the user interface
"PUBLIC CYBER SECURITY - Guidelines for a Secure PV System Communication"	Technical Information
"Direct Marketing Interface"	Technical information
"SMA GRID GUARD 10.0 - Grid Management Services via Inverter and System Controller"	Technical Information
"Parameters and Measured Values" Device-specific overview of all parameters and measured values and their setting options Information about the SMA Modbus registers	Technical Information
"SMA Modbus ®-interface - ennexOS" Information on the SMA Modbus interface	Technical Information
"SunSpec Modbus ®-interface - ennexOS" Information about the SunSpec Modbus interface and supported information models	Technical Information
"SUNNY PORTAL powered by ennexOS"	User Manual
"RS485 Verkabelungsprinzip / Cabling Plan - SMA Data Manager M"	Technical Information
"System commissioning and setting the active and reactive power setpoints in systems with PV inverters of the type Sunny Tripower CORE2 and SMA Data Manager M"	Technical Information

2 Safety

2.1 Intended Use

The SMA Data Manager M is a data logger that acts as a System Manager and a system gateway. PV system components and PV systems are integrated into the SMA infrastructure via the SMA Data Manager M. This includes energy generators and loads, I/O systems, sensors and energy meters. The SMA Data Manager M is suited for systems with a maximum total PV or battery power of 2.5 MVA. In the process, the SMA Data Manager M is supporting communication with up to 50 devices such as PV inverters, battery inverters, energy meters and I/O systems.

The product is designed for indoor use only.

The product conforms with the EU grid connection conditions according to regulation (EU) 2016/631.

All components must remain within their permitted operating ranges and their installation requirements at all times.

The products by SMA Solar Technology AG are not suitable for use in

- Medical devices, in particular products for supplying life-support systems and machines,
- Aircraft, the operation of aircraft, the supply of critical airport infrastructure and airport systems,
- Rail vehicles, the operation and supply of rail vehicles and their critical infrastructure.

The above list is not exhaustive. Contact us if you are unsure whether products by SMA Solar Technology AG are suitable for your application.

Use SMA products only in accordance with the information provided in the enclosed documentation and with the locally applicable laws, regulations, standards and directives. Any other application may cause personal injury or property damage.

The documentation must be strictly followed. Deviations from the described actions and the use of materials, tools, and aids other than those specified by SMA Solar Technology AG are expressly forbidden.

Alterations to the SMA products, e.g., changes or modifications, are only permitted with the express written permission of SMA Solar Technology AG. Unauthorized alterations as well as failure to observe the documentation will void guarantee and warranty claims and in most cases terminate the operating license. SMA Solar Technology AG shall not be held liable for any damage caused by such changes.

Any use of the product other than that described in the Intended Use section does not qualify as appropriate.

The documentation supplied is an integral part of SMA products. Keep the documentation in a convenient, dry place for future reference and observe all instructions contained therein.

This document does not replace any regional, state, provincial, federal or national laws, regulations or standards that apply to the installation, electrical safety and use of the product. SMA Solar Technology AG assumes no responsibility for the compliance or non-compliance with such laws or codes in connection with the installation of the product.

The type label must remain permanently attached to the product.

2.2 IMPORTANT SAFETY INSTRUCTIONS

Keep the manual for future reference.

This section contains safety information that must be observed at all times when working.

The product has been designed and tested in accordance with international safety requirements. As with all electrical or electronic devices, some residual risks remain despite careful construction. To prevent personal injury and property damage and to ensure long-term operation of the product, read this section carefully and observe all safety information at all times.

WARNING

Danger to life due to electric shock

Under fault conditions, when working on the power supply circuit there may be dangerous voltages present on the product. This can result in death or serious injury.

- For power supply units with a fixed connection, make sure that a disconnection unit (e.g. miniature circuit breaker) is present outside the power supply unit.
- For power supply units with a plug connection, make sure that the electrical outlet for the power supply unit is close to the power supply unit.
- The disconnection unit and the electrical outlet for the power supply unit must be freely accessible at all times.

CAUTION

Damage due to electromagnetic radiation

This product emits electromagnetic radiation during operation, which may interfere with the operation of other devices and active body aids (e.g. pacemakers).

- Persons must not remain closer than 20 cm (8 in) to the product for long periods of time.

NOTICE

Damage to the product due to condensation

If the product is moved from a cold environment to a warm environment, condensation may form in the product. This can damage the product or impair its functionality.

- When there are large temperature differences, wait until the product has reached room temperature to connect the voltage supply.
- Make sure the product is dry.

NOTICE**Manipulation of system data in networks**

You can connect the supported SMA products to the Internet. When connected to the Internet, there is a risk that unauthorized users can access and manipulate the data of your system.

- Set up a firewall.
- Close unnecessary network ports.
- If absolutely necessary, only enable remote access via a virtual private network (VPN).
- Do not use the port forwarding feature. This also applies to the used Modbus ports.
- Disconnect system components from other network components (network segmentation).

i DHCP Server is recommended

The DHCP server automatically assigns the appropriate network settings to your nodes in the local network. A manual network configuration is therefore not necessary. In a local network, the Internet router is usually the DHCP server. If the IP addresses in the local network are to be assigned dynamically, DHCP must be activated in the Internet router (see the Internet router manual). In order to receive the same IP address by the internet router after a restart, set the MAC address binding.

In networks where no DHCP server is active, proper IP addresses must be assigned from the free address pool of the network segment to all network participants to be integrated during commissioning.

i IP addresses of Modbus devices

In systems with Modbus devices, static IP addresses must be assigned to all Modbus devices. Suitable IP addresses can be assigned to the Modbus devices from the free address supply of the network segment either manually or dynamically via DHCP.

If the IP addresses are to be assigned dynamically, DHCP must be activated in the Internet router (see the Internet router manual). Make sure that the Modbus devices do not contain variable IP addresses but always the same IP addresses (static DHCP).

This also applies to Data Managers that are used as subordinate devices.

If IP addresses of Modbus devices have been changed, all devices must be restarted.

i Communication disturbances in the local network

The IP address range 192.168.12.0 to 192.168.12.255 is occupied for communication amongst SMA products and for direct access to SMA products.

Communication problems might occur if this IP address range is used in the local network.

- Do not use the IP address range 192.168.12.0 to 192.168.12.255 in the local network.

3 Scope of delivery

Check the scope of delivery for completeness and any externally visible damage. Contact your distributor if the scope of delivery is incomplete or damaged.

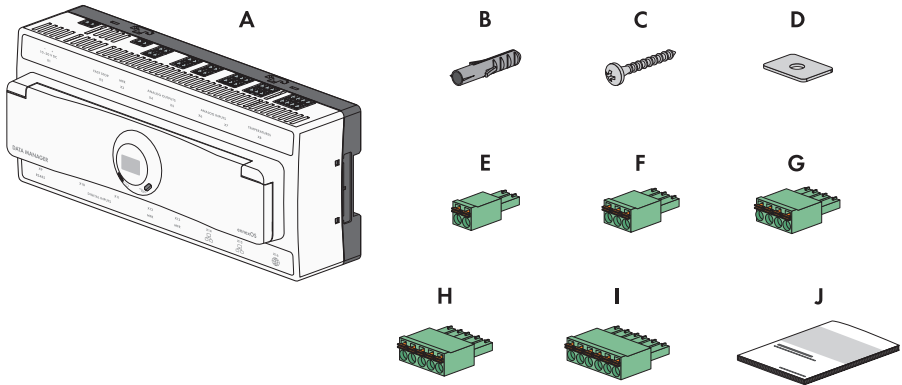

Figure 1: Components included in scope of delivery

Position	Quantity	Designation
A	1	SMA Data Manager M
B	4	Screw anchor
C	4	Bolt
D	4	Washer
E	8	Two-pole connector
F	7	Three-pole connector
G	4	Four-pole connector
H	2	Five-pole connector
I	2	Six-pole connector
J	1	Quick reference guide

4 Product overview

4.1 Device function

Several Data Managers can be integrated into one system. It is possible to choose between the following device functions:

- System Manager
- Superordinate System Manager
- Subordinate System Manager

In systems with a superordinate and subordinate System Managers, all subordinate System Managers must first be commissioned to be able to integrate them into the system of the superordinate System Manager. To subsequently use a System Manager or a superordinate System Manager as a subordinate System Manager, the product must be reset to the default settings.

System Manager

Select the option **System Manager** in the installation assistant if you use the Data Manager as a stand-alone device without other subordinate Data Managers for open-loop or closed-loop control of your system.

Superordinate System Manager

Select the option **Superordinate system manager** in the installation assistant if you use the Data Manager as a superordinate device with other subordinate Data Managers for open-loop or closed-loop control of your system. With this option, the superordinate Data Manager forwards the open-loop or closed-loop control commands to the subordinate Data Manager via Modbus. For this, subordinate Data Managers must be integrated as Modbus devices into the system of the superordinate Data Manager. Meters at the grid-connection point must be connected to the superordinate Data Manager. The Modbus server must be activated in the superordinate Data Manager.

Subordinate System Manager

Select the option **Subordinate system manager** in the installation assistant if you want to use the Data Manager as subordinate device. With this option, the subordinate Data Manager receives the open-loop and closed-loop control commands of a superordinate device. These commands are forwarded as open-loop control commands to the connected devices. In systems with a superordinate Data Manager, all subordinate System Managers must first be commissioned to be able to integrate them into the system of the superordinate Data Manager. The operating mode **Control** and the signal source **Modbus** must be selected for the subordinate Data Manager. The option **Optimized closed-loop control/open-loop control** must be disabled. The Modbus server must be activated in the subordinate Data Manager. Under the **Direct seller settings**, the **Source for external setpoint** must be activated and **Modbus** must be selected.

Also see:

- [Registration in Sunny Portal](#) ⇒ page 54

4.2 Product Description

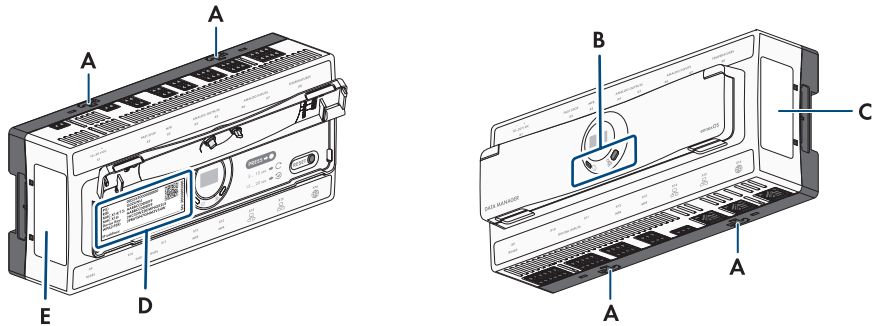















Figure 2: Design of the product

Position	Designation
A	Press-out base latches for wall mounting
B	LEDs The LEDs indicate the operating state of the product.
C	Type label The type label clearly identifies the product. The type label must remain permanently attached to the product. You will find the following information on the type label: <ul style="list-style-type: none"> • Device type (Model) • Serial number (Serial No. or S/N) • Date of manufacture • Device-specific characteristics
D	Device label with device information and QR code for scanning
E	Device label with certification mark

4.3 Symbols on the Product

Symbol	Explanation
	Internet
	System LED
	COM LED

Symbol	Explanation
	Ethernet
	WEEE designation Do not dispose of the product together with the household waste but in accordance with the disposal regulations for electronic waste applicable at the installation site.
	The product is suitable for indoor installation.
	CE marking The product complies with the requirements of the applicable EU directives.
	FCC designation The product complies with the requirements of the applicable FCC standards.
	RCM (Regulatory Compliance Mark) The product complies with the requirements of the applicable Australian standards.
	This equipment contains specified radio equipment that has been certified to the Technical Regulation Conformity Certification under the Radio Law.
	ICASA The product complies with the requirements of the South African standards for telecommunication.
	ANATEL The product complies with the requirements of the Brazilian standards for telecommunication. Este equipamento opera em caráter secundário, isto é, não tem direito a proteção contra interferência prejudicial, mesmo de estações do mesmo tipo, e não pode causar interferência a sistemas operando em caráter primário.
	The product complies with the Moroccan safety and EMC requirements for electronic products.

4.4 Reset button

Depending on how long it is activated for, the reset button performs the following functions:



- 1 to 5 seconds: no effect
- 5 to 10 seconds: restarts the product
- 10 to 15 seconds: resets password and administrator account of the product



- 15 to 20 seconds: resets the product to the default settings
- Longer than 20 seconds: no effect

The length of time the reset button has been activated for is indicated via LED signals (see Section 4.5, page 20).

4.5 LED Signals

The LEDs indicate the operating state and communication status of the product. Not relevant operating states are shown as "-".

System LED	COM LED	Explanation
		
Startup process		
Off	Off	No power supply or no boot up procedure.
Glowing orange	Glowing orange	Boot up procedure started.
Flashing green	-	User interface is being loaded.
Glowing green	Glowing orange	Communication is being started.
Glowing red	Off	Boot up procedure running.
Glowing red (for longer than 2 minutes)	Off	Errors during the booting procedure.
Glowing green	-	Normal operation
Flashing red	-	System error
Flashing orange	-	Update procedure running.
Communication status		
-	Flashing orange and green in alternation	WLAN access point is activated.
-	Flashing green	Connection to all devices connected via LAN is established.
-	Glowing orange	Connection to at least 1 device connected via LAN is disrupted.
-	Glowing red	Connection to all devices connected via LAN is disrupted.
Function button		
Flashing orange and green in alternation	Off	Function button has been pressed for less than 5 seconds.

System LED	COM LED	Explanation
		
Flashing orange and green in alternation	Glowing green	Function button has been pressed for between 5 and 10 seconds.
Flashing orange and green in alternation	Glowing orange	Function button has been pressed for between 10 and 15 seconds.
Flashing orange and green in alternation	Glowing red	Function button has been pressed for between 15 and 20 seconds.
Glowing green	-	Function button has been pressed for longer than 20 seconds.

4.6 Interfaces and Functions

4.6.1 Wi-Fi access point

The product is equipped with a Wi-Fi interface as standard. By tapping twice on the product, a Wi-Fi access point is activated. This point is used to connect the product to a smart terminal (e.g. smartphone, tablet or laptop). This allows to carry out commissioning and configuration via direct Wi-Fi connection on site regardless of the wired network.

4.6.2 SMA Speedwire

The product is equipped with SMA Speedwire as standard. SMA Speedwire is a type of communication based on the Ethernet standard. SMA Speedwire is designed for a data transfer rate of 100 Mbps and enables optimum communication between Speedwire devices within systems.

The products supports the encrypted system communication with SMA Speedwire Encrypted Communication. In order to be able to use the Speedwire encryption in the system, all Speedwire devices, except for the energy meter (e.g. SMA Energy Meter) must support the function SMA Speedwire Encrypted Communication.

4.6.3 Modbus

The product is equipped with two Modbus interfaces. One interface can be controlled via Ethernet (Modbus TCP) and the other interface via RS485 (Modbus RTU).

The Modbus interfaces have the following tasks:

- Remote query of measured values
- Setpoint specifications for system control

The Modbus interfaces differ in their function as:

- Modbus server and

- Modbus client.

The function of the Modbus server is available via the Ethernet interface (Modbus TCP). The Modbus server can be used for external access to the product (e.g. via SCADA systems).

The function of the Modbus client is available via the Ethernet interface (Modbus TCP) and the RS485 interface (Modbus RTU). The Modbus client can be used for communication with connected Modbus devices (e.g., inverters, energy meters, I/O systems).

For the communication with connected Modbus devices, predefined Modbus profiles and user-created Modbus profiles can be used. User-created Modbus profiles can be exported and transferred to another product.

4.6.4 SunSpec Modbus

The product supports the standardized SunSpec Modbus profile via the interface of the Modbus client (Modbus TCP/RTU). The SunSpec Modbus profile from the SunSpec Alliance contains a comprehensive set of measured values and parameters for Modbus devices in decentralized power generation systems (e.g. inverters, energy meters, weather stations). The product has data points of the SunSpec Alliance and therefore conforms with the SunSpec Modbus profile of the underlying specification version (see www.sunspec.org). Connected Modbus devices compatible with the SunSpec Modbus profile are automatically integrated into the system with the appropriate Modbus profile.

4.6.5 User Interface

The product is equipped as standard with an integrated webserver, which provides a user interface for configuring and monitoring the product.

Once the connection has been established to the smart device, use a terminal (e.g. smartphone, tablet or laptop) to connect to the product's user interface using a web browser.

Connected SMA products can be configured and commissioned via the user interface of the product.

Also see:

- [Access rights to the user interface ⇒ page 58](#)
- [Design of the User Interface ⇒ page 57](#)

4.6.6 Sunny Portal

Sunny Portal is an Internet portal which enables you to monitor systems and to visualize system data.

The Sunny Portal serves as the user interface for the extended configuration of the product, of system sections, systems, system groups and the entire system portfolio. The Sunny Portal monitors and analyzes the system and its components on all levels.

There are two Sunny Portal versions: the Sunny Portal Classic ([https:// www.sunnyportal.com](https://www.sunnyportal.com)) and the newly developed Sunny Portal powered by ennexOS ([https:// ennexOS.sunnyportal.com](https://ennexOS.sunnyportal.com)).

Both systems differ in their supported functions. With an existing user account, you can log into both portals, the Sunny Design (system planning software from SMA) as well as the app SMA 360°.

4.6.7 Dashboard

On the dashboard of the user interface, information on the product, the plant and its components is displayed clearly and at a glance using widgets. The dashboard display can vary depending on the system's functional scope and user rights.

Information, such as yield forecast, system section visualization and inverter comparison, are available via the extended functions in Sunny Portal.

4.6.8 Plant-wide parameterization

You can use the system parameter assistant to change the parameters of connected devices at the same time and to compare them. Simply select the desired devices from a list and change the parameters that are suitable for simultaneous change. The status of the parameter changes is accessible at all times.

4.6.9 Energy Monitoring

Several SMA Energy Meters and Modbus energy meters from other manufacturers can be connected for comprehensive energy monitoring. The product can also read out, save and display the generation and consumption data of the meters.

In addition, energy meters (e.g. a gas meter) can be registered via the extended functions in Sunny Portal. The meter readings can be entered manually and displayed.

4.6.10 FTP push

The FTP Push function can be used to upload collected system data to a freely selectable external FTP server. The collected system data is uploaded to the specified directory hourly or once a day. Here, the system data is exported in an unchangeable XML format. The system data and user data is transmitted via standard FTP protocol to the FTP server without encryption.

4.6.11 SMA Smart Connected

SMA Smart Connected is the free monitoring of the connected SMA inverters via the SMA Sunny Portal. Thanks to SMA Smart Connected, the operator and qualified person will be informed automatically and proactively about events that occur in the connected SMA inverters.

SMA Smart Connected is activated during registration in Sunny Portal. In order to use SMA Smart Connected for connected inverters, it is necessary that the product is permanently connected to Sunny Portal and the data of the operator and qualified person is stored in Sunny Portal and up to date.

SMA Smart Connected can only be used in Sunny Portal when this feature is supported by the SMA inverters.

4.6.12 Grid Management Services

The product is equipped with service functions for grid management.

Depending on the requirements of the grid operator, you can activate and configure the functions (e.g. active power limitation) via operating parameters.

The setpoints from the grid operator can either be implemented via open-loop control or closed-loop control. The setpoints are specified via Modbus, analog or digital signals or manually via the user interface. The implementation of the setpoints is reported back to the grid operator.

4.6.13 Reactive Power Control

The reactive power control can take place through direct parameter settings (Q , $\cos \varphi$) in the installation assistant, as a variable specification from the grid operator via the Modbus interface or via analog signals. The reactive power control as characteristic curve function can also be regulated as a function of the voltage at the point of interconnection $Q(V)$. The values are specified as a percentage of the maximum AC power. A proper meter for measuring the relevant electrical variables (V , P , Q) is required at the grid-connection point. A pure voltage measurement is not sufficient. A suitable energy meter is also required at the point of interconnection for $\cos \varphi$ specifications in control mode.

4.6.14 Zero export

Some grid operators permit connection of PV systems only on condition that no active power is fed into the utility grid. The PV energy is therefore consumed exclusively at the place where it is generated.

When specifications at the point of interconnection are actively controlled, this product enables the limitation the active power feed-in for the connected SMA inverters and of third-party inverters to 0% as long as these are connected via SunSpec Modbus and support this function.

4.6.15 Active Power Limitation

The setpoint for active power limitation is specified in percent. The total system power is taken as the reference value. The setpoints are specified via Modbus, analog or digital signals or manually via the user interface.

4.6.16 Direct selling

A direct marketer can use the product for remotely controlling the system via the built-in direct marketing interface. In this process, control signals of the direct marketer are transferred to the system. The function is activated via the user interface of the product.

4.6.17 Device Key (DEV KEY)

If you have forgotten the administrator password for the product, you can reset the administrator account with the device key and assign a new password. The device key can be used to prove the identity of the product in digital communication. The device key is located on the type label of the product.

5 Mounting

5.1 Requirements for Mounting

5.1.1 Requirements for the Mounting Location

⚠ WARNING

Danger to life due to fire or explosion

Despite careful construction, electrical devices can cause fires. This can result in death or serious injury.

- Do not mount the product in areas containing highly flammable materials or gases.
- Do not mount the product in potentially explosive atmospheres.

⚠ CAUTION

Damage due to electromagnetic radiation

This product emits electromagnetic radiation during operation, which may interfere with the operation of other devices and active body aids (e.g. pacemakers).

- Persons must not remain closer than 20 cm (8 in) to the product for long periods of time.

- A solid, flat support surface must be available for mounting.
- The DIN rail must be firmly attached to the wall when mounting to the DIN rail.
- The mounting location must be inaccessible to children.
- The mounting location must be suitable for the weight and dimensions of the product.
- The installation site should be freely and safely accessible at all times without the need for any auxiliary equipment (such as scaffolding or lifting platforms). Non-fulfillment of these criteria may restrict servicing.
- All ambient conditions must be met.
- The labelling on the product must be readable after installation.

5.1.2 Permitted and prohibited mounting positions

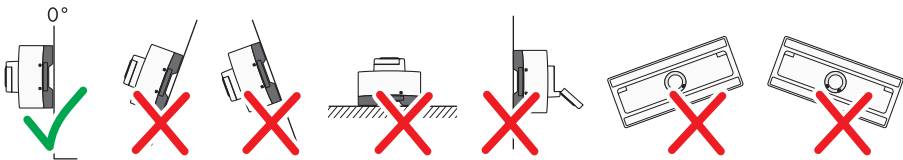

Figure 3: Mounting position

- The product may only be mounted in a horizontal position.

5.1.3 Dimensions for mounting

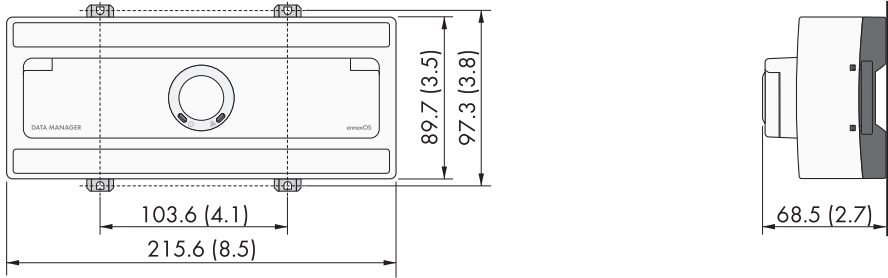

Figure 4: Dimensions for wall mounting (dimensions in mm (in))

5.1.4 Recommended clearances for mounting

- A clearance of 50 mm (2 in) must be observed above and below to other objects.

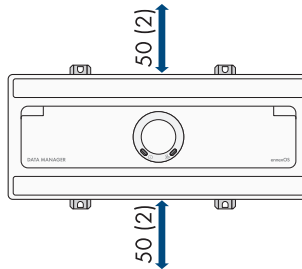

Figure 5: Recommended clearances

5.2 Mounting the Product on the DIN Rail

Additionally required mounting material (not included in the scope of delivery):

- Top-hat rail (TH 35-7.5)

Procedure:

1. Place the product onto the DIN rail from above and hook it into place.

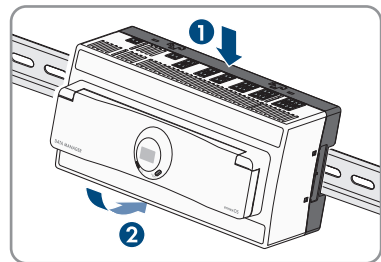

- The product snaps audibly into place.
2. Ensure that the product is securely in place.

5.3 Mounting the Product on the Wall

1. Press the four base latches on the back side of the product out from the inside.

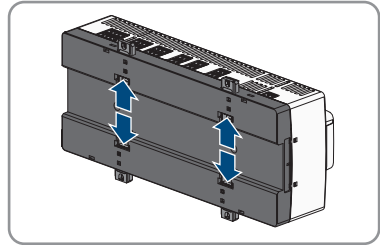

- ☑ The base latches snap audibly into place.
2. Mark the drill holes using the base latches as a template.
 3. Drill the holes and insert the provided screw anchors. Do not drill through the base latches.
 4. Insert the provided screws through the base latches and the supplied washers and tighten. Make sure not to damage the base latches.

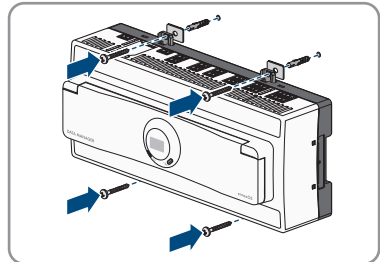

5. Ensure that the product is securely in place.

6 Connection

6.1 Requirements for the Connection

6.1.1 Connection cable requirements for power supply terminal X1

- Conductor cross-section: 0.22 mm² (24 AWG) to 1.5 mm² (16 AWG)
- The cable must have at least two insulated conductors
- Maximum cable length: < 3 m (9.8 ft)
- Cable with shielding: No

6.1.2 Signal cable requirements for fast stop X2

- Conductor cross-section: 0.5 mm² (21 AWG) to 1.5 mm² (16 AWG)
- Maximum cable length: < 30 m (98 ft)
- Cable with shielding: No

6.1.3 Signal cable requirements for multifunction relay X3

- Conductor cross-section: 0.22 mm² (24 AWG) to 1.5 mm² (16 AWG)
- Maximum cable length: < 30 m (98 ft)
- Cable with shielding: No

6.1.4 Signal cable requirements for analog terminals X4 to X7

- Conductor cross-section: 0.22 mm² (24 AWG) to 1.5 mm² (16 AWG)
- Maximum cable length: < 30 m (98 ft)
- Twisted pair conductors
- Cable with shielding: Yes (on one side on external shield connection terminal)

6.1.5 Signal cable requirements for temperature input X8

- Conductor cross-section: 0.5 mm² (21 AWG) to 1.5 mm² (16 AWG)
- Maximum cable length with 4-conductor measurement: < 30 m (98 ft)
- Maximum cable length with 2-conductor measurement: < 2.5 m (8 ft)
- Twisted pair conductors
- Cable with shielding: Yes (on one side on external shield connection terminal)

6.1.6 RS485 X9 cable requirements

- Number of insulated conductor pairs and insulated conductor cross-section: at least 2 x 2 x 0.22 mm² (2 x 2 x 24 AWG)
- Maximum cable length across the entire RS485 bus: < 1200 m (3937 ft)
- Twisted pair conductors
- Cable with shielding: Yes (on both sides on external shield connection terminal)

6.1.7 Signal cable requirements for digital terminals X10 to X13

- Conductor cross-section: 0.22 mm² (24 AWG) to 1.5 mm² (16 AWG)
- Maximum cable length: < 30 m (98 ft)
- Cable with shielding: No

6.1.8 Network cable requirements X14 to X16

The cable length and quality affect the quality of the signal. Observe the following cable requirements:

- Cable type: 100BaseTx
- Cable category: minimum CAT5e
- Plug type: RJ45 of Cat5, Cat5e, Cat6 or Cat6a (Cat7 plugs cannot be used)
- Shielding: S/UTP, F/UTP or higher
- Number of insulated conductor pairs and insulated conductor cross-section: at least 2 x 2 x 0.22 mm² (2 x 2 x 24 AWG)
- Maximum cable length between two nodes when using patch cables: < 50 m (164 ft)
- Maximum cable length between two nodes when using installation cables: < 100 m (328 ft)
- UV-resistant for outdoor use

6.2 Overview of the Connection Area

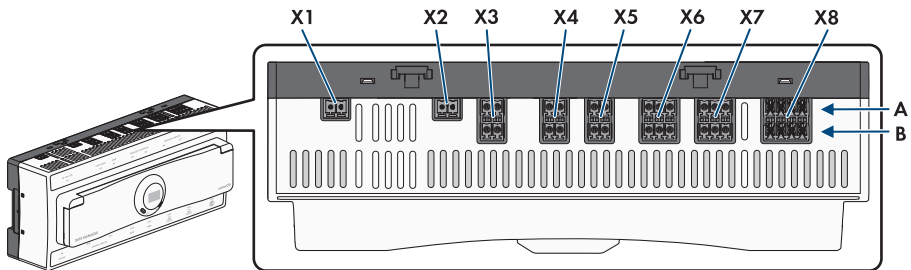

Figure 6: Overview of the upper connection area

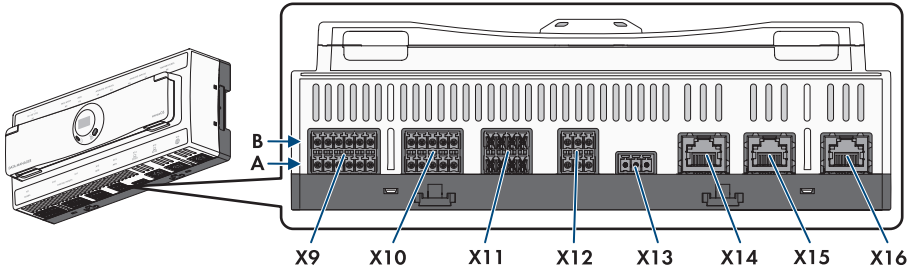

Figure 7: Overview of the lower connection area

Connection	Explanation
X1	Jack for connecting the voltage supply
X2	Socket for connecting a switch for the fast stop
X3	Socket for the connection to the multifunction relay
X4	Socket for the connection to analog output signals
X5	Socket for the connection to analog output signals
X6	Socket for connecting analog input signals
X7	Socket for connecting analog input signals
X8	Socket for connecting the temperature sensors
X9	Jack for connecting the RS485 devices
X10	Socket for connecting potential-free switching contacts
X11	Socket for connecting potential-free switching contacts
X12	Socket for the connection to the multifunction relay
X13	Socket for the connection to the multifunction relay
X14	Network port for connecting to the SMA Speedwire network
X15	Network port for connecting to the SMA Speedwire network
X16	Network port for connecting to the Internet

6.3 Preparing the Connection Cable

Always proceed as follows to prepare each connection cable for connection to multipole plugs.

Procedure:

1. Strip 40 mm (1.57 in) of cable sheath from the end of the connection cable to which the multipole plug is to be attached. When doing so, ensure that no pieces of cable fall into the enclosure.

2. Strip off 10 mm (0.39 in) of the conductor insulation from each of the required connection cable conductors.
3. Trim unneeded insulated conductors of the connection cable flush with the cable sheath.
4. If needed, push 1 bootlace ferrule onto 1 stripped insulated conductor as far as it will go and crimp using a crimping tool.

6.4 Terminal for fast stop X2

6.4.1 Fast stop X2

You can connect one fast-stop switch at digital input **X2**. The switch at the digital input **X2** can be configured on the user interface as make contact or break contact. By default, the digital input **X2** is configured as a make contact.

With the fast stop function, depending on the set inverter operating mode, inverters can be disconnected from the utility grid or enter into standby operation. For further information on SMA products with fast-stop function, see manual of the SMA products.

6.4.2 PIN assignment X2

Fast stop X2	Row (User interface)	Pin	Assignment
	A	1	Voltage supply output
	(Fast Stop)	2	Fast-stop input

6.4.3 Circuitry overview X2

SMA Data Manager



Figure 8: Connection example of a fast-stop switch for one device

6.4.4 Connect switch for fast stop to X2

⚠ QUALIFIED PERSON

Requirements:

- The signal source must be technically suitable for connection to the digital inputs (see Section 12, page 77).

- The connected digital signal source has a safe separation to the grid potential. When connecting the digital signal source the potential-free contact or an external potential-free contact is used.
- The connection cable is prepared for connection to the multipole connector (see Section 6.3, page 30).

Procedure:

1. Connect the connection cable to the switch for the fast stop (see the manual from manufacturer).
2. Connect the connection cable to the supplied two-pole plug. Ensure that the conductors are plugged completely into the terminal points up to their insulation.
3. Plug the 2-pole connector into the socket **X2** on the product. Observe the pin assignment.
4. Ensure that the connector is securely in place.
5. Ensure that all conductors are correctly connected.
6. Ensure that the conductors sit securely in the terminal points.

6.5 Connection to the multifunction relay X3

6.5.1 Digital output X3 (MFR)

The multifunction relay (MFR) is a digital output that can be specifically configured to the system. The digital output **X3** consists of two make contacts via which consuming devices can be controlled. SG-ready devices can be used (e.g. heat pumps).

6.5.2 Pin assignment X3 (MFR)

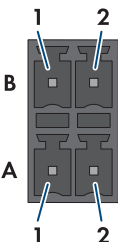
Digital output X3	Row (User interface)	Pin	Assignment
	B	1	Make contact (open when idle)
		2	COM (common contact)
	A	1	Make contact (open when idle)
		2	COM (common contact)

6.5.3 Circuitry overview X3

SMA Data Manager



Figure 9: Connection example of consuming device to make contact

6.5.4 Connecting signal source to X3

⚠ QUALIFIED PERSON

Requirements:

- The technical requirements of the multifunction relay must be met (see Section 12, page 77).

Procedure:

1. Connect the connection cable to the digital signal source (see the manual from manufacturer).
2. Connect the connection cable to the supplied two-pole plug. Ensure that the conductors are plugged completely into the terminal points up to their insulation.
3. Plug the 2-pole connector into the socket **X3** on the product. Observe the pin assignment.
4. Ensure that the connector is securely in place.
5. Ensure that all conductors are correctly connected.
6. Ensure that the conductors sit securely in the terminal points.

6.6 Connection to the analog output X4/X5

6.6.1 Analog outputs X4/X5

You can connect analog remote terminals to the four outputs **X4** and **X5**. Using this analog output, you can give the grid operator feedback, for example, if and which specifications for the grid management services are currently implemented in the system.

6.6.2 PIN assignment X4

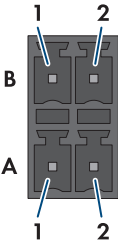
Analog output X4	Row (User interface)	Pin	Assignment
	B (Analog output 2)	1	Current output (0 to 20 mA)
		2	Ground (GND)
	A (Analog output 1)	1	Current output (0 to 20 mA)
		2	Ground (GND)

6.6.3 PIN assignment X5

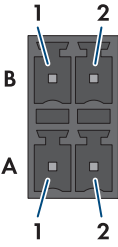
Analog output X5	Row (User interface)	Pin	Assignment
	B (Analog output 4)	1	Current output (0 to 20 mA)
		2	Ground (GND)
	A (Analog output 3)	1	Current output (0 to 20 mA)
		2	Ground (GND)

6.6.4 Circuitry overview X4/X5

SMA Data Manager



Figure 10: Connection of an analog remote terminal

6.6.5 Connecting the remote terminal to X4/X5

⚠ QUALIFIED PERSON

Requirements:

- The remote terminal must be technically suitable for connection to the analog outputs (see Section 12, page 77).

- The connection cable is prepared for connection to the multipole connector (see Section 6.3, page 30).

Procedure:

1. Connect the connection cable to the analog remote terminal (see the manual from manufacturer).
2. Remove the sheath from the connection cable.
3. Fold the surplus cable shield back over the cable sheath.
4. Strip the insulation off the wires.
5. Connect the connection cable to the supplied 2-pole connector. Ensure that the conductors are plugged completely into the terminal points up to their insulation.
6. Plug the 2-pole connector into the socket **X4/X5** on the product. Observe the pin assignment.
7. Ensure that the connector is securely in place.
8. Ensure that all conductors are correctly connected.
9. Ensure that the conductors sit securely in the terminal points.
10. Fit the cable shield onto an external shielding clamp.

6.7 Connection to the analog input X6/X7

6.7.1 Analog inputs X6/X7

You can connect analog signal sources to the four analog inputs **X6** and **X7**. A remote terminal unit can be used as an analog signal source, for example.

6.7.2 PIN assignment X6

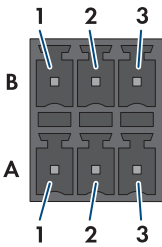
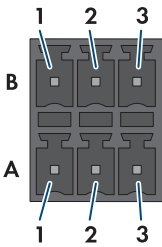
Analog input X6	Row (User interface)	Pin	Assignment
	B (Analog input 2)	1	Current input
		2	Ground (GND)
		3	Do not use
	A (Analog input 1)	1	Current input
		2	Ground (GND)
		3	Do not use

6.7.3 PIN assignment X7

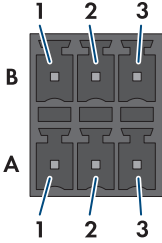
Analog input X7	Row (User interface)	Pin	Assignment
	B (Analog input 4)	1	Current input
		2	Ground (GND)
		3	Do not use
	A (Analog input 3)	1	Current input
		2	Ground (GND)
		3	Do not use

6.7.4 Circuitry overview X6/X7

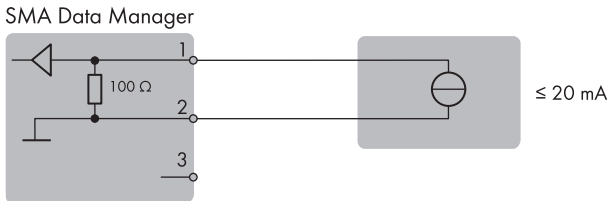

Figure 11: Connection of an analog signal source

6.7.5 Connecting signal source to X6/X7

⚠ QUALIFIED PERSON

Requirements:

- The signal source must be technically suitable for connection to the analog inputs (see Section 12, page 77).
- The connection cable is prepared for connection to the multipole connector (see Section 6.3, page 30).

Procedure:

1. Connect the connection cable to the analog remote terminal (see the manual from manufacturer).
2. Remove the sheath from the connection cable.
3. Fold the surplus cable shield back over the cable sheath.
4. Strip the insulation off the wires.
5. Connect the connection cable to the supplied 3-pole connector. Ensure that the conductors are plugged completely into the terminal points up to their insulation.
6. Plug the 3-pole connector into the socket **X6/X7** on the product. Observe the pin assignment.

7. Ensure that the connector is securely in place.
8. Ensure that all conductors are correctly connected.
9. Ensure that the conductors sit securely in the terminal points.
10. Fit the cable shield onto an external shielding clamp.

6.8 Connection to temperature input X8

6.8.1 Temperature input X8

You can connect PT100 temperature sensors to the two analog temperature inputs **X8**. One outside temperature sensor and one module temperature sensor, for example, can be used as temperature sensor. The analog temperature inputs can be used for 2-conductor and 4-conductor measurement.

6.8.2 PIN assignment X8

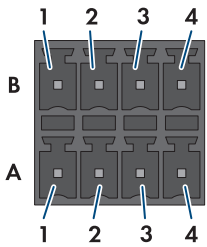
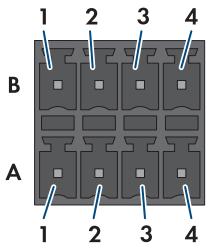
Temperature input X8	Row (User interface)	Pin	Assignment
	B (Temperature input 2)	1	Current output (I+)
		2	Voltage input (V+)
		3	Voltage return (V-)
		4	Current return (I-)
	A (Temperature input 1)	1	Current output (I+)
		2	Voltage input (V+)
		3	Voltage return (V-)
		4	Current return (I-)

6.8.3 Circuitry overview X8

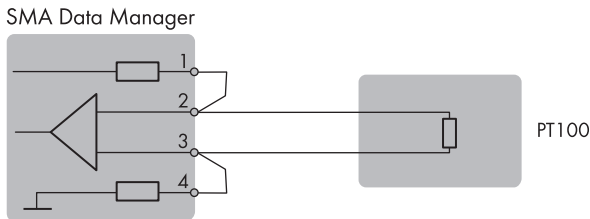

Figure 12: Connection of a temperature sensor with 2-conductor measurement

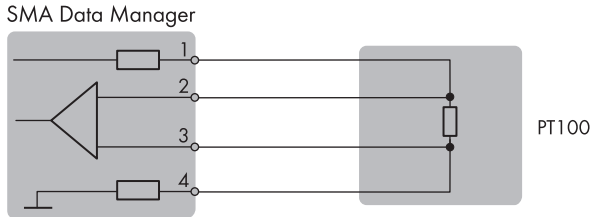

Figure 13: Connection of a temperature sensor with 4-conductor measurement

6.8.4 Connecting temperature sensor to X8

⚠ QUALIFIED PERSON

Requirements:

- The temperature sensor must be technically suitable for connection to the analog temperature inputs (see Section 12, page 77).
- The connection cable is prepared for connection to the multipole connector (see Section 6.3, page 30).

Procedure:

1. Connect the connection cable to the temperature sensor (see the manual from manufacturer).
2. Remove the sheath from the connection cable.
3. Fold the surplus cable shield back over the cable sheath.
4. Strip the insulation off the wires.
5. Connect the connection cable to the supplied 4-pole connector. Ensure that the conductors are plugged completely into the terminal points up to their insulation.
6. Plug the 4-pole connector into the socket **X8** on the product. Observe the pin assignment.
7. Ensure that the connector is securely in place.
8. Ensure that all conductors are correctly connected.
9. Ensure that the conductors sit securely in the terminal points.
10. Fit the cable shield onto an external shielding clamp.

6.9 Connection to the RS485 X9 input

6.9.1 RS485 input X9

You can connect RS485 devices for the communication with Modbus RTU to the two RS485 inputs **X9**. The bits in the product are set as follows and may need to be adjusted in the RS485 devices:

Set-up:	8 data bits
	1 stop bit
	no parity

6.9.2 PIN assignment X9

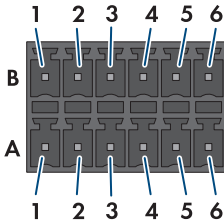
RS485 input X9	Row (User interface)	Pin	Assignment
	B (COM2RS485)	1	Data+ (D+)
		2	Do not use
		3	Ground (GND)
		4	Data- (D-)
		5	Line termination (optional)
		6	Line termination (optional)
	A (COM1RS485)	1	Data+ (D+)
		2	Do not use
		3	Ground (GND)
		4	Data- (D-)
		5	Line termination (optional)
		6	Line termination (optional)

6.9.3 Circuitry overview X9

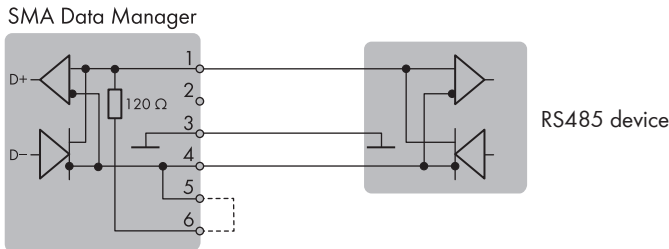

Figure 14: Connection of an RS485 device

6.9.4 Connecting RS485 devices to X9

⚠ QUALIFIED PERSON

Requirements:

- The same baud rate (1200 baud, 9600 baud or 19200 baud) must be set in all RS485 devices.
- The connection cable is prepared for connection to the multipole connector (see Section 6.3, page 30).

Procedure:

1. Connect the connection cable to the RS485 device (see the manual from manufacturer).
2. Remove the sheath from the connection cable.
3. Fold the surplus cable shield back over the cable sheath.
4. Strip the insulation off the wires.
5. Connect the connection cable to the supplied 6-pole connector. Ensure that the conductors are plugged completely into the terminal points up to their insulation.

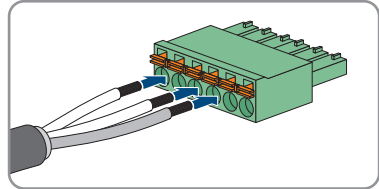

6. If the product is at the beginning or end of the RS485 bus, install a jumper wire as a line terminator between pin 5 and pin 6 on the six-pole connector.

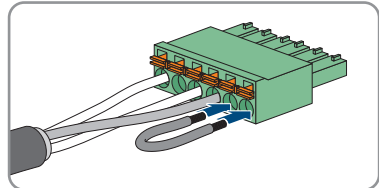

7. Plug the 6-pole connector into the socket **X9** on the product. Observe the pin assignment.
8. Ensure that the connector is securely in place.
9. Ensure that all conductors are correctly connected.
10. Ensure that the conductors sit securely in the terminal points.
11. Fit the cable shield onto an external shielding clamp.

Also see:

- [Technical Data](#) ⇒ page 77

6.10 Connection to digital input X10

6.10.1 Digital inputs X10

External signal sources with potential-free switching contacts can be connected to the six digital inputs **X10** (e.g., for active power limitation). You can use ripple control receivers or remote terminal units, for example, as external signal sources.

In a system with multiple SMA Data Managers, the external signal sources must be connected to the digital inputs of the System Manager.

6.10.2 PIN assignment X10

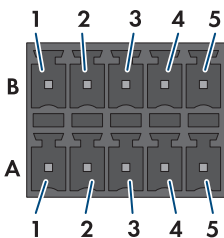
Digital input X10	Row	Pin	Assignment
	B	1	Digital input 5
		2	Voltage supply output
		3	Digital input 6
		4	Voltage supply output
		5	Do not use
	A	1	Digital input 1
		2	Digital input 2
		3	Digital input 3
		4	Digital input 4
		5	Voltage supply output

6.10.3 Circuitry overview X10

SMA Data Manager

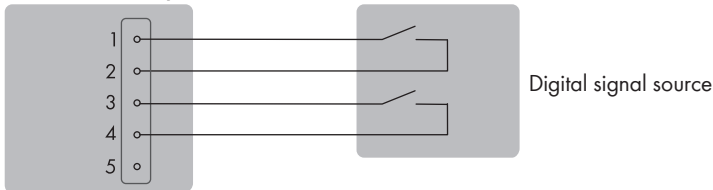

Figure 15: Connection example of a digital signal source to terminal X10/row B

SMA Data Manager

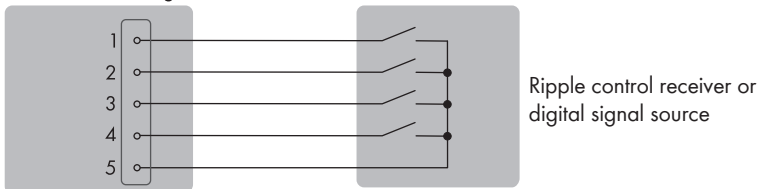

Figure 16: Connection example of a ripple control receiver or a digital signal source to terminal X10/row A

6.10.4 Connecting signal source to X10

QUALIFIED PERSON

Requirements:

- The signal source must be technically suitable for connection to the digital inputs (see Section 12, page 77).
- The connected digital signal source has a safe separation to the grid potential. When connecting the digital signal source the potential-free contact or an external potential-free contact is used.
- The connection cable is prepared for connection to the multipole connector (see Section 6.3, page 30).

Procedure:

1. Connect the connection cable to the digital signal source (see the manual from manufacturer).
2. Connect the connection cable to the supplied 5-pole connector. Ensure that the conductors are plugged completely into the terminal points up to their insulation.
3. Plug the 5-pole connector into the socket **X10** on the product. Observe the pin assignment.
4. Ensure that the connector is securely in place.
5. Ensure that all conductors are correctly connected.
6. Ensure that the conductors sit securely in the terminal points.

6.11 Connection to digital input X11

6.11.1 Digital inputs X11

External signal sources with potential-free switching contacts can be connected to the four digital inputs **X11** (e.g., for active power limitation). You can use ripple control receivers or remote terminal units, for example, as external signal sources.

In a system with multiple SMA Data Managers, the external signal sources must be connected to the digital inputs of the System Manager.

6.11.2 PIN assignment X11

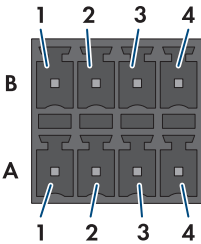
Digital input X11	Row	Pin	Assignment
	B	1	Digital input 9
		2	Voltage supply output
		3	Digital input 10
		4	Voltage supply output
	A	1	Digital input 7
		2	Voltage supply output
		3	Digital input 8
		4	Voltage supply output

6.11.3 Circuitry overview X11

SMA Data Manager

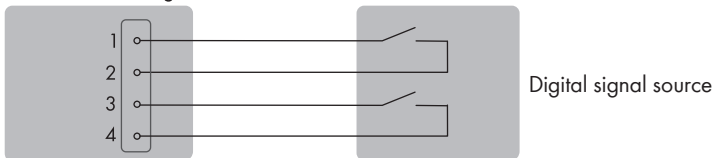

Figure 17: Connection example of a digital signal source / row A and B

6.11.4 Connecting signal source to X11

⚠ QUALIFIED PERSON

Requirements:

- The signal source must be technically suitable for connection to the digital inputs (see Section 12, page 77).
- The connected digital signal source has a safe separation to the grid potential. When connecting the digital signal source the potential-free contact or an external potential-free contact is used.
- The connection cable is prepared for connection to the multipole connector (see Section 6.3, page 30).

Procedure:

1. Connect the connection cable to the digital signal source (see the manual from manufacturer).
2. Connect the connection cable to the supplied 4-pole connector. Ensure that the conductors are plugged completely into the terminal points up to their insulation.
3. Plug the 4-pole connector into the socket **X11** on the product. Observe the pin assignment.
4. Ensure that the connector is securely in place.

5. Ensure that all conductors are correctly connected.
6. Ensure that the conductors sit securely in the terminal points.

6.12 Connection to the multifunction relay X12/X13

6.12.1 Digital output X12 (MFR)

The multifunction relay (MFR) is a digital output that can be specifically configured to the system. The three digital outputs **X12** and **X13** are change-over contacts via which the appropriate remote terminal can be controlled.

In a system with multiple SMA Data Managers, you must carry out the connection to the multifunction relay of the System Manager.

6.12.2 Pin assignment X12 (MFR)

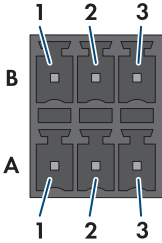
Digital output X12	Row (User interface)	Pin	Assignment
	B (Digital output 4)	1	Make contact (open when idle)
		2	COM (common contact)
		3	Break contact (closed when idle)
	A (Digital output 3)	1	Make contact (open when idle)
		2	COM (common contact)
		3	Break contact (closed when idle)

6.12.3 Pin assignment X13 (MFR)

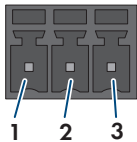
Digital output X13	Row (User interface)	Pin	Assignment
	A (Digital output 5)	1	Make contact (open when idle)
	2	COM (common contact)	
	3	Break contact (closed when idle)	

6.12.4 Circuitry overview X12/X13

SMA Data Manager

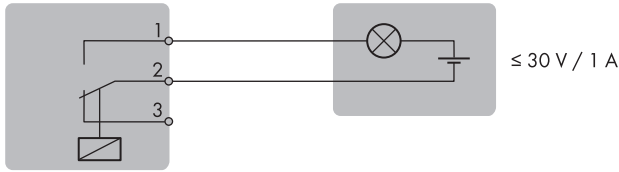

Figure 18: Connection example of a multifunction relay / row A and B

6.12.5 Connecting signal source to X12/X13

⚠ QUALIFIED PERSON

Requirements:

- The technical requirements of the multifunction relay must be met (see Section 12, page 77).

Procedure:

1. Connect the connection cable to the digital signal source (see the manual from manufacturer).
2. Connect the connection cable to the supplied 3-pole connector. Ensure that the conductors are plugged completely into the terminal points up to their insulation.

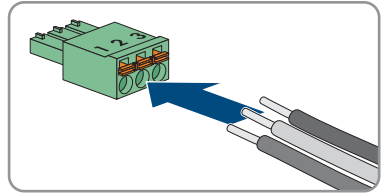

3. Plug the 5-pole connector into the sockets **X12** or **X13** on the product. Observe the pin assignment.
4. Ensure that the connector is securely in place.
5. Ensure that all conductors are correctly connected.
6. Ensure that the conductors sit securely in the terminal points.

6.13 Connection to the system network X14/X15

6.13.1 System network X14/X15

You can connect SMA products such as PV inverters via SMA Speedwire or Modbus devices via Modbus TCP to the network ports **X14** and **X15**.

6.13.2 Connecting network cables to X14/X15

QUALIFIED PERSON

Interference in data transmission due to unshielded power cables

If unshielded power cables are used, they generate an electromagnetic field during operation which may induce interference in network cables during data transmission.

- When laying network cables without separating strip, observe a minimum clearance of 200 mm (8 in) to unshielded energy cables.
- When laying network cables with separating aluminum strip, observe a minimum clearance of 100 mm (4 in) to unshielded energy cables.
- When laying network cables with separating steel strip, observe a minimum clearance of 50 mm (2 in) to unshielded energy cables.

Additionally required material (not included in the scope of delivery):

- One or two network cables

Procedure:

1. Plug the RJ45 plug of the network cable into the network port **X14** or **X15** until the RJ45 plug snaps into place. The assignment of the network cables to the ports is not relevant, as the ports constitute a switch function.
2. Connect the other end of the network cable to the SMA Speedwire device.

6.14 Connection to the Internet X16

6.14.1 Internet X16

You can connect an Internet router to network port **X16**. You can update the firmware of the product and connected devices and monitor your system via Sunny Portal via an active Internet connection.

6.14.2 Connecting network cable to X16

QUALIFIED PERSON

Interference in data transmission due to unshielded power cables

If unshielded power cables are used, they generate an electromagnetic field during operation which may induce interference in network cables during data transmission.

- When laying network cables without separating strip, observe a minimum clearance of 200 mm (8 in) to unshielded energy cables.
- When laying network cables with separating aluminum strip, observe a minimum clearance of 100 mm (4 in) to unshielded energy cables.
- When laying network cables with separating steel strip, observe a minimum clearance of 50 mm (2 in) to unshielded energy cables.

Additionally required material (not included in the scope of delivery):

- 1 network cable

Requirements:

- An Internet router with active Internet connection must be available.

Procedure:

1. Plug the RJ45 connector of the network cable into the network port **X16** until the RJ45 connector snaps into place.
2. Connect the other end of the network cable to a an Internet router.

6.15 Connection to the voltage supply X1

6.15.1 Voltage supply X1

An external power supply unit is needed for the voltage supply which is available as an accessory. In compliance with the requirements on current sources with limited power in accordance with IEC 60950, the power supply unit must not supply more than 30 V and no more than 8 A.

Also see:

- [Accessories](#) ⇒ page 80

6.15.2 PIN assignment X1

Voltage supply X1	Pin	Assignment
	1	Input voltage 10 V DC to 30 V DC
	2	Ground (GND)

6.15.3 Circuitry overview X1

SMA Data Manager

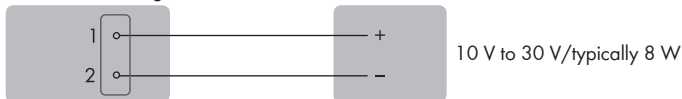

Figure 19: Connecting the Voltage Supply

6.15.4 Connecting the voltage supply to X1

QUALIFIED PERSON

WARNING

Danger to life due to electric shock

Under fault conditions, when working on the power supply circuit there may be dangerous voltages present on the product. This can result in death or serious injury.

- For power supply units with a fixed connection, make sure that a disconnection unit (e.g. miniature circuit breaker) is present outside the power supply unit.
- For power supply units with a plug connection, make sure that the electrical outlet for the power supply unit is close to the power supply unit.
- The disconnection unit and the electrical outlet for the power supply unit must be freely accessible at all times.

NOTICE

Damage to the product due to condensation

If the product is moved from a cold environment to a warm environment, condensation may form in the product. This can damage the product or impair its functionality.

- When there are large temperature differences, wait until the product has reached room temperature to connect the voltage supply.
- Make sure the product is dry.

Additionally required material (not included in the scope of delivery):

- 1 power supply unit
- 1 AC connection cable
- 1 connection cable for the connection of the power supply unit to the product

Requirements for power supply unit:

- Short-circuit current: < 8 A
- Nominal output power: typically 8 W
- DC output voltage: 10 V to 30 V
- Compliance with the requirements on current sources with limited power in accordance with IEC 60950

Requirements:

- All devices must be correctly connected.

Procedure:

1. Mount the power supply unit (see the manufacturer manual).
2. Connect the connection cable to the supplied two-pole plug. Ensure that the conductors are plugged completely into the terminal points up to their insulation.
3. Trim unused insulated conductors flush with the cable sheath.

4. Connect the connection cable to the power supply unit (see the manufacturer manual). Make a note of the insulated conductor colors and trim the unused insulated conductors back to the cable sheath.
5. Plug the 2-pole connector into the socket **X1** on the product. Observe the pin assignment.
6. Connect the AC connection cable to the power supply unit (see the manufacturer manual).

7.

 **WARNING**

Danger to life due to electric shock

Lethal voltages are present at the connection point of the utility grid.

- Disconnect the connection point from voltage sources and ensure that the connection point is voltage-free.

8. Connect the other end of the AC connection cable to the voltage supply.
 9. Connect the connection point to the utility grid.
- The product starts operation.

7 Commissioning

7.1 Requirements for Commissioning

- All devices in the local network must be in operation and connected to the product via an Internet router.
- There must be an active Internet connection.
- An NTP server must be available in the local network or via the Internet. If there is no NTP server available, the time set in the web browser can be used as system time.

i Restart at different system time

An NTP server must be available in the local network or via the Internet. If there is no NTP server available, the time set in the web browser is used as system time. If the difference between the time in the web browser and the system time is more than one minute, the time is synchronized and the product restarted.

7.2 Changing the Network Configuration

After you connect to the user interface for the first time, the welcome page opens.

On the welcome page, you can change the network configuration. The automatic network configuration recommended by SMA Solar Technology AG via DHCP server is activated by default. Only change the network configurations if the default configuration is not suitable for your network.

Procedure:

1. Select [**Change network configuration**] on the welcome page.
2. Carry out network configuration and confirm with [**Save**].

7.3 Starting the Installation Assistant

The installation assistant guides you step-by-step through the initial configuration of the product.

Procedure:

1. Click on [**Next**] on the welcome page.
2. Create administrator account and select [**Next**]. Observe that only one user with administrator authorization can be created on each Data Manager.
 - The installation assistant will open.
3. Follow the installation assistant steps listed and make the settings appropriate for your system.
 - A successful commissioning is confirmed by a message.

7.4 Establishing a connection to the user interface

7.4.1 Connection in the local network

7.4.1.1 Access addresses for the product in the local network

i DHCP Server is recommended

The DHCP server automatically assigns the appropriate network settings to your nodes in the local network. A manual network configuration is therefore not necessary. In a local network, the Internet router is usually the DHCP server. If the IP addresses in the local network are to be assigned dynamically, DHCP must be activated in the Internet router (see the Internet router manual). In order to receive the same IP address by the internet router after a restart, set the MAC address binding.

In networks where no DHCP server is active, proper IP addresses must be assigned from the free address pool of the network segment to all network participants to be integrated during commissioning.

i Communication disturbances in the local network

The IP address range 192.168.12.0 to 192.168.12.255 is occupied for communication amongst SMA products and for direct access to SMA products.

Communication problems might occur if this IP address range is used in the local network.

- Do not use the IP address range 192.168.12.0 to 192.168.12.255 in the local network.

If the product is connected to a local network (e.g. via an Internet router or Wi-Fi), the product will receive a new IP address. Depending on the type of configuration, the new IP address will be assigned automatically by the DHCP server (Internet router) or manually by you.

Upon completion of the configuration, the product can only be reached via the listed access addresses in the local network:

- Generally applicable access address: IP address manually assigned or assigned by the DHCP server (Internet router) (identification via network scanner software or network configuration of the Internet router).
- Access address: **https://SMA[serial number]** (e.g. **https://SMA0123456789**)

7.4.1.2 Ports for data communication in the local network

In small local networks the use of certain ports is unrestricted. In industrial networks, the use of these ports may require authorization from the system administrator. For proper operation, the outgoing Internet connection must allow the use of the following ports and URLs:

Port and URL	Use
Port 21 (FTP)	FTP push
Port 80 and 443 (http/https) update.sunnyportal.de	Updates
Port 123 (NTP) ntp.sunny-portal.com	Time synchronization with Sunny Portal (if not provided by the Internet router)

Port and URL	Use
Port 443 (https/TLS) ldm-devapi.sunnyportal.com	Data transmission
Port 443 (https/TLS) ennexos.sunnyportal.com	User interface
Port 9524 (TCP) wco.sunnyportal.com	SMA Webconnect 1.5, SMA SPOT and SMA Live-View

7.4.1.3 Establishing a connection in the local network

Requirements:

- The product must be commissioned.
- The product must be connected to the local network (e.g., via a router).
- The product must be integrated into the local network. Tip: You can change the network configuration on the welcome page of the product.
- A smart terminal device (e.g. laptop) must be available.
- The smart terminal device must be in the same local network as the product.
- The respective latest version of one of the following web browsers must be installed on the smart terminal device: Chrome, Edge, Firefox or Safari.

Procedure:

1. Open the web browser of your smart terminal device.
2. Enter the access address of the product in the address bar of the web browser.

3. ** Web browser displays warning**

After the access address of the product has been entered, a message might appear indicating that the connection to the user interface of the product is not secure.

- Continue loading the user interface (scroll to bottom and click proceed/advance).
- When you connect to the user interface for the first time, the welcome page opens. The Commissioning Assistant for configuring the product can be started via the welcome page.
- The login page of the user interface opens if the product has already been configured.

Also see:

- [SMA Speedwire](#) ⇒ page 21
- [Access addresses for the product in the local network](#) ⇒ page 51

7.4.2 Direct connection via Wi-Fi

7.4.2.1 Connection options for Wi-Fi direct connection

You have several options to connect the product to a smart terminal (e.g. laptop). The procedure can be different depending on the end devices. If the procedures described do not apply to your end device, establish the direct connection via Wi-Fi as described in the manual of your end device.

The following connection options are available:

- Establishing a direct Wi-Fi connection by entering the Wi-Fi data from the type label
- Establishing a direct Wi-Fi connection by scanning the QR code from the device label

7.4.2.2 Access information for direct Wi-Fi connection

Communication disturbances in the local network

The IP address range 192.168.12.0 to 192.168.12.255 is occupied for communication amongst SMA products and for direct access to SMA products.

Communication problems might occur if this IP address range is used in the local network.

- Do not use the IP address range 192.168.12.0 to 192.168.12.255 in the local network.

Access information for the direct WiFi connection can be found below:

- SSID: **SMA[serial number]** (e.g., SMA0123456789)
- Device-specific Wi-Fi password: WPA2-PSK (see type label of the product)
- Default access address: **https://192.168.12.3**

7.4.2.3 Establishing a direct Wi-Fi connection by entering the Wi-Fi data

Requirements:

- A smart terminal (e.g. laptop) must be available.

Procedure:

1. Activate the Wi-Fi access point on the product. Tap on the enclosure lid of the product twice.
 - The COM LED is intermittently flashing orange and green for approx. 5 seconds. The Wi-Fi access point is then activated for approx. 30 minutes. Once this period has expired, the Wi-Fi access point is deactivated automatically.
2. Search for Wi-Fi networks with your smart device.
3. Select the SSID of the product **SMA[serial number]** in the list with the detected Wi-Fi networks.
4. Enter the device-specific Wi-Fi password (see WPA2-PSK on the type label).
5. Open the web browser of your smart terminal and enter the IP address **https://192.168.12.3** into the address bar or, if your smart terminal supports MSDNs services, **SMA[serialnumber].local** or **https://SMA[serialnumber]**.
 - When you connect to the user interface for the first time, the welcome page opens. The Commissioning Assistant for configuring the product can be started via the welcome page.
 - The login page of the user interface opens if the product has already been configured.

7.4.2.4 Establishing a direct Wi-Fi connection by scanning the QR code

Requirements:

- A smart terminal (e.g. laptop) must be available.

Procedure:

1. Activate the Wi-Fi access point on the product. Tap on the enclosure lid of the product twice.
 - The COM LED is intermittently flashing orange and green for approx. 5 seconds. The Wi-Fi access point is then activated for approx. 30 minutes. Once this period has expired, the Wi-Fi access point is deactivated automatically.
2. Scan the QR code on the device label using your terminal.
3. Confirm the connection to the Wi-Fi access point of the product on your terminal. It may be necessary to deactivate the mobile data connection on your smart terminal.
4. Open the web browser of your smart terminal and enter the IP address **https://192.168.12.3** into the address bar or, if your smart terminal supports MSDNs services, **SMA[serialnumber].local** or **https://SMA[serialnumber]**. Or, to open the user interface directly, scan the right QR code on the label included in the delivery using your smart terminal.
 - When you connect to the user interface for the first time, the welcome page opens. The Commissioning Assistant for configuring the product can be started via the welcome page.
 - The login page of the user interface opens if the product has already been configured.

7.5 Registration in Sunny Portal

7.5.1 Profiles for data communication

Different profiles are available to control the intensity of data communication in the system.

The profiles can be edited in the system properties at any time in Sunny Portal to adjust the intensity. Note that when switching from a low to a high intensity data communication, the data from the past is not retroactively adjusted. The adjustment applies from the date of the change.

The following profile can be selected for data communication:

Profile	Explanation
High (default setting)	Devices send all relevant data to the Sunny Portal every 5 minutes.
Medium	Devices send all relevant data to the Sunny Portal every 15 minutes.
Low	Devices send the most important data to the Sunny Portal 6 times per day.

7.5.2 Register as a new user in Sunny Portal

Requirements:

- An active Internet connection must be established.

Procedure:

1. Call up the Internet address <https://ennexOS.SunnyPortal.com> in the web browser.
2. Select **Register**.
3. Enter the necessary data for registration.

4. Select [**Register**].
 - After a few minutes you will receive an e-mail containing a confirmation link for registration in Sunny Portal.
5. If you have not received an e-mail from Sunny Portal, check whether the e-mail has been redirected to a folder for junk mail or whether an incorrect e-mail address has been entered.
6. Follow the confirmation link in the e-mail within 48 hours.
 - Sunny Portal opens a separate window to confirm successful registration.
7. Call up the Internet address <https://ennexOS.SunnyPortal.com> in the web browser.
8. Enter the e-mail address and the Sunny Portal password in the fields **User** and **Password**.
9. Select [**Login**].

7.5.3 Log in to Sunny Portal as an existing user

Requirement:

- You must have access to a user account in Sunny Portal, Sunny Places or Sunny Design.
- An active Internet connection must be established.

Procedure:

1. Call up the Internet address <https://ennexOS.SunnyPortal.com> in the web browser.
2. Enter the e-mail address and the Sunny Portal password in the fields **User** and **Password**.
3. Select [**Login**].

7.5.4 Create new PV system

The system setup assistant is a step-by-step guide to the processes required for the registration of your system in Sunny Portal. In systems with a superordinate and subordinate System Manager, all System Manager can be registered in one step.

Service access

To ensure the best service quality possible, activate the switch for service access during registration.

Requirements:

- You must have access to a user account in Sunny Portal, Sunny Places or Sunny Design.
- The registration ID (RID), the product identification code (PIC) and the Internet address from the device label must be available.
- The product must be in operation and connected to the local network via an Internet router.
- The system LED must glow green.
- An active Internet connection must be established.

Procedure:

1. Log into Sunny Portal.
2. Select the menu **Configuration**.

3. Select [**Create system**] in the context menu.
 - The system setup assistant opens.
4. Follow the instructions of the PV System Setup Assistant.
5. When registering devices, click on the button  to register several SMA System Manager and select [**Next**].
6. Continue to follow the instructions of the system setup assistant and select [**Save**].

7.5.5 Add product to an existing system

Requirements:

- You must have access to a user account in Sunny Portal, Sunny Places or Sunny Design.
- The registration ID (RID), the product identification code (PIC) and the Internet address from the device label must be available.
- The product must be in operation and connected to the local network via an Internet router.
- The system LED must glow green.
- An active Internet connection must be established.

Procedure:

1. Log into Sunny Portal.
2. Select system.
3. Select the menu **Configuration**.
4. Select [**Device management**] in the context menu.
5. Select the  button.
 - The system setup assistant opens.

8 Operation

8.1 Design of the User Interface

The user interface of the product and the user interface of Sunny Portal are uniform.

The product is configured and commissioned on site via the user interface of the product.

The Sunny Portal serves as the user interface for the extended configuration of the product, of system sections, systems, system groups and the entire system portfolio. The Sunny Portal monitors and analyzes the system and its components on all levels.

The number of functions and menus depends on whether you are on the local user interface of the product or in Sunny Portal.



Figure 20: Design of the user interface (example)

Position	Designation	Description
A	Focus navigation	Enables the navigation between the following levels: <ul style="list-style-type: none"> • System • Device
B	User settings	Provides the following functions: <ul style="list-style-type: none"> • Configuring personal data • Logout
C	System information	Displays the following information: <ul style="list-style-type: none"> • System • Device information • Licenses • eManual

Position	Designation	Description
D	Content Area	Displays the dashboard or content of the selected menu.
E	Configuration	Offers different configuration options, depending on the scope of the connected devices and the selected level.
F	Monitoring	Displays depending on the selected device the following information on the current level and the superior levels: <ul style="list-style-type: none"> • Energy and power • Instantaneous values • Status list • Event monitor
G	Dashboard	Displays information and instantaneous values of the device or system currently selected.
H	Home	Opens the user interface home page

8.2 Access rights to the user interface

1 administrator is created during registration. As administrator, you can add further system users who can configure user rights or delete users.

This gives users access to the system and to the devices recorded in the system.

You can assign the following rights for users:

- Administrator
- User
- Installer

8.3 Device Administration

8.3.1 Register Devices

You can register new devices and add them to the system on system level. This is required, for example, if your system has been expanded.

Requirements:

- The user interface must be open and you must be logged in.

Procedure:

1. Select the system in the focus navigation.
2. Select the menu **Configuration**.
3. Select the **Device management** menu item.

4. Select the  button.
5. Follow the steps of the device registration wizard.

8.3.2 Delete devices

You can delete registered devices on system level.

Requirements:

- The user interface must be open and you must be logged in.

Procedure:

1. Select the system in the focus navigation.
2. Select the menu **Configuration**.
3. Select the **Device management** menu item.
4. In the row of the device to be deleted, click the **---** button.
5. Select **Delete device**.
6. Select [**Delete**] in the displayed message.

8.4 Backup file

8.4.1 Function and content of the backup file

The backup file is used to transfer configuration information, e.g., when commissioning a replacement device or when restoring previously saved parameter settings.

The backup file includes the following system and device configuration data for your product:

- Grid management services
- FTP
- Network
- Sensors
- Analog and digital inputs
- Analog and digital outputs
- Energy meter
- Sunny Portal setting
- Self-defined Modbus profiles
- System password
- User interface login data
- List of connected devices

The following information is not included in the backup file:

- Notifications
- Historic energy and performance values
- Configuration of individual inverters

8.4.2 Creating a Backup File

Requirements:

- The user interface must be open and you must be logged in.

Procedure:

1. Select the product in the focus navigation.
2. Select the menu **Configuration**.
3. Select the **Update and backup** menu item.
4. Select the [**Create backup file**] button.
5. Enter a password to encrypt the backup file and confirm with [**Create and download backup file**]. Please note that the password will be needed later for importing the backup file.
 - An lbd file with all parameter settings is downloaded.

Also see:

- [Function and content of the backup file](#) ⇒ page 59

8.4.3 Upload backup file

QUALIFIED PERSON

Requirements:

- The backup file and the corresponding password must be available.

Procedure:

1. Open the user interface.
2. Log into the user interface.
 - After you connect to the user interface of the product for the first time, the installation assistant opens.
3. If the installation assistant does not open, reset the product to the default settings.
4. On the first page of the installation assistant in the row **Device function**, select the option [**Start restoration**].
5. Select the desired backup file and enter the backup file password.
6. Confirm with [**Upload backup file**].
 - The lbd file with all parameter settings will be uploaded to the product. The product restarts automatically. This process can take several minutes.

Also see:

- [Function and content of the backup file](#) ⇒ page 59
- [Resetting the product to default setting](#) ⇒ page 61

8.5 Resetting the product to default setting

Loss of data due to replacement or due to resetting to default settings

If the product is reset to the default settings or replaced, all data saved in the product and the admin account will be deleted. Some of the data saved in Sunny Portal can be transmitted to the product after calling up the Sunny Portal system again.

Requirements:

- The user interface must be open and you must be logged in.

Procedure:

1. Select the product in the focus navigation.
2. Select the menu **Configuration**.
3. Select the menu item **Device properties**.
4. Select the button [**If you want to reset the device to the default settings, click here**].
5. Select [**Reset**].

8.6 Deleting the Admin Account

QUALIFIED PERSON

In case the password gets lost, the admin account can be reset and newly created. All system data will be retained.

Requirements:

- The login page of the user interface must be open.

Procedure:

1. Select the [**Delete admin account?**] button.
 2. Enter the device key from the device label.
 3. Select [**Delete**].
- The product is performing a restart. Then a new admin account can be created.

Also see:

- [Device Key \(DEV KEY\) ⇒ page 24](#)

8.7 Firmware Update

8.7.1 Carry out a manual firmware update

QUALIFIED PERSON

Functional limitations during the update

While an update is being performed, the functions of the product may be limited. The product is performing a restart and may be without function at times. This process takes several minutes and cannot be canceled.

Requirements:

- An update file with the desired firmware of the product must be available. You can download the update file, for example, from the product page under www.SMA-Solar.com.
- The user interface must be open and you must be logged in as **Installer** or **Administrator**.

Procedure:

1. Select the product in the focus navigation.
2. Select the menu **Configuration**.
3. Select the **Update and backup** menu item.
4. In the **Manual update** area, click [**Select file**] and select the update file for the product.
 - The user interface confirms that the update file is compatible.
5. If the user interface does not confirm the compatibility of the update file, replace the update file.
6. Select [**Start update**].
7. Follow the instructions in the dialog.
 - The product is performing a restart after the firmware update.
8. Select the **Monitoring** menu.
9. Select the menu item **Event monitor**.
10. Check the events to see whether the firmware update has been completed successfully.

8.7.2 Automatically Updating the Firmware

By activating the automatic firmware update, the product searches and installs new firmware versions automatically provided an Internet connection exists. In the process, an available firmware update may take up to 48 hours.

i Functional limitations during the update

While an update is being performed, the functions of the product may be limited. The product is performing a restart and may be without function at times. This process takes several minutes and cannot be canceled.

The automatic firmware update can be activated via the user interface during commissioning.

Requirements:

- The user interface must be open and you must be logged in as **Installer** or **Administrator**.

Procedure:

1. Select the product in the focus navigation.
2. Select the menu **Configuration**.
3. Select the **Parameters** menu item.
4. Select the value **Yes** for the parameter **Automatic updates enabled**.
5. Click on [**Save**].

8.7.3 Automatically updating the firmware of connected devices

By activating the automatic firmware update, the product searches and installs new firmware versions of connected SMA products automatically provided an Internet connection exists. In the process, an available firmware update may take up to 48 hours.

The automatic firmware update can be activated via the user interface during commissioning.

i Firmware updates despite disabled automatic firmware update

The automatic firmware update is installed on connected SMA products even if the automatic firmware update function is disabled in the parameters of the connected SMA products.

- Only perform the automatic firmware update for connected SMA products if firmware updates are to be installed.

i Functional limitations during the update

While an update is being performed, the functions of the product may be limited. The product is performing a restart and may be without function at times. This process takes several minutes and cannot be canceled.

Requirements:

- The user interface must be open and you must be logged in as **Installer** or **Administrator**.
- The connected SMA products must support automatic firmware updates via the product.

Procedure:

1. Select the product in the focus navigation.
2. Select the menu **Configuration**.
3. Select the **Parameters** menu item.
4. Select the value **Yes** for the parameter **Device updates enabled**. This disables the automatic firmware update function in the parameters of the connected SMA products.
5. Click on **[Save]**.

8.8 Grid management service

8.8.1 Active Power Limitation

You can implement grid operator specifications for the limitation of the active power feed-in from 0% to 100% in your system. The setpoint for limitation of active power feed-in is specified in percent. The total system power is taken as the reference value. If your grid operator requires the system not to feed in any active power, you must limit the active power feed-in to a fixed value of 0% and additionally adjust the preset value for the active power gradient. Thus, it is possible to limit the active power feed-in to 0% within a few seconds. To compensate for load step changes and to establish a safety distance to the active power limitation, a negative value can be set. This achieves a timely limitation of the active power feed-in. The value for the limitation of the active power feed-in should be adjusted to the load step changes accordingly. No further inverter settings are necessary.

8.8.2 Configuring active and reactive power setpoints

QUALIFIED PERSON

Supported inverters for the limitation of the active power feed-in to 0%

The limitation of the active power feed-in to 0% are only supported by inverters that support the fallback function. In the event of a communication failure between the product and the inverter, the inverter is reduced to an output power of 0% during fallback). For more information see the inverter manual at www.SMA-Solar.com.

Requirements:

- The configuration for the active power limitation must be agreed upon with the responsible grid operator.
- There must be an appropriate energy meter installed at the grid-connection point within the system.
- The user interface must be open and you must be logged in as **Installer** or **Administrator**.

Procedure:

1. Select the system in the focus navigation.
2. Select the menu item **Grid management service** in the menu **Configuration**.
3. Select the button **Configuration & activation** in the **Active and reactive power** row.
 - The installation assistant will open.
4. Make the settings for **Grid settings**, **Active power** and **Reactive power** according to the specifications required by the grid operator and laid down in the standards and confirm each with [**Next**].
5. Click on [**Save**].

8.8.3 Configure additional specifications from the grid operator for the country data set.

QUALIFIED PERSON

During device registration, the required country data sets are selected for the detected devices. To achieve the correct control speed for the country data set, you need to make additional settings.

Requirements:

- The user interface must be open and you must be logged in as **Installer** or **Administrator**.

Procedure:

1. Select the system in the focus navigation.
2. Select the menu item **Grid management service** in the menu **Configuration**.
3. Select the button **Configuration & activation** in the **Active and reactive power** row.
4. Open the configuration wizard for **Grid operator specifications** under **Active power**.
5. In case of a manual setpoint, activate **Manual setpoint for active power limitation** and enter the active power limitation specified by the grid operator.

6. In case of an external setpoint, activate **Source for external setpoint** and select the applicable options.
7. Activate **Behavior in case of setpoint change**.
8. Select **Implementation with PT1 element** and enter the value 0.2 s in the field **Setting time**.
9. Select **Gradient** and enter the value 500%/s for **Max. increase of the default value** and **Max. decrease of the default value**.
10. Click on [**Next**].
11. Click on [**Save**].

Also see:

- [Register Devices](#) ⇒ page 58

8.8.4 Configure additional direct seller's specifications for the country data set.

QUALIFIED PERSON

During device registration, the required country data sets are selected for the detected devices. To achieve the correct control speed for the country data set, you need to make additional settings.

Requirements:

- The user interface must be open and you must be logged in as **Installer** or **Administrator**.

Procedure:

1. Select the system in the focus navigation.
2. Select the menu item **Grid management service** in the menu **Configuration**.
3. Select the button **Configuration & activation** in the **Active and reactive power** row.
4. Open the configuration wizard for **Direct seller settings** under **Active power**.
5. Under the **Direct seller settings**, activate the **Source for external setpoint** and select one of the available options.
6. Activate **Behavior in case of setpoint change**.
7. Select **Implementation with PT1 element** and enter the value 0.2 s in the field **Setting time**.
8. Select **Gradient** and enter the value 500%/s for **Max. increase of the default value** and **Max. decrease of the default value**.
9. Click on [**Next**].
10. Click on [**Save**].

Also see:

- [Register Devices](#) ⇒ page 58

8.9 Modbus

8.9.1 SMA Modbus Profile

Connected Modbus devices can be used, for example, as energy meters for generation and consumption data at the grid-connection point or for energy monitoring. For this, predefined Modbus profiles, user-created Modbus profiles or the SunSpec Modbus profile must be used. The Modbus profiles will then be assigned to the Modbus devices.

i IP addresses of Modbus devices

In systems with Modbus devices, static IP addresses must be assigned to all Modbus devices. Suitable IP addresses can be assigned to the Modbus devices from the free address supply of the network segment either manually or dynamically via DHCP.

If the IP addresses are to be assigned dynamically, DHCP must be activated in the Internet router (see the Internet router manual). Make sure that the Modbus devices do not contain variable IP addresses but always the same IP addresses (static DHCP).

This also applies to Data Managers that are used as subordinate devices.

If IP addresses of Modbus devices have been changed, all devices must be restarted.

8.9.2 SunSpec Modbus Profile

The product supports the standardized SunSpec Modbus profile via the interface of the Modbus client (Modbus TCP/RTU). The connected Modbus devices must conform with the SunSpec specification (see manufacturer manual). The mandatory data of the following SunSpec models are supported:

Common model:

- 1, 11, 12

PV inverter:

- 101, 102, 103, 120, 121, 122, 123, 126, 127, 128, 129, 130, 131, 132, 160

Energy meters:

- 201, 202, 203, 204, 211, 212, 213, 214

8.9.3 Creating a New Modbus Profile

Requirements:

- The user interface must be open and you must be logged in as **Installer** or **Administrator**.

Procedure:

1. Select the product in the focus navigation.
2. Select the menu item **Device administration** in the menu **Configuration**.
3. Select the **+** button.
4. Select **Modbus devices** and confirm with [**Next**].
5. Select **Manage Modbus profiles**.

6. Select **Create a new Modbus profile**.
7. Fill out the entry fields and select [**Save**].

8.9.4 Registering a New Modbus Device and Assigning a Modbus Profile

Requirements:

- The user interface must be open and you must be logged in as **Installer** or **Administrator**.
- The connected Modbus devices must be configured to send their setpoints in cyclic intervals (maximum cycle time: 1 minute; recommended cycle time: 1 second).
- The Modbus devices must be in operation and connected to the product.

Procedure:

1. Select the product in the focus navigation.
2. Select the menu item **Device administration** in the menu **Configuration**.
3. Select the **+** button.
4. Select **Modbus devices** and confirm with [**Next**].
5. Fill out the input fields and confirm with [**Next**].
 - Available Modbus devices in the system are searched for and displayed.
6. Select the Modbus devices to be added to the system and select [**Save**].
- The connected Modbus device can be used as an energy meter for generation and consumption data at the point of interconnection, for energy monitoring or as sensor for wind speed, solar irradiation, and temperature.

8.10 Limiting-value based switching

8.10.1 Operators for limit-based switching

The digital outputs of connected I/O systems can be switched depending on measured values or states. In this way, heat pumps or relays, for example, can be controlled by specifying a defined output. A tolerance (hysteresis) dependent on the selected operator prevents the digital outputs from switching even with slight power fluctuations.

Operator	Tolerance (hysteresis)
Greater than or equal to (\geq)	$\pm 5 \%$
Less than or equal to (\leq)	$\pm 5 \%$
Equal to	$\pm 5 \%$

8.10.2 Parameter for limit-based switching

The following limits and parameters are available for limit-based switching:

- Direct selling enabled
- Notification in the event of an error
- Alarm in case of warning or error

- System active power (grid-supplied power)
- System active power (grid feed-in)
- System reactive power at the point of interconnection
- Standardized measured voltage value for Q(V)
- Reactive power setpoint
- Setpoint of active power limitation
- Battery state of charge
- System active power
- System reactive power

8.10.3 Switch digital outputs based on thresholds

Requirements:

- The user interface must be open and you must be logged in as **Installer** or **Administrator**.

Procedure:

1. Select the system in the focus navigation.
2. Select the menu item **I/O configurations** in the **Configuration** menu.
3. In the **Manage I/O configurations** menu select the button **New I/O configuration**.
4. To configure the digital outputs of a connected device, select the option button **Digital output**.
5. Fill out the entry fields and select [**Save**].

8.11 Speedwire encryption

8.11.1 Speedwire Encryption of the System Communication

Speedwire encryption is used to encrypt system communication between all compatible Speedwire devices. In order to be able to use the Speedwire encryption in the system, all connected Speedwire devices, apart from the SMA Energy Meter, must support the SMA Speedwire Encrypted Communication function.

Speedwire encryption for systems with one Data Manager

In systems with more than one Data Manager, there can be overlaps in the system encryption.

- Only enable the Speedwire encryption in systems with one Data Manager.

8.11.2 Enabling Speedwire Encryption

QUALIFIED PERSON

Requirements:

- All devices in the local network must be in operation and connected to the product via an Internet router.
- All devices must support the Speedwire encryption.

- The user interface must be open and you must be logged in.

Procedure:

1. Select the system in the focus navigation.
2. Select the menu **Configuration**.
3. Select the **Device management** menu item.
4. Select the **+** button.
5. Select **SMA Speedwire devices** and confirm with **[Next]**.
 - All SMA Speedwire devices in the systems are searched for and displayed.
6. Enable SMA Speedwire encryption and select **[Continue]**.
7. Assign a new system password and select **[Save]**.

8.12 Fallback Behavior

8.12.1 Function of the fallback behavior

If communication fails for a specific time, either the last communicated values are kept or predefined fallback values are taken. This function is referred to as fallback behavior (fallback). Interruptions in the communication are shown via notifications in Sunny Portal if the system is registered in Sunny Portal. Fallback times should be set at a ratio of 1:3. For example, for the cyclical sending of remote signals of 10 s, a fallback time of 30 s should be set. Fallback values (in watt) must be set in accordance with the grid operator's specifications. As soon as communication is restored, it automatically switches to the previous operating mode.

8.12.2 Fallback behavior in the event of communication failure to the digital inputs

This fallback behavior occurs when invalid or non-configured signals are received at the digital inputs (internal or external). When using temporary pulse signals at the digital inputs, no fallback values may be defined. Pulse signals are impulses of a ripple control receiver that are only present for 1 s to 1.5 s. These pulse signals can only be analyzed when directly connected to the Data Manager. When using external I/O systems, this is not possible.

8.12.3 Fallback behavior in the event of communication failure to the energy meter at the point of interconnection

This fallback behavior occurs when the communication to the energy meter at the point of interconnection is interrupted. In the event of an interruption in communication, there is a switchover from closed-loop to open-loop control mode. This ensures that any curtailment is passed on directly to the connected inverters, even if self-consumption is then no longer taken into account. The fallback behavior is enabled by default and cannot be disabled.

8.12.4 Fallback behavior in reactive power mode

The fallback behaviors for reactive power mode can be set more detailed than for active power mode (see technical information "SMA GRID GUARD 10.0 - Grid Management Services via Inverter and System Controller" at www.SMA-Solar.com).

8.13 Replace the SMA Data Manager M (EDMM-10) with the SMA Data Manager M (EDMM-20)

QUALIFIED PERSON

The product can be used in systems with an SMA Data Manager M (EDMM-10). In addition, all parameter settings of the SMA Data Manager M (EDMM-10) can be uploaded to the product. The backup file of an SMA Data Manager M (EDMM-10) cannot be transferred.

Requirements:

- The user interface must be open and you must be logged in as **Installer** or **Administrator**.

Procedure:

1. Select the system in the focus navigation.
2. Select the menu item **Parameter** in the menu **Configuration**.
3. To download the parameters of the SMA Data Manager M (EDMM-10), select the **[Download]** button and confirm with **[Download now]**.

4. **WARNING**

Danger to life due to electric shock

Lethal voltages are present at the connection point of the utility grid.

- Disconnect the connection point from the utility grid using the separator (e.g. miniature circuit breaker).

5. Pull the two-pole power supply unit connectors out of the socket **X1** on the SMA Data Manager M (EDMM-10).
6. Release the RJ45 connector of the network cable and pull out of the network port **X4** or **X5** on the SMA Data Manager M (EDMM-10).
7. Pull all other connectors out of the sockets on the SMA Data Manager M (EDMM-10).
8. If mounted on a DIN rail: to detach the SMA Data Manager M (EDMM-10) from the DIN rail, unlock both lower base latches using a suitable tool. Tilt the lower edge of the SMA Data Manager M (EDMM-10) forward and lift the SMA Data Manager M (EDMM-10) up and off the DIN rail.
9. If mounted on a wall: remove the screws from the base latches and remove the SMA Data Manager M (EDMM-10).
10. If the SMA Data Manager M (EDMM-10) is to be disposed of, dispose of the SMA Data Manager M (EDMM-10) in accordance with the locally applicable disposal regulations for electronic waste.
11. Mount the product (see Section 5, page 25).
12. Connect all plugs to the product (see Section 6, page 28).
13. Commission the product (see Section 7, page 50).
14. Add all devices connected to the SMA Data Manager M (EDMM-10) to the new SMA Data Manager M (EDMM-20) again.
15. In the **Configuration** menu, select the menu item **Device parameter adjustment**.

16. Click the button [**System parameter assistant**].
17. Follow the steps of the system parameter assistant and transfer the saved parameters of the SMA Data Manager M (EDMM-10) to the new SMA Data Manager M (EDMM-20).
18. Register the system in the Sunny Portal powered by ennexOS and, if needed, replace the SMA Data Manager (see the manual for Sunny Portal powered by ennexOS).

9 Troubleshooting

9.1 Obsolete or incorrect measured values are displayed

Cause	Remedy
Connection to VPN or Internet is disrupted.	<ul style="list-style-type: none"> Ensure that the network cable is connected correctly and that the network port Link LED is glowing. <p>or</p> <ul style="list-style-type: none"> Check the status of the connected devices in the device overview in Sunny Portal.
The energy meter is connected incorrectly.	<ul style="list-style-type: none"> Connect the energy meter correctly (see energy meter manual). <p>or</p> <ul style="list-style-type: none"> Swap the channels for purchased-electricity and feed-in meters in the meter configuration on the user interface. <p>or</p> <ul style="list-style-type: none"> In the meter configuration on the user interface select an inverse profile.
The display in your web browser is not updated.	<ul style="list-style-type: none"> Reload the page in your web browser.

9.2 Not all devices are being detected

Cause	Remedy
Not all devices are in operation.	<ul style="list-style-type: none"> Ensure that all devices are in operation.
There are too many devices in the system.	<ul style="list-style-type: none"> Ensure that no more than permissible devices are in the system.
The network configuration of the local network is incorrect.	<ul style="list-style-type: none"> Ensure that the network configuration is correct. SMA Solar Technology AG recommends automatic network configuration.
The reaction time of some devices exceeds the device search time.	<ul style="list-style-type: none"> Register all found devices. Then carry out another device search and register the remaining devices.

9.3 The product user interface cannot be called up

Cause	Remedy
The firmware has been updated to a newer version.	<ul style="list-style-type: none"> After a firmware update, errors may arise when restarting the products. Reset the product to the default settings. Press the reset button for 15 to 20 seconds. This will also reset all of the data in the product.

9.4 Parameter changes via the device settings or a parameter adjustment are not confirmed

Cause	Remedy
Connected devices do not send notifications about parameter changes that were made.	<ul style="list-style-type: none"> Check after about 5 minutes whether the parameter change has been accepted. If necessary, repeat the parameter change.
Parameters are modified by 2 users simultaneously.	<ul style="list-style-type: none"> Ensure that parameters cannot be modified at the same time on the user interface of the product and in Sunny Portal.

9.5 The product cannot be registered in Sunny Portal

Cause	Remedy
The Internet connection via a proxy server is not possible.	<ul style="list-style-type: none"> Contact your network administrator.
The PIC or RID entry is incorrect.	<ul style="list-style-type: none"> Verify your entry.

9.6 The firmware of a connected SMA product was not updated during a firmware update

Cause	Remedy
The firmware version downloaded is not the latest or is not suitable for the SMA product.	<ul style="list-style-type: none"> The firmware version must be later than the firmware version installed on the SMA product. Ensure that you have downloaded the correct firmware version for your SMA product and update the firmware again.
The DC input voltage is not sufficient for a firmware update.	<ul style="list-style-type: none"> With older inverters, a firmware update is only possible above a certain DC input voltage. Depending on the time of day, the weather, and the condition of the PV modules (e.g. affected by pollution or covered with snow), the DC input voltage may be too low for a firmware update. Ensure that there is sufficient DC voltage present and update the firmware again.
The transmission quality in the local network is not sufficient.	<ul style="list-style-type: none"> Errors can occur during data transmission if the transmission quality in the local network is too low. Check the network status of your local network and, if necessary, contact your network administrator.

9.7 No data are displayed on the user interface of the product

Cause	Remedy
<p>The buffer capacitor of the product's real-time clock might have discharged due to being without voltage supply for a longer time period.</p>	<ul style="list-style-type: none">• Ensure that the product has access to a time server on the Internet or in the local network to obtain a current time.

10 Decommissioning the Product

⚠ WARNING

Danger to life due to electric shock

Lethal voltages are present at the connection point of the utility grid.

- Disconnect the connection point from the utility grid using the separator (e.g. miniature circuit breaker).

Procedure:

1. Pull the two-pole power supply unit plug out of the jack **X1** on the Data Manager.
2. Unlock all RJ45 connectors of the network cable and pull out of the network ports **X14**, **X15** and **X16** of the Data Manager.
3. Pull all connectors out of the sockets **X3** to **X13** on the Data Manager.
4. If mounted on a DIN rail: to detach the Data Manager from the DIN rail, unlock both lower base latches using a suitable tool. Tilt the lower edge of the Data Manager forwards and lift it up and off the DIN rail.

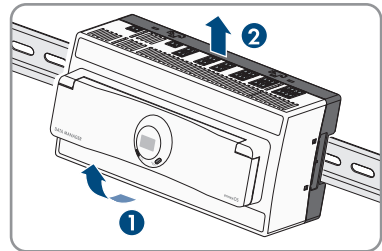

5. If mounted on a wall: remove the screws from the base latches and remove the Data Manager.

Also see:

- Disposal ⇒ page 76

11 Disposal

The product must be disposed of in accordance with the locally applicable disposal regulations for waste electrical and electronic equipment.

12 Technical Data

12.1 Communication

SMA devices	Max. 50 devices, Speedwire, 100 Mbit/s
SunSpec Modbus devices	Max. 50 devices
I/O systems and meters	Ethernet, 10/100 Mbit/s, Modbus TCP
RS485 devices	Modbus RTU (1200 baud, 9600 baud or 19200 baud) / SMA Data 1 (1200 baud and 19200 baud)

12.2 Voltage supply

Connection	2-pole terminal
Voltage supply	External power supply unit in compliance with the requirements on current sources with limited power in accordance with IEC 60950 (available as an accessory)
Input voltage range	10 V DC to 30 V DC
Power consumption	Typically 8 W

12.3 Climatic Conditions

Ambient and storage temperature	-20°C to +60°C (-4°F to +140°F)
Max. permissible value for relative humidity (non-condensing)	5% to 95%
Maximum operating altitude above mean sea level (MSL)	0 m to 3500 m (≥66 kPa)
Degree of protection	IP20 (NEMA 1) (NEMA 1)

12.4 General Data

Dimensions (W x H x D)	216 mm x 90 mm x 68 mm (8.5 in x 3.5 in x 2.7 in)
Weight	372 g (0.82 lb)
Installation site	Indoors
Mounting type	Top-hat rail mounting / wall mounting
Status display	LEDs for system and communication status

12.5 Digital inputs

Number	10 + 1 fast stop
Input voltage	12 V DC
Maximum cable length	< 30 m (98 ft)

12.6 Digital output (multifunction relay)

Number	5
Execution	Potential-free relay contacts
Maximum switching voltage	30 V DC
Maximum switching current	1 A
Minimum switching current	10 mA
Minimum electrical endurance when the maximum switching voltage and maximum switching current are complied with ¹⁾	100000 switching cycles
Bounce time	5 ms
Reset time	5 ms
Maximum cable length	< 30 m (98 ft)

12.7 Analog inputs

Number	4
Measurement range for current signals	0 mA to 20 mA ($\pm 1\%$)
Maximum cable length	< 30 m (98 ft)

12.8 Analog outputs

Number	4
Measurement range for current signals	0 mA to 20 mA ($\pm 1\%$)
Maximum cable length	< 30 m (98 ft)

12.9 Temperature inputs

Number	2 (PT100)
Measuring equipment	2-conductor and 4-conductor
Measurement range	-40°C to +85°C (-40°F to +185°F)
Maximum cable length	< 30 m (98 ft)

¹⁾ Corresponds to 20 years at 12 switching operations per day

12.10 RS485 inputs

Number	2
Maximum cable length	< 1200 m (3937 ft)

12.11 Equipment

Warranty	2 years
Certificates and approvals	www.SMA-Solar.com

13 Accessories

You will find the accessories for your product in the following overview. If required, these can be ordered from SMA Solar Technology AG or your distributor.

Designation	Brief description	SMA order number
Top-hat rail power supply unit ²⁾	DIN rail power supply unit for SMA Data Manager M	CLCON-PWRSUPPLY
ioLogik E1214	I/O system by Moxa Europe GmbH (6DI/6Relay-Out)	124179-00.01

²⁾ Not permitted in all countries (e.g. Japan). For information on whether an accessory is permitted in your country, visit the website of the SMA subsidiary of your country at www.SMA-Solar.com or contact your distributor.

14 Compliance Information

FCC Compliance

This device complies with Part 15 of the FCC Rules and with Industry Canada licence-exempt RSS standard(s).

Operation is subject to the following two conditions:

1. this device may not cause harmful interference, and
2. this device must accept any interference received, including interference that may cause undesired operation.

Le présent appareil est conforme aux CNR d'Industrie Canada applicables aux appareils radio exempts de licence.

L'exploitation est autorisée aux deux conditions suivantes :

1. l'appareil ne doit pas produire de brouillage, et
2. l'utilisateur de l'appareil doit accepter tout brouillage radioélectrique subi, même si le brouillage est susceptible d'en compromettre le fonctionnement.

NOTE: This equipment has been tested and found to comply with the limits for a Class B digital device, pursuant to Part 15 of the FCC Rules. These limits are designed to provide reasonable protection against harmful interference in a residential installation. This equipment generates, uses and can radiate radio frequency energy and, if not installed and used in accordance with the instructions, may cause harmful interference to radio communications. However, there is no guarantee that interference will not occur in a particular installation. If this equipment does cause harmful interference to radio or television reception, which can be determined by turning the equipment off and on, the user is encouraged to try to correct the interference by one or more of the following measures:

- Reorient or relocate the receiving antenna.
- Increase the separation between the equipment and receiver.
- Connect the equipment into an outlet on a circuit different from that to which the receiver is connected.
- Consult the dealer or an experienced radio/TV technician for help.

Changes or modifications made to this equipment not expressly approved by SMA Solar Technology AG may void the FCC authorization to operate this equipment.

RF Exposure Statement

Radiofrequency Radiation Exposure Information:

This equipment complies with FCC radiation limits set forth for an uncontrolled environment. This equipment should be installed and operated with minimum distance of 20 cm (8 in) between the radiator and your body.

IC Compliance

This Class B digital apparatus complies with Canadian ICES-003.

Cet appareil numérique de la classe B est conforme à la norme NMB-003 du Canada.

15 EU Declaration of Conformity

within the scope of the EU directives



- Electromagnetic compatibility 2014/30/EU (29.3.2014 L 96/79-106) (EMC)
- Low Voltage Directive 2014/35/EU (29.3.2014 L 96/357-374) (LVD)
- Radio Equipment Directive 2014/53/EU (22.5.2014 L 153/62) (RED)
- Restriction of the use of certain hazardous substances 2011/65/EU (L 174/88, June 8, 2011) and 2015/863/EU (L 137/10, March 31, 2015) (RoHS)

SMA Solar Technology AG confirms herewith that the products described in this document are in compliance with the fundamental requirements and other relevant provisions of the aforementioned directives. More information on the availability of the entire Declaration of Conformity can be found at <https://www.sma.de/en/ce-ukca>.

Radio technology	WLAN 802.11 b/g/n
Radio spectrum	2.4 GHz
Maximum transmission power	100 mW

16 Contact

If you have technical problems with our products, please contact the SMA Service Line. The following data is required in order to provide you with the necessary assistance:

- Device type
- Serial number
- Firmware version
- Device configuration (System Manager, superordinate System Manager or subordinate System Manager)
- Event message
- Optional equipment (e.g. accessories used)
- Use the name of the system in Sunny Portal (if available)
- Access data for Sunny Portal (if available)
- Information on the ripple control receiver (if available)
- Operating mode of the multifunction relay (if used)
- Detailed description of the problem

You can find your country's contact information at:



<https://go.sma.de/service>



www.SMA-Solar.com

